

GENERAL NOTE

The Transport Planning and Design Manual (the TPDM) consists of eleven volumes and is published primarily as a working document for Transport Department staff. It also provides information and guidance to others involved in the planning and design of transport infrastructures in Hong Kong.

It is intended that the information contained herein will be periodically revised to take account of the most up-to-date knowledge and experience. The inevitable time-lag however, means that certain sections may at a particular time be unavoidably not up-to-date. For this and other reasons, the standards contained in this manual should not be followed rigidly but rather treated as a framework within which professional judgment should be exercised to reach an optimum solution.

Generally speaking, the standards contained in the TPDM generally apply to new traffic and transport facilities and should not be considered as exhaustive. Situation may arise for which considerations and requirements are not fully covered by the TPDM. Practitioners are particularly required to exercise professional judgement when dealing with existing facilities that are subject to site constraints, and to endeavour to take into account the views from stakeholders. Practitioners are also advised to make reference to other publications relevant to their designs such as the latest legislations, code of practices, guidelines, datasets, etc. before applying the TPDM.

Transport Planning & Design Manual

VOLUME 6 - Traffic and Environmental Management

- Chapter 1 - (Not Use)
- Chapter 2 - One-way Streets & Gyratory Systems
 - 2.1 References
 - 2.2 Introduction
 - 2.3 Advantages and Disadvantages of One-way Street Systems
 - 2.4 Design of One-Way Street Systems
 - 2.5 Gyratory System and Associated Transportation Management Techniques
- Chapter 3 - Bus Priority
 - 3.1 References
 - 3.2 Introduction
 - 3.3 Use of Bus Priority
 - 3.4 Types of Bus Priority
 - 3.5 With-Flow Bus Lane
 - 3.6 Contra-Flow Bus Lane
 - 3.7 Bus-Only Streets
 - 3.8 Bus Priority at Junction
 - 3.9 Busway
 - 3.10 "Give way to bus" Scheme
 - 3.11 Evaluation
 - Appendix
- Chapter 4 - (Not Use)
- Chapter 5 - (Not Use)
- Chapter 6 - Speed Limits
 - 6.1 References
 - 6.2 Introduction
 - 6.3 Legislation
 - 6.4 The Use of Speed Limits
 - 6.5 Criteria for Speed Limits
 - 6.6 Review of Existing Speed Limits
 - 6.7 Related Matters
- Chapter 7 - Environmental Considerations
 - 7.1 References
 - 7.2 Introduction
 - 7.3 Air Pollution
 - 7.4 Noise
 - 7.5 Visual Effects
 - Appendix
- Chapter 8 - Facilities for People with Disabilities
 - 8.1 References
 - 8.2 Introduction
 - 8.3 Planning for People with Disabilities
 - 8.4 Crossing Facilities for People with Disabilities
 - 8.5 Parking Facilities
 - 8.6 Road Works and People with Disabilities
 - 8.7 Signing
 - 8.8 Public Transport Services for People with Disabilities
 - 8.9 Public Transport Interchange
 - 8.10 Run-ins
- Chapter 9 - (Not Use)

- Chapter 10 - Pedestrian Planning Framework
 - 10.1 References and Abbreviations
 - 10.2 Introduction
 - 10.3 Highlights of the Overall Walkability Strategy for Hong Kong
 - 10.4 Pedestrian Planning Framework
 - 10.5 Design of Pedestrian Improvement Measures
 - 10.6 Performance Review
 - 10.7 Development of Pedestrian Wayfinding Signage System for Hong Kong
 - Appendix A
 - Appendix B

TPDM Volume 6 Chapter 2 – One-way Streets & Gyratory Systems

2.1 References

- (1) Traffic Engineering by Mason, Smith, Hund
- (2) Traffic Planning & Engineering by F.D. Hobbs
- (3) Traffic Engineering Practice
- (4) Traffic Engineering by F.D. Hobbs, B.D. Richardson
- (5) Traffic Engineering Handbook - ITE
- (6) Traffic Engineering Theory & Practice by Louis J Pignataro
- (7) Fundamentals of Traffic Engineering – ITTE
- (8) TPDM Vol. 4 - Traffic Signals
- (9) TPDM Vol. 3 - Traffic Signs & Road Markings
- (10) TPDM Vol. 7 – Parking
- (11) TPDM Vol. 8 – Survey
- (12) TPDM Vol. 9 - Public Transport

2.2 Introduction

2.2.1 Justification for its Application

2.2.1.1 One-way street systems are those in which vehicle movement on any carriageway within the system is limited to one direction. They are generally considered to be one of the simplest tools for relieving traffic congestion, improving road safety at junctions and improving progressive systems of traffic signal control without expensive capital outlay and excessive policing. Their most effective usage is in the congested central area of cities with a grid patterned road network. It is one of the traffic management techniques to optimise the use of available road space when major road construction is not possible.

2.2.1.2 Benefits to be expected from making a street one-way are described in section 2.3.1. Despite the advantages, possible adverse effects may be brought about by making a street one-way. The disadvantages are set out in section 2.3.2. Before instituting a one-way street system, all advantages and disadvantages should be carefully weighed.

2.2.2 One-way Street System Design

2.2.2.1 The necessary data collection for assessment of one-way street systems is mentioned in section 2.4.1. However not all information required for full assessment will always be readily available and it will need to be assessed whether the scheme justifies the time and expense of collecting all such information or whether using the information that is easily obtained would be satisfactory.

2.2.2.2 A feasibility study and a cost/benefit analysis can be carried out in accordance with the outlines given in sections 2.4.1 and 2.4.3. A general description of other planning considerations such as traffic assignments, liaison and consultation with relevant parties, publicity etc. can be found in Chapter 1 of this volume.

2.2.2.3 The necessary signing and marking arrangements are given in section 2.4.4. The use of several one-way streets to form a clockwise or anticlockwise flowing system is described in section 2.5 to conclude this Chapter.

2.3 Advantages and Disadvantages of One-way Street Systems

2.3.1 Advantages

2.3.1.1 The primary reason for making streets one-way is to improve traffic movement. Although one-way operation is normally also accompanied by a reduction in accidents, safety is not normally the main reason for its introduction. The improvements brought about by the system are listed below.

2.3.1.2 Increased Capacity

The conversion from two-way to one-way operation can increase the capacity of a street. The extent is dependent on the local conditions such as distribution of traffic, turning movements, street widths etc. since all vehicles in a one-way street are moving in the same direction, there is no "friction" resulting from vehicles travelling in the opposite direction. Stationary vehicles including those at stops are generally less troublesome as the whole width of the road is available for one direction of travel. At a road junction, conflicting points can be reduced by a one-way street system. This is illustrated in Diagram 2.3.1.1. Should a junction be controlled by traffic light signals, turning a street from two-way to one-way can simplify the method of control and improve the reserved capacity of the signalized junction. Significant benefits can be obtained at complex junctions from the introduction of one-way streets on some or all approaching roads.

2.3.1.3 Increased Speed and Reduce Traffic Delay

The removal of opposing vehicles allows a more even traffic flow to be obtained and hence higher operating speeds and more regular journey times. The latter is of particular benefit to public transport operations.

2.3.1.4 Increased Safety in Reduction in Number of Accidents

The introduction of a one-way street scheme generally results in a reduction in the number of accidents. Head-on accidents are eliminated. There will be a fewer pedestrian/vehicle and vehicle/vehicle conflicts at junctions. Accidents due to poor road lighting should be reduced since there will be no headlight glare problem. Having said the above it must be noted that there is no data in the Territory to quantitatively verify improvements in road safety at junctions as described above. Moreover, increased severity in the number of pedestrian accidents between junctions may result. These are described in para. 2.3.2.6 below.

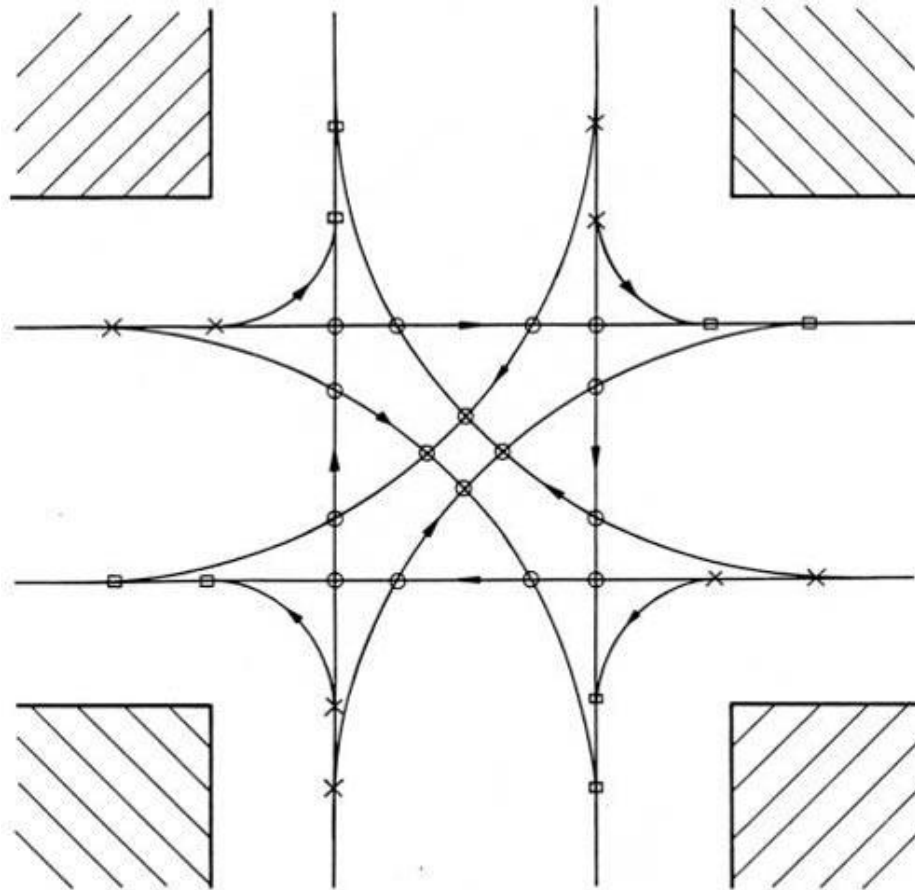
DIAGRAM 2.3.1.1: CONFLICT POINTS AT INTERSECTION**KEY :**

○	CROSSING POINT
×	DIVERGING POINT
□	MERGING POINT

2.3.1.5 **Improved Utilization of Streets**

On carriageways with odd number of lanes, two-way working cannot make the full use of them for flowing traffic. One-way systems allow carriageways with an odd number of lanes to be utilised more efficiently than the same carriageway operating as a two-way road.

2.3.1.6 **Improved Signal Progression**

On one-way streets controlled by traffic light signals, the signals can easily be linked to provide a satisfactory vehicle progression speed without the need to consider vehicles in the opposite direction. Moreover, signal controlled pedestrian crossings can be provided at any convenient point other than junctions (except run-ins, bus-bays etc.) without interfering with vehicle progression.

2.3.1.7 **Increased Parking and Loading/Unloading Facilities**

Very often two-way streets are not wide enough to provide on-street parking or loading/unloading facilities because of heavy volume of traffic. By converting such streets to one-way operation, there can be opportunity to provide parking or loading/unloading facilities on at least one side of the street. Nevertheless, it is generally considered inappropriate to allow on-street parking on major roads as parking manoeuvres have an adverse effect on traffic flow and road safety.

2.3.1.8 Increased Space for Pedestrians

The introduction of a one-way street may result in reduction in total number of traffic lanes and hence space would be available for footpath widening and enhancement of streetscape. Straight crossings instead of staggered crossings could be provided for pedestrians so that pedestrians are able to cross the carriageway at one go.

2.3.2 **Disadvantages**

2.3.2.1 Before the introduction of a one-way street system the engineer should be satisfied that the advantages associated with the scheme as described above outweigh the possible disadvantages as described below. In order to assist the designers, some suggestions on avoiding or alleviating such drawbacks are also given.

2.3.2.2 The District Council Committees should be consulted on major traffic management schemes . Disadvantages associated with one-way system may be used as basis for objecting to such schemes. It is necessary for the designer to be well aware of these aspects not only to ensure that on-balance, the community benefits from the scheme, but also to enable him to promote it rather than defend it.

2.3.2.3 Increased Travel Distance

With the implementation of a one-way system, motorists often cannot head directly to their destination or they will have to leave the area through a longer route. The designer should take it into consideration and ensure the effect should be offset by a reduction in journey time as a result of less congestion and a higher journey speed. Walking distance for bus passengers will also need to be taken into account if the buses are routed to the adjacent street.

2.3.2.4 Loss of Amenity

In most cases, the implementation of a one-way system involves the use of some originally less trafficked streets. Increased traffic flow on these streets may be expected to raise the traffic noise level, create difficulties for pedestrians crossing the street, and give rise to other environmental problems. Improved accessibility by the provision of better public transport facilities, signal controlled pedestrian crossing places etc. in association with the scheme are improvements to amenity and should be considered together with overall benefits to be obtained.

2.3.2.5 Loss of Business

The effect on business of introducing a one-way traffic scheme on a road differs depending on many factors. On some minor roads, more traffic will be brought onto them as a result of the one-way scheme thus bringing in more potential customers when previous driving habits are overcome. On the other hand, when one-way systems are implemented to form major gyratory schemes in which severe stopping restrictions are imposed and there are limited (though adequate) provisions for pedestrian crossing facilities, business may be adversely affected due to inconvenience.

2.3.2.6 Increase Severity of Accidents

One-way operation may result in an increase in the number of non-head-on collision type of accidents, and in severity of the type of accidents due to higher travelling speeds. The number of mid-block pedestrian accidents may also increase especially when there are central refuges on a wide road. Pedestrians standing in the central refuge may look in the wrong direction for traffic. Therefore it is recommended that these mid-block refuge islands should be removed when changing a two-way road into one-way. Where splitter islands are provided at junctions the carriageway should be marked with road marking 1135 or 1136 appropriate, "Look Right", "Look Left" respectively, to ensure that pedestrians do look in the correct direction. Reference may be made to T.P.D.M. Volume 3 on Traffic Signs and Road Markings. Should vehicle speeds along a one-way street become excessive, signals can be installed at strategic locations assisting pedestrians in crossing the street and at the same time vehicle progression can be adjusted by varying the off-sets between signals lights.

2.3.2.7 Confusion to Motorists

The one-way system should be as simple as possible to alleviate possible confusion to motorists. At the terminal points of a one-way street where two-way working turns into one-way working and vice versa, motorists need to select lanes. Proper signing with adequate visibility should be provided to reduce the requirement for sudden lane changing. Adequate publicity may also reduce the number of "unfamiliar" drivers affecting the efficiency and safety of the scheme.

2.4 Design of One-way Street Systems

2.4.1 Information Required

2.4.1.1 In order to carry out a feasibility study of a one-way street system scheme, a lot of information has to be collected. Dependent on the scheme, certain information is considered important and others less important or even irrelevant. A reasonable judgement has to be made. The data so collected can then be studied. There are brief outlines contained in Chapter 1 of this volume on the traffic distribution and assignment. With reference to the signal calculation, the reader may refer to Vol. 4 of the TPDM.

2.4.1.2 The following information is relevant to feasibility studies of one-way street systems :-

- (i) Widths, other geometrical and environmental factors such as gradient, horizontal alignment etc.
- (ii) Public transport operation routeings, stops and stands of bus, GMB, PLB and taxi services)
- (iii) Traffic control devices (signs, signals)
- (iv) Origins – Destinations of traffic
- (v) Flow on each link of the system
- (vi) Journey distance and journey speeds
- (vii) Local major traffic generators
- (viii) Loading and parking activities and provisions in the study area
- (ix) Major pedestrian routes and desire lines together with pedestrian flows at critical locations.

2.4.2 Major Considerations

2.4.2.1 In the preliminary planning of one-way street systems, there are certain major items to be taken into consideration. They are itemised in the following paragraphs.

2.4.2.2 Complementary Streets

The prerequisite to a one-way scheme is the availability of complementary streets to accommodate the displaced traffic. Grid iron street layouts are ideal. Nevertheless the complementary street should be of a width comparable to the main street. Otherwise it may result in an unbalanced, inefficient flow of traffic. This is because traffic flow on the complementary street will increase. If a gyratory system is formed, the gyratory should not be excessively large. The two streets should not be too far apart (approx. guide not more than 180m).

2.4.2.3 Terminal Point

The ends of a one-way system are critical areas which need careful design. A lot of lane changing, crossing and turning movements have to take place here. Proper signing and marking is important for the satisfactory implementation of a one-way system, and full use should be made of channelling islands. An ideal situation is shown on Diagram 2.4.2.1 in which each complementary pair converges to form a Y intersection. Care should be taken with respect to lane balance to ensure that the number of lanes at the entry point is not greater than that at the exit point. In some cases, a properly designed transition length may be necessary. If the system ends on cross-streets then the junction at the terminal points will be required to carry a considerable burden of traffic with many turning movements. As a result, it is often necessary to extend a one-way system beyond the area concerned so that the extra turning traffic thrown can be spread out among two or more cross-road junctions.

2.4.2.4 Detour and Environmental Impact

It has been pointed out in section 2.3.2 above that the imposition of a one-way system is normally associated with detour, and environmental deterioration. Therefore in formulating such a scheme, care should be taken to objectively assess the amount of traffic that would be disadvantaged, the amount of additional traffic injected into the complementary streets etc. so that the costs can be compared with the benefits.

DIAGRAM 2.4.2.1: TERMINAL POINTS OF ONE-WAY STREET SYSTEM

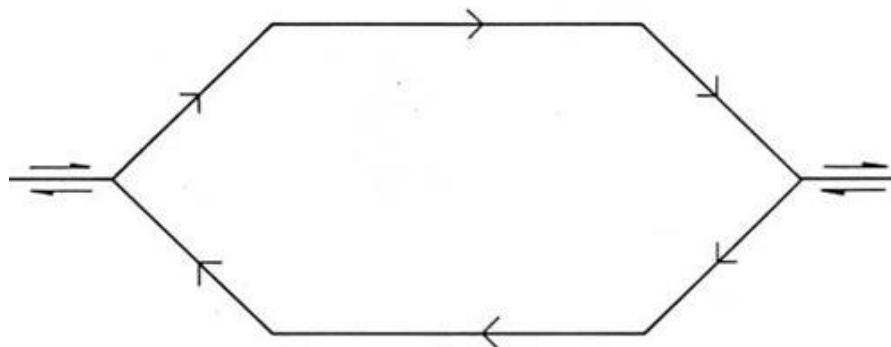

2.4.2.5 Impact of Public Transport

- (i) Anything which changes the street traffic plan of a city may affect public transport routeings. It is important that such changes should not adversely affect transit operations. Passenger walking distance exceeding 200m should be avoided. When a pair of one-way streets is installed, some public transport passengers may have to walk an extra block whilst the walking distance for others may be reduced. Careful planning with the public transport operators should result in a minimum of extra walking for these passengers. The effect of a one-way system on tracked vehicles such as trams is much more serious. Expensive track and electrical distribution changes may be required.
- (ii) In general bus operators and planners may not like one-way streets because of the increased mileage that can result; difficulties for non-regular passengers in finding bus stops for 'return' journeys and the introduction of additional bends in bus routes, which cause difficulty to passengers when moving between the bus doors and their seats after boarding, and vice versa prior to alighting. Moreover, patronage may be affected because passenger could not board and alight in the same street. Higher journey speed and adherence to schedule may be benefits for bus operators to accept one-way schemes.
- (iii) Sometimes the introduction of a contra-flow bus lane may overcome the problems mentioned above. However, this has to be justified by adequate bus flow and patronage. Contra-flow bus lanes with low bus volume would create an unbalanced flow situation in the two opposite directions and could be hazardous.

2.4.2.6

Impact of Pedestrians

- (i) As mentioned above, the provision of better pedestrian facilities would usually be easier when streets are one-way working. Signal controlled pedestrian crossings can be provided in the form of a protected crossing as shown in Diagram 2.4.2.2. The same can be installed at any location between junctions to suit the pedestrian demand without affecting progression for vehicular flow. Footpaths may also be widened in some cases for one-way operation of a street.

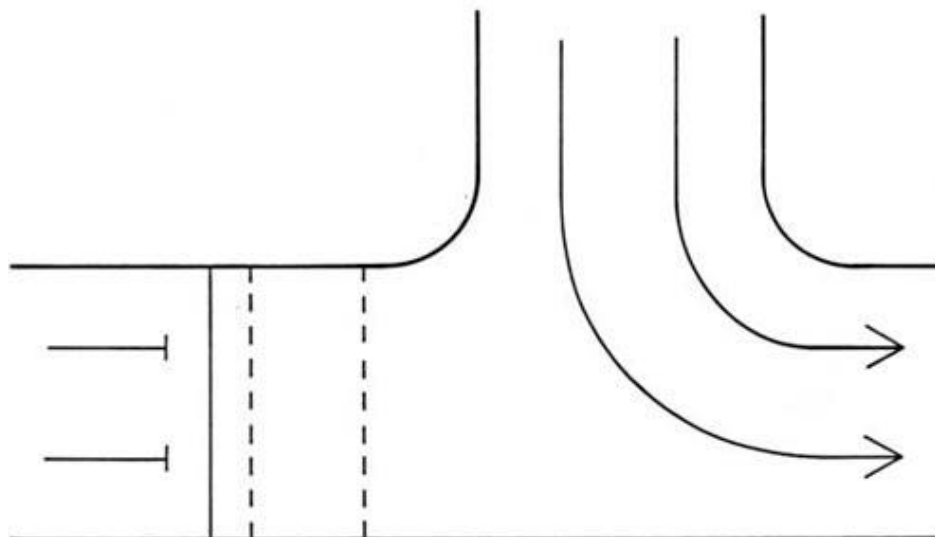
DIAGRAM 2.4.2.2: PEDESTRIAN FACILITIES AT ONE-WAY STREET JUNCTION

- (ii) On the other hand, pedestrians may find it more difficult to obtain public transport services because stops for the same route in different directions are located on different streets. As vehicle speeds on a one-way street are higher, better pedestrian channelisation will be required to guide pedestrians to cross at suitable locations with adequate sight lines for on-coming vehicles. The provision of central refuge islands is not recommended in view of the fact the pedestrians may look in the wrong direction for vehicles.
- (iii) The designer should be alert of the feasibility of vehicles stopping on the wrong side of the one-way street for passenger boarding/alighting activities. This is potentially dangerous and would cause disruption to the passing traffic. Adequate attention should be given to this effect particularly if the street is a popular route for school buses or where a school is located on the off-side of the one-way street.
- (iv) To alleviate the above problem, apart from more careful design from the engineering point of view, publicity is important to ensure that pedestrians are aware of such changes.

2.4.2.7

Safety

Road safety conditions on a road operating one-way or two-way are different. Whilst certain types of accident may be reduced by turning a street into one-way, other types of accident may be increased. This also applies to severity. Therefore if accident reduction is to be given as a justification for a one-way street system, a detailed investigation of the accidents likely to be reduced and an assessment of other accidents that may occur because of the change will be necessary.

2.4.2.8

Stopping Restriction

On major one-way streets and gyratory systems, stopping restriction may need to be applied. Alternatives for servicing fronting development may have to be made.

2.4.2.9 Parking Provision

On-street parking spaces should normally only be provided on minor streets of a major system. Volume 7 should be referred to for specific details on the requirement.

2.4.3 **Feasibility Study**

2.4.3.1 From data collected as mentioned in paragraph 2.4.1.2 above the following feasibility studies can be carried out for cost/benefit consideration :-

- (i) Traffic volume studies to estimate the flows and turning movements
- (ii) Speed and delay studies in both peak and off peak periods
- (iii) Traffic signal studies (Ref. TPDM Vol. 4)
- (iv) Loading/parking studies (Ref. TPDM Vol. 7)
- (v) Capacity analysis (Ref. TPDM Vol. 2 & 4)
- (vi) Estimation of added travel distance in network
- (vii) Public transport routeing and stops
- (viii) Movement of emergency vehicles
- (ix) Possible effect on business
- (x) Accident (type, frequency, severity)
- (xi) Pedestrian movement
- (xii) Cost of implementation, operation and maintenance.

2.4.3.2 As the above are generally applicable to most traffic management measures, detailed descriptions of the feasibility study techniques are not given here. Reference should be made to other chapters in this volume and also Volume 8 of the TPDM.

2.4.4 **Signing and Marking**

2.4.4.1 In most cases, the major costs of one-way system lie in the provision of traffic signs and markings. They are important not only to prevent entry in the wrong direction, but also to advise motorists of banned turns or mandatory movements. Direction or gantry signs may also be required to offer advance information to motorists of destination and lane selection to avoid possible confusion as mentioned in paragraph 2.3.2.7 above. Readers are advised to refer to TPDM Vol. 3 for the necessary signs and markings.

2.4.4.2 Normally a one-way street is signed at the entry point with a pair of "one-way" traffic signs and at the exit point with a pair of "No entry" signs. It is essential to sign all points where motorists may have to make a decision. Advance informatory signs erected at suitable locations with adequate visibility help to reduce the requirement for sudden lane changing. "Two-way" traffic signs should be placed where the one-way street ends and "No left/right turn" signs should also be displayed at suitable locations.

2.4.4.3 When converting a street from two-way into one-way, there may be requests from private developers for the erection of "Turn left" or "Turn right" signs outside their vehicular entrance/exit. Whilst each case should be considered on its own merit it is suggested that provision of these signs should be avoided as far as possible. For premises with a combined entrance/exit arrangement, drivers entering from the one-way street should realise that when leaving the premises they are entering a one-way street. This should also apply to premises with entrance into and exit onto the same street as shown in Diagram 2.4.4.1. Separate entrance/exit arrangement as shown in Diagram 2.4.4.2 may warrant the consideration of providing such signs at the exit. Nevertheless, it may be worth considering recommending the private developer to provide his own indications of the one-way street within the development.

2.4.4.4 Pedestrians

It is mentioned in paragraph 2.3.2.6 that a potential hazard to pedestrians on central refuge islands is they may look in the wrong direction for traffic. It would be preferable to avoid the provision of central refuge islands. Should this be inevitable, consideration should be given to providing carriageway markings to indicate to pedestrians the direction of traffic. TPDM Vol. 3 refers.

2.4.4.5 Parking/Stopping Restrictions

Depending on the need, parking spaces may be provided or stopping restrictions may be imposed. These require the use of appropriate signs and markings.

DIAGRAM 2.4.4.1: EXIT TO AND ENTRANCE FROM ONE-WAY STREET

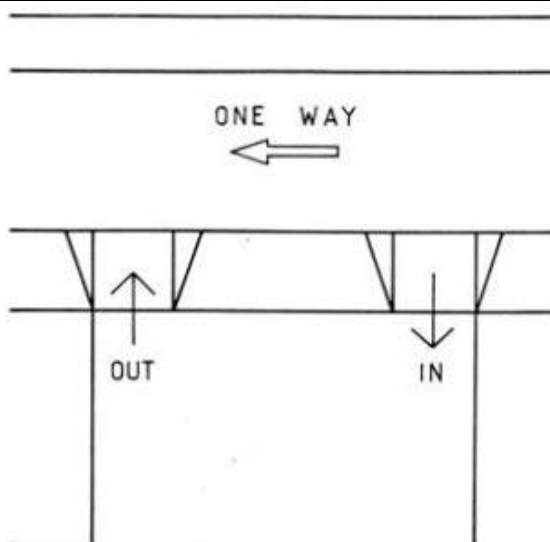
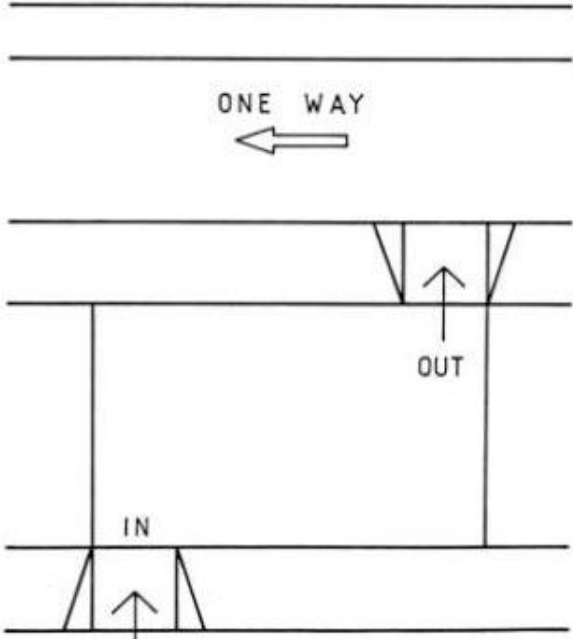

DIAGRAM 2.4.4.2: EXIT ONLY ONTO ONE-WAY STREET



2.5 Gyratory System and Associated Transport Management Techniques

2.5.1 Advantages of a Gyratory System

2.5.1.1 Very often two one-way street pairs crossing each other are employed to form a gyratory system in which vehicles travel in either a clockwise or an anticlockwise direction. This is often used to alleviate traffic circulation problems in the urban area.

2.5.1.2 In a gyratory system, the number of conflicting points at a junction is reduced. This can be easily seen by comparing Diagram 2.3.1.1 and 2.5.1.1.

DIAGRAM 2.5.1.1: CONFLICT POINTS AT A JUNCTION IN A GYRATORY SYSTEM

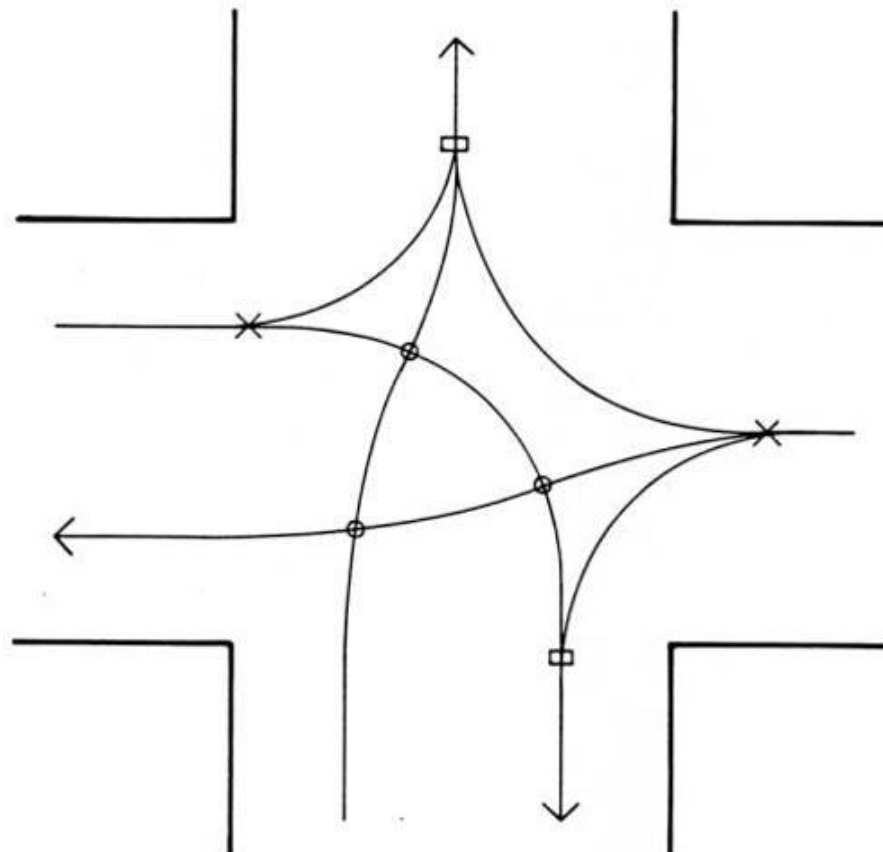

KEY :

○	CROSSING POINT
×	DIVERGING POINT
□	MERGING POINT

2.5.2 Clockwise and Anti-clockwise Gyratory Systems

2.5.2.1 Given the driving practice in Hong Kong, a clockwise gyratory system is generally preferred to an anticlockwise gyratory system. This can be illustrated in a simple form taking into consideration a two-lane network as shown in Diagram 2.5.1.2.

- 2.5.2.2 Having mentioned the advantage of a clockwise gyratory system, it is worth mentioning that the employment of a clockwise or an anticlockwise gyratory system depends on many factors, such as the geometry of the street network, existing traffic management schemes in the vicinity etc. Where gyratories overlap an alternate clockwise and anticlockwise systems must be employed.
- 2.5.2.3 In case a gyratory system encloses a major trip generation block, it would be advantageous to impose an anticlockwise system so that public transport passengers would have easier access to public transport stops and the requirement for crossing movements would be minimised.

DIAGRAM 2.5.1.2
CLOCKWISE GYRATORY

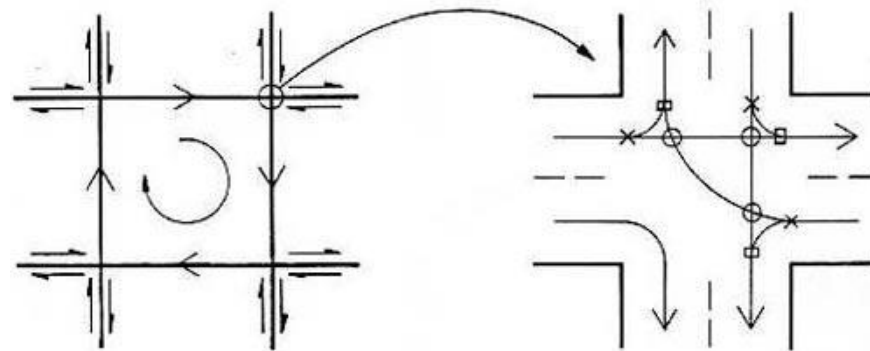

ANTICLOCKWISE GYRATORY

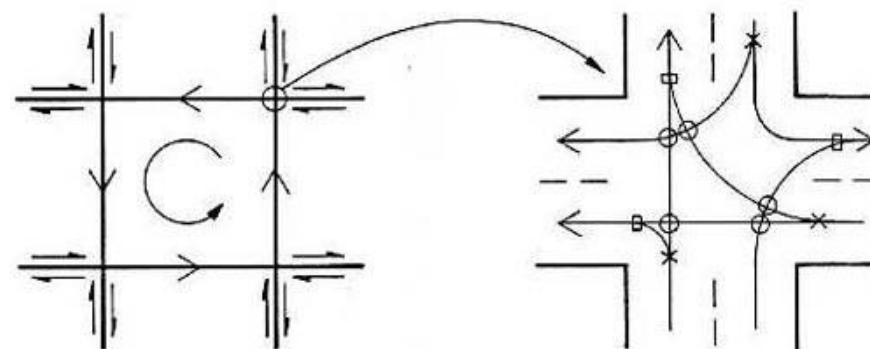

KEY :

O CROSSING POINT

X DIVERGING POINT

[] MERGING POINT

2.5.3 Associated Management Techniques

- 2.5.3.1 In order to maximise throughput, it may be necessary to ban certain turning movements and to reposition them at other locations. Banning of right turning movements is frequently employed. Mainly, there are three methods of effecting a ban on a particular right turn, viz a P-turn, G-turn, and a Q-turn. They are illustrated in Diagram 2.5.3.1.
- 2.5.3.2 In a clockwise gyratory system, some right turning movements may need to be replaced by G-turns. In the case of an anticlockwise gyratory system, the number of conflicting points can be reduced by banning some right turning movements and introducing a Q-turn. An example is illustrated in Diagram 2.5.3.2.

DIAGRAM 2.5.3.1

P-TURN

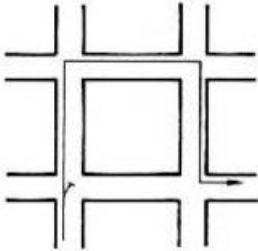

G-TURN

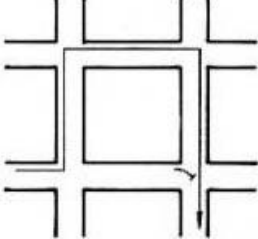

Q-TURN

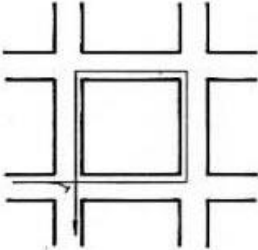
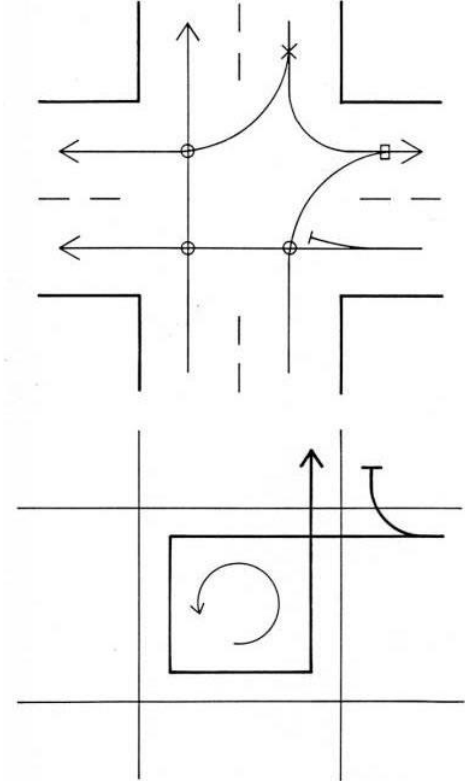

DIAGRAM 2.5.3.2

Q-TURN FOR ANTICLOCKWISE GYRATORY



2.5.4.1 Public Transport Priority

In the case of a large gyratory system, bus routeings may experience a long detour. In these circumstances, priority for buses in the form of a contra-flow bus lane should be considered. The benefits to the public transport passengers should however be compared to the costs of sorting out the increased conflicts at the two ends of the bus lane as well as the increase in accident potential should the bus flow be much lighter than the general traffic flow in the opposite direction.

2.5.4.2 Pedestrian Crossing

The provision of signal controlled at-grade pedestrian crossing facilities in a gyratory system may sometimes present a very tricky problem to the planner. This is especially true when the size of the gyratory system is small. Therefore the provision of grade-separated pedestrian crossing facilities should be considered for long term schemes.

2.5.4.3 Stopping Restriction

Stopping restrictions should normally be imposed on the whole gyratory system. The time period for such restrictions should carefully be considered as too stringent restriction would result in the requirement for loading/unloading facilities be provided in the vicinity.

TPDM Volume 6 Chapter 3 – Bus Priority

3.1 References

- 1 ROAD TRAFFIC (TRAFFIC CONTROL) REGULATIONS, Cap 374.
- 2 DEPARTMENT OF TRANSPORT. “Implementation of Bus Priorities”. Technical Memorandum H6/76, Department of Transport, London, 1976.
- 3 DEPARTMENT OF THE ENVIRONMENT. “Bus Priority – Proceedings of a Symposium held at TRRL, 1972”. TRRL Report LR 570, Transport and Road Research Laboratory, 1973.
- 4 DEPARTMENT OF THE ENVIRONMENT. “Bus Priority in a Network of Fixed Time Signals”. TRRL Report LR 666, Transport and Road Research Laboratory, 1975.
- 5 PLANNING AND TRANSPORT RESEARCH AND COMPUTATION. “Bus Priority Schemes”. PTRC Summer Annual Meeting, June 1977. PTRC Education and Research Services Ltd., London.
- 6 NATO (COMMITTEE ON CHALLENGES OF MODERN SOCIETY). “Bus Priority Systems”. CCMS Report No. 45, Transport and Road Research Laboratory, 1976.
- 7 OECD. “Bus Lanes and Busway Systems”. OECD Road Research Group, 1976.
- 8 INSTITUTION OF HIGHWAYS AND TRANSPORTATION. “Roads and Traffic in Urban Areas”. Institution of Highways and Transportation with the Department of Transport, 1987.
- 9 DEPARTMENT OF TRANSPORT. “Evaluation of Bus Lanes”. Contractor Report 87 by the Transport Research Group, Department of Civil Engineering, University of Southampton. Transport and Road Research Laboratory, 1988.
- 10 DEPARTMENT OF TRANSPORT. “Bus priority by selective detection”. Contractor Report 88 by the Transport Research Group, Department of Civil Engineering, University of Southampton. Transport and Road Research Laboratory, 1988.
- 11 THOMSON. J.M. “Guide to Economic Evaluation of Transport Projects”. Halcrow International Partnership for Highways Office, P.W.D. Hong Kong and Asian Development Bank, 1982.
- 12 TRANSPORT DEPARTMENT, HKSAR & ATKINS CHINA LTD. “Final Report – Feasibility Study of Inter-district Bus-only Lanes, 1999”
- 13 RYANWJL. Price Theory. London, 1965 (Mc Millan and Co.)
- 14 OSUNA EE and GF NEWELL. Control Strategies for an Idealized Public Transport System. Transportation Science 1972, 6(1) p.52
- 15 ARTHUR ANDERSEN & CO. Bus Route Costing for Planning Purposes. DOE, TRRL SR 108 UC. Crowthorne, 1975
- 16 CHARTERED INSTITUTE F PUBLIC FINANCE AND ACCOUNTANCY. Passenger Transport Operations, 1974 (CIPFA, London)
- 17 OLDFIELD RH Elasticities of Demand for Travel. DOE, TRRL SR 116 UC. Crowthorne, 1974
- 18 DAWSON RF and WAS P. Vehicle Operating Costs in 1973. DOE, TRRL Report LR 439, Crowthorne, 1972

- 19 DEPARTMENT OF THE ENVIRONMENT. Road Accidents in Great Britain 1973. London 1974 (Her Majesty's Stationery Office)
- 20 MINISTRY OF TRANSPORT. Road Track Cost. London, 1968 (Her Majesty's Stationery Service)
- 21 REES R. The Economics of Investment Analysis. Civil Service College Occasional Paper 17. London, 1973 (Her Majesty's Stationery Office)
- 22 MISHAN EJ. Cost Benefit Analysis, London 1971 (George Allen and Unwin)

3.2 Introduction

- 3.2.1 In the past few decades traffic management techniques have been applied fairly extensively in many urban areas around the globe in an attempt to make better use of the available roadspace.
- 3.2.2 Initially, these were aimed at maximizing vehicle flows through the road network, but more recently greater emphasis has been placed on the need to include in such schemes some measure of priority to buses because of their higher people-moving capacity.
- 3.2.3 Measures that improve the flow of all traffic, including buses, may give great benefits to bus services, but are not necessarily classified as bus priority measures. They would include a restriction of on-street parking and/or stopping, improved road marking, junction modification, retiming traffic signals, and even the relocation of bus stops.
- 3.2.4 Bus priority measures are those that help attain higher travel speeds and improved regularity of bus operations, in order to provide a more attractive service to passengers relative to other forms of road transport.
- 3.2.5 It is important to appreciate that bus priority measures should not be used as a “all-purpose solution”, whenever buses are subject to delays. The cause of delay should first be identified and possible traffic management and/or bus priority solutions should thereafter be investigated.
- 3.2.6 This Chapter attempts to provide guidance on the types of bus priority measures that exist and circumstances in which they could be implemented with overall beneficial results to the community. It also emphasises the need for evaluating and monitoring the performance of such measures.

3.3 Use of Bus Priority

3.3.1 Warrants

3.3.1.1 The implementation of bus priority measures may be warranted when, despite other traffic management measures, one or more of the following conditions exist :-

- (i) repeated occurrence of bus delay on certain sections of road due to queuing vehicles;
- (ii) a reasonable number of buses per hour using section of road;
- (iii) the advantages for bus passengers are likely to outweigh the disadvantages to other motorists;
- (iv) the desirability to operate buses in two directions in one-way streets;
- (v) a need for buses to penetrate areas of passenger demand without undue detour.

3.3.1.2 A “reasonable” number of buses is difficult to define quantitatively as there are several factors involved, some site related. It is in every case necessary to compare the overall advantages for bus passengers and bus operations with the disadvantages for non-priority road users. Experience indicated that designation of a bus-only lane will be difficult to justify unless there are over 60 buses or 3000 passengers per hour at that particular road section. Also, sufficiency of the remaining traffic lanes for the non-priority road users and impact on railway are other major considerations.

3.3.1.3 A bus priority for a few buses can be justified if there are only minor disadvantages for non-priority road users but a considerable advantage for bus passengers. On the other hand it can be imprudent to introduce a bus priority measure even with a high volume of buses, if considerable disadvantages for non-priority traffic are combined with very limited advantages for buses.

3.3.1.4 To be successful, a bus priority measure should be understood and respected by other road users. This could be achieved by prior publicity and consultation with those likely to be affected, and only if the measure is seen to be reasonable and well utilized by priority vehicles.

3.3.2 Objectives

3.3.2.1 Buses normally carry more people than other vehicles in relation to their use of roadspace. In fact, the Second Comprehensive Transport Study (CTS-2) estimates that in 1996 buses would have an efficiency index of 13.4 as compared with 1.2 for taxis, 1.9 for private cars and 5.5 for minibuses. The efficiency index is based on the ratio of estimated passenger-kilometers to pcu-kilometres.

3.3.2.2 The efficiency of a road based transport system could therefore be improved by giving buses priority over other vehicles, provided the method of assigning priority does not penalize other vehicles to any great extent.

3.3.2.3 However, the objective for bus priority is not always as specific as “maximising the overall economic efficiency of a transport system”. Other limited objectives are often set, the most common being the improvement of bus services.

- 3.3.2.4 Bus priority schemes can provide shorter running times and distance, lower and more predictable waiting times (due to increased reliability of the service) and reduced walking distances (due to the siting of bus routes and bus stops more suited to passengers' needs).
- 3.3.2.5 Another objective frequently quoted is the improvement of the image of public transport. This would be a real benefit only if it leads to more people using buses, particularly if they were previously private car or taxi users.
- 3.3.2.6 Although a bus priority scheme can lead to reduction of the operating costs of services affected, it should not be classified an objective of providing priority. In fact, the reduction in operating costs is usually converted into service improvements in the form of higher frequencies. It is treated as a benefit during the evaluation process.

¹Similar Efficiency Index is not provided in CTS-3

3.3.3 Effects of Bus Priority Schemes

3.3.3.1 Whatever the objectives of bus priority may be, such schemes will affect large numbers of people in a variety of ways. These effects can be classified under three main categories as shown below:-

(i) Social and Political

- (a) redistribution of costs and benefits between different sections of the community e.g. car owners and non-car owners, higher and lower income groups;
- (b) changes in the flow of different classes of vehicles e.g. cars, taxis, buses minibuses and goods vehicles;
- (c) changes in the numbers and types of pedestrian journeys within specific areas e.g. bus only streets;
- (d) changes in attitudes towards bus priority measures resulting from a particular scheme or schemes;
- (e) changes in the integration/severance of land use.

(ii) Environmental

- (a) changes in air pollution;
- (b) changes in noise levels;
- (c) changes in the visual scene;
- (d) changes in vibration.

3.4 Types of Bus Priority

3.4.1 Bus priority measures are classified into the following types :-

- (i) Bus lanes;
 - (a) with-flow;
 - (b) contra-flow.
- (ii) Bus-only streets;
- (iii) Bus gates;
- (iv) Bus-only turning movements;
- (v) Bus priority at junctions;
- (vi) Busways.
- (vii) “Give way to bus” scheme.

3.5 With-flow Bus Lane

3.5.1 Definition

3.5.1.1 According to the Road Traffic (Traffic Control) Regulations, Cap 374 the interpretation of a bus lane is as follows :-

“'bus lane' means a traffic lane of the type bounded by a road marking of the type shown in Figure No. 504 or 518 in the Schedule 2 and marked at its commencement by a road marking of the type shown in Figure No. 510 in the Schedule 2.”

3.5.1.2 A with-flow bus lane is defined as a traffic lane reserved for the use of buses where they continue to operate in the same direction as the normal traffic flow.

3.5.1.3 The bus lane is normally adjacent to the nearside kerb.

3.5.1.4 A bus lane in the offside lane or in a specially designed centre lane is generally not recommended, as signing is difficult and the provision of bus stops is not practical nor desirable.

3.5.1.5 However, in certain circumstances where right turning buses are to be accorded priority to pass queuing left turning or straight ahead vehicles, the offside lane adjacent to the center lane or the central median may be designated a bus lane. The same would apply where straight ahead buses are to be accorded priority to pass queuing left turning vehicles.

3.5.2 Advantages and Disadvantages

3.5.2.1 With-flow bus lanes allow buses and other permitted users to by-pass other queuing vehicles, acting essentially as queue-jumping devices. They provide free running conditions for buses along their length.

3.5.2.2 Benefits accrue to bus passengers in terms of reduced travel time, reduced waiting time at bus stops and improved reliability in bus headways. A reduction in walking time may be possible by re-siting bus stops.

3.5.2.3 The operator could derive benefits through a reduction in operating costs and a possible increase in revenue if more passengers are attracted to the service following the priority implementation.

3.5.2.4 Non-priority vehicles may experience small benefits due to the avoidance of their being trapped behind a bus at a bus stop.

3.5.2.5 If the capacity of the downstream junction for non-priority traffic is not reduced, their journey times may not be affected. However, the increase in queue length which accompanies all with-flow bus lane schemes may :-

- (i) block minor road entries upstream, thus adversely affecting cross traffic not wishing to use the bus lane link;
- (ii) divert non-priority vehicles wishing to avoid the longer queue formation along the bus lane link.

3.5.2.6 The diverted traffic could cause extra delay to themselves and other vehicles using those diversion routes. The increase in traffic may be environmentally undesirable.

3.5.2.7 Where a bus lane causes a loss in capacity of the downstream junction, non-priority vehicles would suffer considerable disbenefit, particularly if the junction is operating at or near capacity.

- 3.5.2.8 The travel time for non-priority vehicles will increase and the effects to cross traffic will be magnified. If diversionary routes are available, non-priority vehicles wishing to avoid the congestion along the priority route will divert in larger numbers, inducing disbenefits to themselves and others. If diversionary routes are not available, the disbenefits could be even greater.
- 3.5.2.9 The above and other factors would need careful evaluation. In general, a bus priority scheme has a greater chance of success if traffic management measures are employed to increase overall traffic capacity, and this extra capacity is used to benefit buses. Bus priority measures which cause major disbenefit to non-priority traffic are unlikely to be successful.

3.5.3 Design Considerations

- 3.5.3.1 In designing a with-flow bus lane an attempt should be made to strike a balance between giving buses as much benefit as possible while minimizing any adverse effects on other road users, railway operators, or other stake holders, e.g. shop owners or residents along the bus-only lane.
- 3.5.3.2 Where there is a bottleneck (usually a signal-controlled inter-section) that causes traffic congestion and delays the movement of buses, the bus lane should function as a queue-jumping device, without measurably reducing the capacity of the bottleneck.
- 3.5.3.3 The effect of introducing a bus lane on a link whose downstream junction is signal controlled depends mainly on the reduction in junction capacity that may result. If signal timings remain unaltered, junction capacity is directly related to saturation flow.
- 3.5.3.4 Cyclists should, as far as possible, be discouraged from using bus lanes, for their own safety and to avoid impeding the flow of buses. Alternative routes should be provided for their use. However, where the provision of an alternative route is not practicable cyclists should be permitted to use a nearside bus lane as it would be more hazardous for them to travel in the outer lanes. Traffic signs should be erected at the entrance to the bus lane where cyclists are prohibited.

Setback

- 3.5.3.5 Where the bus lane extends to the stop line, one lane of saturation flow is lost to non-priority vehicles, with a consequent decrease in capacity and increased delay. However, where the bus lane is terminated short of the stop line and a 'setback' is provided, the saturation flow for non-priority traffic may remain unaltered depending on the length of setback.
- 3.5.3.6 If the setback is too short, junction capacity will be reduced and non-priority traffic will suffer a delay. Too long a setback will result in buses suffering an unnecessary delay.
- 3.5.3.7 The length of the setback is therefore important in determining the efficiency of a bus lane. The extent of usage of the setback, termed 'packing factor', is also important.
- 3.5.3.8 The optimum setback recommended in the UK Department of Transport Technical Memorandum H6/76 is twice the effective green time in metres i.e. 2g. More recent studies at the University of Southampton suggest an optimum setback distance around 2.7g.

- 3.5.3.9 The latter assumes a saturation flow of 1800 pcu/hr/lane, a vehicle spacing of 5.5m and is based on the following relationship:-
 Optimum setback (m) = $5.5 S_w g / 3600 n$
 where n = number of lanes at stop line
 g = effective green time (secs)
 S_w = maximum stop line saturation flow (pcu/hr)
- 3.5.3.10 The optimum setback indicated above assumes ideal conditions where maximum entry capacity can be achieved. In reality, factors such as poor exit alignment, exit constriction and poor signal timing could result in the setback not being fully utilized. The provision of a shorter setback may then be justified.
- 3.5.3.11 On-site observations should be conducted in determining the optimum setback desirable at each location where a bus lane is proposed. Irrespective of other considerations an adequate setback should be provided to facilitate non-priority left turning vehicles at road junctions where such turning movement is permitted.
- 3.5.3.12 Junction capacity may be lost due to the introduction of a bus lane through the failure of motorists not fully utilizing the nearside lane within the setback. The ratio of the actual queue in the nearside lane to that which could have formed within the setback is known as the 'packing factor'.
- 3.5.3.13 The packing factor could decrease as the setback length increases. It could be relatively low particularly where the nearside lane within the setback is restricted to use by left turning vehicles.
- 3.5.3.14 Provided the nearside lane within the setback is likely to be fully occupied, a flare at the approach to a junction would further increase capacity. The provision of a flare is fairly common at the approaches to a roundabout.
- Taper at entry
- 3.5.3.15 The start of a bus lane should be designed so as to avoid danger to non-priority vehicles attempting to merge into the lesser number of lanes in the area of the bus lane. The effect of the merge is more severe if the volume of traffic, particularly in the nearside lane, is high.
- 3.5.3.16 The angle of deflection of the lane at the entrance to the bus lane should normally not be greater than 1:10. However, because of site constraints a sharper deflection may often be necessary. A taper of 1:5 is generally acceptable in these circumstances.
- 3.5.3.17 The location of the merge point relative to the upstream junction is significant. If it is located close to the exit of the junction, the exit construction could reduce the junction capacity.
- 3.5.3.18 Also, insufficient room for the merging manoeuvre could discourage non-priority vehicles using the nearside lane, further restricting the effective capacity for such vehicles.
- Bus stops
- 3.5.3.19 As indicated in TPDM Volume 9, Chapter 2, the provision of bus stops within a nearside bus lane should be kept to a minimum in order to reduce potential delays to buses held up behind a stationary bus. Although a bus could move out of a bus lane and back into the lane for the purpose of overtaking a stationary bus at a bus stop, the movement is not desirable as it would impede the flow of non-priority vehicles in the adjacent lane particularly if there is a queue.

- 3.5.3.20 Should a bus stop be required, it should preferably be located at the end of the bus lane. The provision of a layby would allow buses using the bus lane to overtake a stationary bus at the bus stop.
- 3.5.3.21 Bus stops sited immediately downstream of the exit of a bus lane link could cause an exit construction, and consequent loss in junction capacity when a bus is stationary at the bus stop. Furthermore, the presence of a stationary bus would induce reluctance among motorists to use the nearside lane within the setback, causing an additional loss of junction capacity.
- 3.5.3.22 A bus stop sited within the setback would reduce junction capacity whenever a bus is stopped, and the approach is discharging. Motorists may tend to avoid using the nearside lane within the setback even when the bus stop is vacant. A loss of capacity would result.

Operational periods

- 3.5.3.23 The hours of operation of bus lanes can be varied to suit specific conditions at individual locations. In addition to considering the delay experienced by buses due to traffic congestion, other factors such as frontage access and servicing requirements, signing and enforcement problems and public reaction should be considered.
- 3.5.3.24 Bus lanes have their greater impact on journey times during peak periods when traffic intensity and bus occupancy are at their highest levels. However, at some locations the provision of bus lanes outside the peak periods may be desirable.
- 3.5.3.25 Wherever possible the time period should be standardized into the following categories to avoid confusing road users :-
- (i) peak hours – morning, evening, or both.
 - (ii) 7 am – 7 pm.
 - (iii) 7 am – midnight.

Other time periods to cater for particular situations can be considered. For example, to cater for the tidal flow of bus passengers, bus-lanes heading city centre should operate only in the morning peak whereas the opposite direction ones should operate only in the evening peak. Also, the impact of the bus-only lane on servicing/heavy goods vehicles should carefully be assessed and termination of the operating hours before 09:30 may be necessary at specific locations.

Lane Width

- 3.5.3.26 A minimum width of 3m should be provided for a bus lane. It should be measured from the kerb face to the centre of the white line demarcating the bus lane. At bends and corners the bus lane should preferably be widened where practicable to minimize possible intrusion of the swept path into the adjacent lane. The road should also be checked for excessive camber.
- 3.5.3.27 Where cyclists are permitted to use a bus lane, the minimum lane width should be 3.5m.
- 3.5.3.28 A test run should preferably be conducted to ensure no obstructions nor hazardous situations exist.
Signs and markings
- 3.5.3.29 Regulation 12 of the Road Traffic (Traffic Control) Regulations, Cap 374 enables the introduction of a bus lane through the installation of traffic signs and road markings as specified therein.

3.5.3.30 Guidance on the use of traffic signs or with-flow bus lanes is given in Sections 2.3.2.44 to 2.3.2.47, 2.3.2.50 and 2.4.2.37 to 2.4.2.39 of Volume 3, Chapter 2. The use of road markings is described in Section 5.9.2 of Chapter 5 in the same Volume. In addition, the following points are significant as illustrated in Diagram 3.5.1:-

- (i) A supplementary distance plate, T.S. 768 or similar, can be added to T.S. 470 to indicate the distance to the commencement of the bus lane;
- (ii) A supplementary time plate, T.S. 714 or similar, can be added to T.S. 470, and T.S. 123 or similar, to indicate the hours of operation of the bus lane;
- (iii) T.S. 475 or similar should be erected at side roads to warn motorists of the relative position of, and the direction of flow of the bus lane along the main road;
- (iv) A supplementary time plate, T.S. 714 or similar, may be added to T.S.475 or similar where necessary;
- (v) T.S. 129 should only be erected at the end of the bus lane, and never at intermediate junctions;
- (vi) A supplementary plate “Except for access”, T.S. 711 should not be used.

3.5.3.31 Direction Signs can be erected where necessary, to inform motorists of a bus lane ahead. These should be of the map type as shown in Volume 3, Chapter 3.

DIAGRAM 3.5.1: SIGNING OF WITH-FLOW BUS LANE
FOR DETAILS OF ROAD MARKINGS, SEE DIAGRAMS 5.9.2.1 TO 5.9.2.6 IN VOL.3

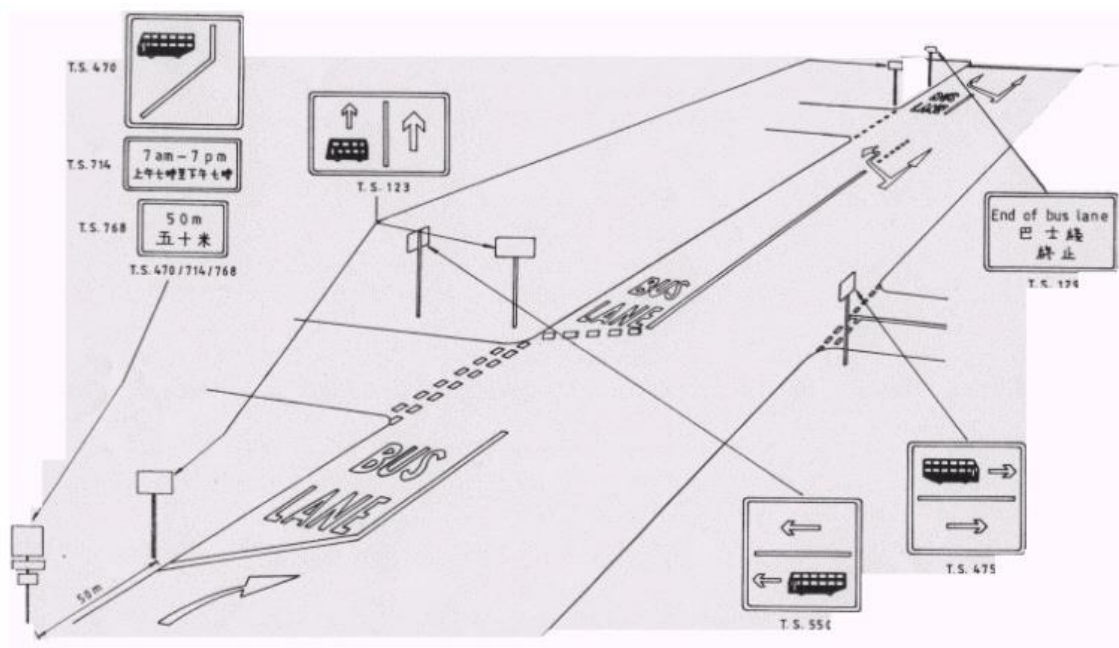

Locations other than signal controlled intersections

- 3.5.3.32 There could be locations other than the approaches to signal controlled intersections where bus priority measures may be required to prevent buses being unduly delayed due to traffic congestion. The effective use of a very short length of bus lane to enable buses to gain priority access towards the head of a queue of vehicles, could be seen at the southern approaches to the Cross Harbour Tunnel. Diagram 3.5.2 illustrates two such arrangements.
- 3.5.3.33 Northbound traffic using the Canal Road Flyover to access the tunnel is confined to a single lane slip road. The queue of vehicles along the slip road often tails back upto the Flyover and even into the Aberdeen Tunnel. The adjacent slip road that takes traffic to Gloucester Road eastbound is usually free flowing. A very short length of bus lane that links the two slip roads enables cross harbour tunnel buses to gain priority over other vehicles in the tunnel queue, by first using the free flowing slip road towards Gloucester Road and then diverting via the short length of bus lane into the tunnel queue.
- 3.5.3.34 In the second arrangement a very short bus lane connects Hung Hing Road to the Cross Harbour Tunnel entrance. Tunnel buses on Gloucester Road eastbound are thereby diverted via Fleming Road, Harbour Road and Hung Hing Road to the tunnel entrance avoiding the normal queue that usually extends beyond Tonnochy Road. Although the diversion is slightly longer than the direct route, it provides buses faster access to the tunnel.
- 3.5.3.35 The above arrangements illustrate the bus gate or queue-jumping concept of bus lanes that enable buses to gain priority over other vehicles without reducing the capacity of the link nor impeding the flow of non-priority vehicles. Experience indicated that this type of bus-only lane will be well received by the public and probably attract less complaint from the non-priority road users.

DIAGRAM 3.5.2: EFFECTIVE USE OF SHORT BUS LANES

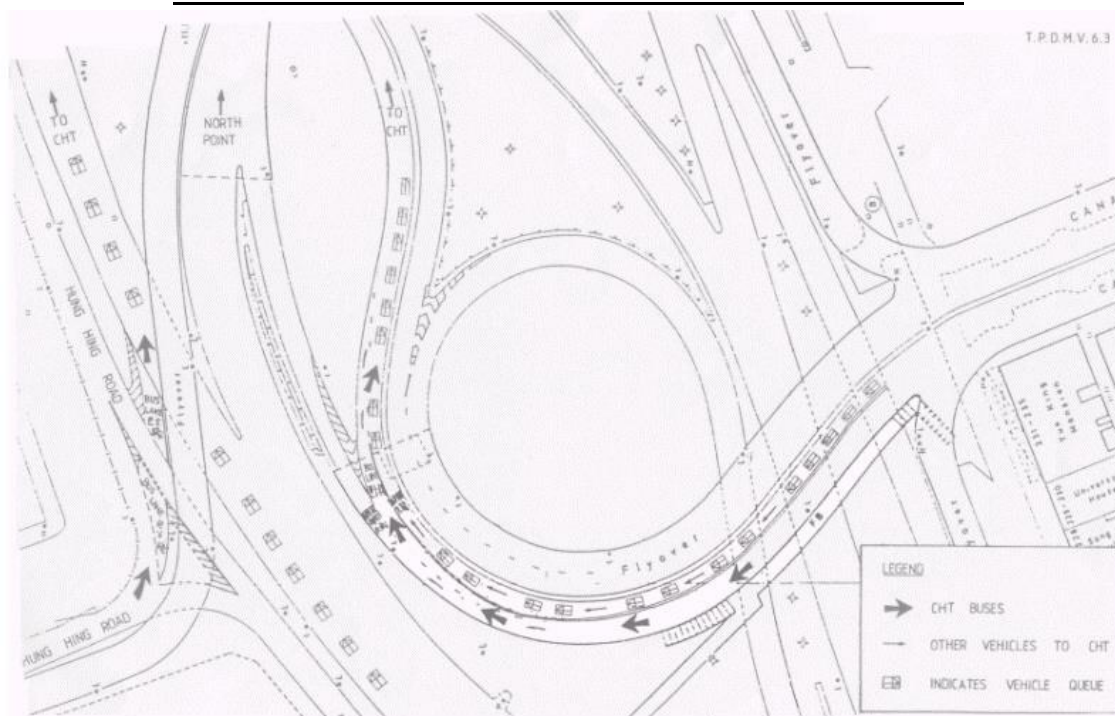

3.6 Contra-flow Bus Lane

3.6.1 Definition

- 3.6.1.1 A contra-flow bus lane is defined as a traffic lane reserved for buses travelling in the opposite direction to the normal flow of traffic.
- 3.6.1.2 Typically, a contra-flow bus lane is located in a one-way traffic system. The bus lane should always be the nearside lane as viewed from the bus.
- 3.6.1.3 An offside contra-flow bus lane is not recommended as the provision of bus stops can be extremely hazardous. Where for some reason an offside lane is a necessity, a “Bus only” street should be considered instead.

3.6.2 Advantages and Disadvantages

- 3.6.2.1 While with-flow bus lanes are generally most beneficial in that they allow buses to overtake queues of non-priority traffic, the main benefit of contra-flow lanes is in the avoidance of lengthy bus diversions that usually accompany one-way systems.
- 3.6.2.2 The introduction of one-way streets separates the outward and return routes of bus services using such streets. Such dissociation of routes is often inconvenient to bus passengers and can cause an appreciable loss in patronage.
- 3.6.2.3 The provision of contra-flow lanes eliminates the need for such separation. It retains the benefits of the bus routes which are well adapted to demand, and also the benefits derived from the one-way system.
- 3.6.2.4 When installed in a one-way circulatory system, a contra-flow bus lane can result in considerable savings in journey distance and time as well as bus passenger walking time.
- 3.6.2.5 Non-priority traffic could benefit from there being fewer buses and bus stops along the diversion routes.
- 3.6.2.6 Being predominantly a 24-hour facility, signing and enforcement requirements are usually less onerous. They are generally less confusing to the motorists and therefore better respected.
- 3.6.2.7 The junction layouts at one or both ends of the contra-flow lane are likely to require modification to minimize conflicts. These modifications could be expensive to install, and may even reduce capacity for non-priority traffic, so increasing delays.
- 3.6.2.8 The introduction of a contra-flow lane in a one-way street system may cause the reappearance of some of the conflicts that were eliminated when the one-way streets were introduced. More complicated signal control may be required with a resultant loss in capacity. Good signal progression would also be more difficult.
- 3.6.2.9 Accident hazard to pedestrians may be increased due to their unawareness that buses are running opposite to the normal one-way flow of traffic.
- 3.6.2.10 The servicing of premises fronting the street could be problematic.
- 3.6.2.11 The above and other factors would require careful evaluation.

3.6.3 Design Considerations

- 3.6.3.1 When designing a contra-flow bus lane every attempt should be made to fit the lane into an existing pattern of one-way streets in the safest and most convenient way possible. The same should apply when designing a contra-flow bus lane as part of a traffic management scheme involving a one-way street configuration.
- 3.6.3.2 A contra-flow bus lane may complicate some of the junctions in a one-way system, the main purpose of which may have been to simplify traffic movements at the intersections and increase their capacity.
- 3.6.3.3 Traffic and pedestrian conflicts which the one-way system eliminated may be reintroduced. Hence the treatment of junctions at the start and end of the lane will need special care.
- 3.6.3.4 Cyclists should not be allowed to use a contra-flow bus lane because motorists at either end of the bus lane will not expect cyclists in the contra-flow direction. Traffic signs prohibiting cyclists using the lane should be erected at both ends.

Lane Width

- 3.6.3.5 A contra-flow bus lane should be at least 3m wide. Bends and corners may need widening to enable buses to manoeuvre safely within the designated lane.
- 3.6.3.6 The use of a raised kerb or other physical separation of the lanes is not generally recommended unless the lane width such that a bus could overtake an immobilised vehicle within the lane. If a hazardous situation could arise when buses move out of the lane to overtake stationary buses, the bus lane should be widened to 5.5m. More appropriately, a bus lay-by should be provided at bus stops to enable buses to overtake stationary vehicles without a need to cross the white line. Where site constraints make both measures impracticable, a double white line may be used and the road markings amended as shown in TPDM Volume 3, Chapter 5, Section 5.9.3.

Bus Stops

- 3.6.3.7 As a contra-flow bus lane is introduced primarily for the benefit of bus passengers, due consideration must be given to locating bus stops at points of popular demand.
- 3.6.3.8 Where the number of buses using the lane is large and/or the boarding/alighting activity is high, suitable bus laybys should be provided to prevent a stopped bus obstructing the movement of buses that follow.

Pedestrian safety

- 3.6.3.9 The presence of a contra-flow bus lane in an otherwise one-way street may not be fully appreciated by pedestrians, and accidents are likely to occur if they walk into the roadway without first ensuring that the bus lane is clear.
- 3.6.3.10 Such occurrence is particularly likely when the contra-flow lane is installed sometime after the creation of the one-way system. Hence, it is preferable that both be introduced simultaneously.
- 3.6.3.11 Traffic islands should be provided for pedestrians to take refuge having crossed the bus lane and prior to crossing regular traffic moving in the opposite direction. The island should be constructed at the outer edge of the bus lane.

- 3.6.3.12 Where pedestrian flow is heavy, a signal controlled crossing is preferable to a zebra. The former gives a positive indication to pedestrians and motorists. Guardrailings should be provided primarily on the bus lane side to channel pedestrians to the crossing, although there may be problems with this owing to the gaps required to accommodate the bus stops.

Operational periods

- 3.6.3.13 As contra-flow bus lanes are provided primarily to avoid lengthy diversion of bus passengers that usually accompanies one-way systems, a 24-hour operation is recommended unless there are strong arguments to the contrary.
- 3.6.3.14 Shorter operational periods may require modification to the junction arrangements particularly at the points of entry and exit. This could be hazardous, as it could confuse motorists and pedestrians alike.
- 3.6.3.15 Contra-flow bus lanes can create difficulties for frontage properties where no servicing facilities are available off-street or in adjacent streets. In these circumstances, access to the properties by permit must be investigated at the preliminary design stage.

Signs and markings

- 3.6.3.16 Traffic signs and road markings for contra-flow bus lanes are described in Sections 2.3.2.48 to 2.3.2.50 of Chapter 2 and Section 5.9.3 of Chapter 5, all of Volume 3. In addition, the following points are significant as illustrated in Diagram 3.5.3:
- (i) T.S. 126 or similar should be erected at the location at which buses exit the bus lane, and facing the approaching traffic in the one way street. It conveys to motorists that there exists a contra-flow bus lane from that point onwards;
 - (ii) T.S. 472 or similar should be erected at the side roads together with signs indicating the prohibited movements for general traffic approaching the main road i.e. T.S. 131 or similar;
 - (iii) T.S. 481 and T.S. 482 should be erected facing pedestrians crossing the bus only lane to warn them that buses will be approaching from the direction indicated. Where it is difficult to conveniently locate these signs, RM 1136 and RM 1135 respectively should be used;
 - (iv) A supplementary plate "Except for Access", T.S. 711 should not be used unless in exceptional circumstances.
- 3.6.3.17 Advance warning for a contra-flow bus lane will not normally be necessary.

3.7 Bus-only Streets

3.7.1 Definition

3.7.1.1 A bus-only street is one which is restricted to the use of pedestrians, public transport and emergency vehicles. The use of the street by bicycles and vehicles requiring access to frontage property may be considered dependent on the circumstances applicable at each location.

3.7.1.2 A bus only street may, or may not, have a properly defined carriageway.

3.7.2 Objectives

3.7.2.1 The provision of a bus-only street is a compromise between giving buses unobstructed passage to carry passengers close to their desired destinations and improving pedestrian safety whilst allowing greater freedom of movement.

3.7.2.2 It attempts to achieve the best of the following objectives, some of which may be in conflict :-

- (i) to help people to reach the more popular destinations in the metropolitan area by bus without walking more than upto 300 metres;
- (ii) to improve bus reliability and reduce delays to passengers;
- (iii) to improve interchange facilities between different bus services by providing a more attractive environment in which the activity could take place;
- (iv) to improve mobility and safety of pedestrians in shopping and other areas attractive to them;
- (v) to improve the environment of shopping streets and other streets extensively used by pedestrians by removing unnecessary traffic.

3.7.2.3 It is not the objective of a bus-only street to attempt to achieve the time saving benefits of a segregated busway.

3.7.3 Design Considerations

3.7.3.1 Suitable alternative traffic routes should be provided for vehicles prohibited from using a bus-only street. The capacity of the road network in the area and future traffic demand should be considered.

3.7.3.2 The requirements of access and servicing of properties fronting the street, must be assessed and suitable arrangements should be provided.

3.7.3.3 On-street parking should be removed from the bus-only street and other streets to which traffic would be diverted.

3.7.3.4 Unless considerable street area is available, bus interchange or terminal facilities should be avoided. The presence of many waiting buses could be environmentally intrusive and hazardous to pedestrians where the numbers are large.

3.7.3.5 Where bus headways are short and buses have priority over pedestrians, the carriageway should be delineated by the use of kerbed footways and only so wide as to enable the free movement of buses.

3.7.3.6 Footways should be widened where practical to improve conditions for pedestrians. Guardrailings should be erected where necessary to channelise pedestrians to delineated pedestrian crossings.

- 3.7.3.7 A 24-hour operational period is recommended unless there are strong arguments to the contrary.
- 3.7.3.8 T.S. 117 together with T.S. 708 should be erected to prohibit entry of all motor vehicles except franchised buses. If cyclists are also prohibited, T.S. 116 should be used instead of T.S. 117.
- 3.7.3.9 Access to frontage property may be controlled by the issue of a permit. T.S. 712 “Except with permit” should then be erected with T.S. 117 or similar.
- 3.7.3.10 A supplementary plate “Except for Access”, T.S. 711 should not be used unless in exceptional circumstances.

3.8 Bus Priority at Junctions

- 3.8.1 Bus priority at junctions are of two types. One exempts buses from turning movements that are prohibited to other vehicles. The other provides priority to buses at traffic signals.
- 3.8.2 The object of the former is to minimize bus route distance by eliminating detours that would otherwise be effected through banned turns. It may also enable passengers to board and alight at points nearer to their origins and destinations. Although the aggregate benefits from banned turns is likely to be small, at junctions that do not involve major modifications the benefits to buses can be substantial in comparison to the low implementation costs.
- 3.8.3 If the number of buses making a right turn exceeds 100 per hour at a signal controlled junction where right turning buses are exempt from a right turn prohibition, consideration should be given to creating an offside bus lane. The bus lane should be taken upto the stop line and standard signs and road markings should be used as shown in Diagram 5.9.2.6 in Volume 3.
- 3.8.4 However, where the number of right turning buses is less than that indicated above, the junction should be marked as shown in Diagram 5.6.3.9 in Volume 3. In accordance with Regulation 60(h) of the Road Traffic (Traffic Control) Regulations authorisation in writing should be given to the Franchised Bus Company or Companies, as appropriate, that road marking 1017 or 1018 as the case may be does not apply to franchised buses, at the location or locations where they are exempt from a right turn prohibition.
- 3.8.5 Where it is proposed to allow buses to perform a manoeuvre (e.g. a right turn), which is prohibited to other traffic, it is important to consider the original reason for the prohibition and to assess whether, by allowing buses to perform the manoeuvre, the original problem will reoccur.
- Selective detection (S.D.)
- 3.8.6 Bus priority at traffic signals can be provided by having the signal timings modified to benefit selectively detected buses as they approach the signals. It is not a measure aimed at reducing the effects of traffic congestion on buses, but a means of reducing the time spent by buses at traffic signals waiting for a favourable aspect to proceed.
- 3.8.7 The main benefit of selective detection is the reduction in delay to bus passengers. Secondary benefits arise from reductions in the variability of bus delay, and hence improved reliability.
- 3.8.8 The main disbenefit is the increase in delay to non-priority traffic.
- 3.8.9 Traffic signal controllers modified to incorporate selective detection can include upto four different specialities. Two of these, ‘priority extension’ and ‘priority change’ give priority to buses. Two others, ‘inhibit period’ and ‘compensation period’ reduce the disbenefits to traffic on non-priority stages. They are defined as :
- 3.8.9.1 Priority Extension: When a bus is detected on an approach and the signals are about to change to its disadvantage, an extension of the green time allows the bus to pass through the junction without delay.
- 3.8.9.2 Priority Change: The curtailment of a red aspect on the approach of a bus so that a favourable green signal occurs.

- 3.8.9.3 Inhibit Period: An inhibit period follows a priority change. During this period no priority changes are permitted and all stages may, subject to demand, run to their normal maximum.
- 3.8.9.4 Compensation Period: An inhibit period may be modified so that extra time is granted to any stage which has an outstanding demand that was omitted during the previous signal cycle. Subject to normal vehicle saturation, such as stage may run for a pre-set period, called the compensation period.
- 3.8.10 Selective detection can be useful in mixed traffic lanes where the introduction of a bus lane is not practicable or where practicable, a set back is provided for all traffic.
- 3.8.11 Maximum benefit can be given to buses when they are on the approach which has the shortest green time.
- 3.8.12 There are several possible techniques of achieving the selective detection of buses. These include the following :-
- (i) Optical methods that depend on the accurate positioning of a bus with respect to the roadside equipment. Could present practical difficulty in selecting suitable sites, particularly in the Metropolitan Area within the Territory.
 - (ii) Ultra-sonic devices that use overhead detectors to respond to vehicles of the correct height such as double decker buses. Many devices respond only to a vehicle of the correct height positioned at a particular location relative to the device thus imposing constraints in the choice of sites. Also, detectors would respond to other vehicles of similar height. Provided the numbers are small unnecessary delay to non-priority vehicles will be introduced.
 - (iii) Infra-red and microwave techniques that could have the transmitting units fitted to the buses or on a roadside or overhead installation. High positioning of detectors required to avoid masking the direct line of transmission and the use of repeaters may be required. This could pose problems of installation and maintenance as well as increase project costs.
 - (iv) Inductive loop vehicle detection has several possible variations. They include the use of a conventional loop approximating the size of a bus, the use of pairs of loops which only long vehicles can span, loop detector signature processing based on matching a signal profile corresponding to that of a bus, the use of inductive loops coupled with a vehicle identification unit as tried out in the ERP trials.
 - (v) A bus lane with a normal inductive loop detector that would convey a message to the traffic signal controller of the approach of a bus. This combines the advantages of a bus lane and selective detection of buses without any inherent site constraints of equipment installation.
- Those techniques listed in (iv) and (v) above are well proven and suitable for application in the Territory.
- 3.8.13 Experience elsewhere is that inductive loop vehicle detection systems and transponder based systems show greatest promise. The number of junctions where priority is required, the mix of priority vehicle types, site characteristics and other needs for vehicle identification are some of the factors that need consideration in selecting a suitable system.

- 3.8.14 It is beneficial to detect buses sufficiently distant from the stop line to give the signals time to adjust appropriately. However, it should not be so far upstream that it would introduce uncertainty in the bus journey time between the detector and the stop line. A maximum distance from the stop line of 150m is recommended by the Department of Transport, UK. At that distance the use of intermediate loops may be necessary.
- 3.8.15 The positioning and spacing of loops is selected taking account of the cycle time, junction layout, degree of saturation, location of bus stops and features of the road (surface type, utility ducts, manholes etc.). Bus stops should not be located between the final sensing loop and the stop line.
- 3.8.16 More guidance on microwave vehicle detectors and inductive loop detectors is available in Section 7.3.6 of Volume 4.

Phase splitting

- 3.8.17 At junctions where the traffic signals have only one phase during which bus movement occurs, but at least two phases with no bus traffic, the bus green period could be split into two.
- 3.8.18 If the green period containing the bus flow is split into two short green periods separated by the two phases for non-bus traffic, the maximum delay to buses can be almost halved, and their bunching reduced. Diagram 3.8.1 illustrates the proposed arrangement.
- 3.8.19 To derive maximum benefit from the arrangement, buses must be able to depart during the first green period following their arrival. Should they be prevented from doing so due to queues formed along the approach to the junction, consideration may be given to the formation of a bus lane to permit queue jumping by buses.

Gating

- 3.8.20 Gating is a technique that uses traffic light signals to control the quantity of traffic allowed through an intersection from one or more selected directions. It is a technique that could be used to prevent excessively long queues forming on the approaches to closely spaced junctions that would otherwise result in a critical grid-lock. It effectively transfers the queuing to other signal-controlled intersections where queues can be allowed to form without affecting other traffic.
- 3.8.21 At the intersections where queue formations are induced, buses should be given priority over other traffic so that they are not subjected to the same delay as other traffic. Once buses pass through the 'gate' they experience fast travel times through the subsequent uncongested road network.

DIAGRAM 3.8.1: METHOD OF PHASE-SPLITTING TO REDUCE BUS DELAY AT TRAFFIC SIGNALS

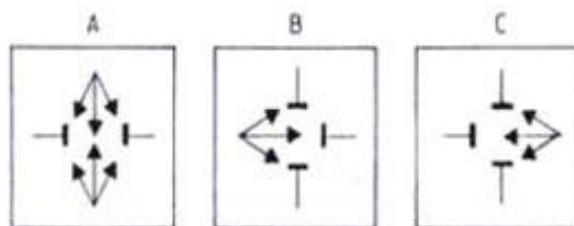
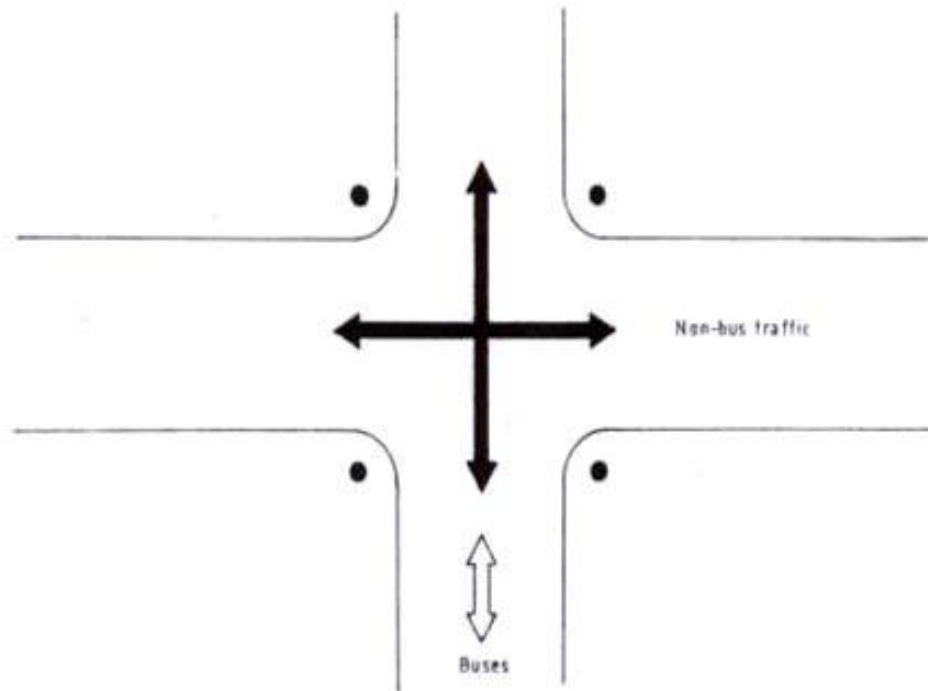
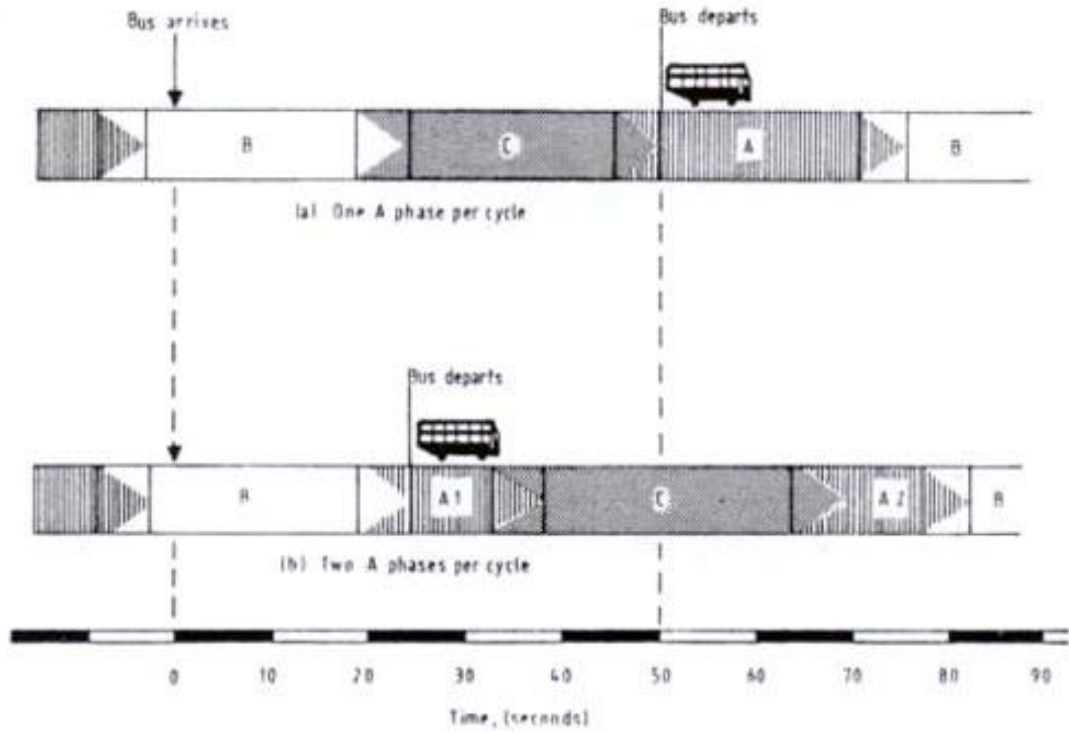

- 3.8.22 This could be achieved by a variety of methods :-
- (i) a bus lane on the approach to the gating traffic signal will enable buses to jump the queue of non-priority vehicles;
 - (ii) the gating intersection can be chosen at a location where buses already use, or can be re-routed to use, a different phase of the signals from the traffic which it is desired to restrict. The traffic that is restricted should be prevented by traffic management measures from following the buses;
 - (iii) buses can be provided a special route which by-passes the gating intersection and makes use of bus only streets, contra-flow lanes or similar priority facilities;
 - (iv) no-bus traffic can be diverted to a new route which leads to a gating intersection, while the buses continue unobstructed on the original route.
- 3.8.23 The technique is often most suitable for application during the morning peak period, when non-priority traffic travelling towards the city center, business and commercial areas can be made to queue at suitably located intersections on the major approaches.
- 3.8.24 Gating is better suited for simultaneous restriction at several locations on the road network than at an isolated intersection. It is generally well suited for area traffic control systems.
- Traffic signal co-ordinated networks
- 3.8.25 Improvements to traffic conditions in urban areas is often centred on the introduction of Area Traffic Control (ATC) Systems, sometimes referred to as Urban Traffic Control (UTC) Systems. Chapters 5 and 6 of Volume 4 provides guidance on the application of such systems.
- 3.8.26 Volume 4 details the use of TRANSYT, an off-line computer optimization method designed to produce coordinated fixed-time signal settings which minimize vehicle delay and/or the amount of stopping and starting within the signal controlled network.
- 3.8.27 A modification of TRANSYT, known as BUS TRANSYT, is also available. It is an optimisation method that provides computer calculations of fixed time signal settings which minimize total passenger delay instead of merely vehicle delay, and thus gives buses priority over other traffic.
- 3.8.28 BUS TRANSYT allows the various components of bus journey time to be separately considered i.e. free-running time between junctions, stopped time at bus stops and queuing time on the approaches to signal-controlled junctions. The predicted bus delays are 'weighted' in proportion to the higher occupancy of buses compared with private vehicles. The optimization routine adjusts the signal settings to minimize the 'performance index' based on total passenger delay rather than vehicle delay.
- 3.8.29 The reduction in bus delays with BUS TRANSYT, compared with the TRANSYT signal settings, is made at the expense of some increase in delay to other traffic.
- 3.8.30 The avoidance of abrupt changes in signal timings in both fixed time and traffic responsive systems such as SCOOT and SCAT, both rely on somewhat stable signal timings. Hence, they are not easily combined with selective detection in which signal timings can fluctuate markedly.

3.9 Busway

- 3.9.1 As previously mentioned, a bus lane is seen as a queue-jumping device to give the high occupancy vehicles an advantage at bottlenecks without measurably reducing the capacity of the bottleneck. When a series of bottlenecks does exist, or is anticipated would exist in a road network, a need could arise for providing a linked system of bus lanes commonly referred to as a busway.
- 3.9.2 A busway could be defined as a segregated roadway for the exclusive use of buses. It is a purpose-built facility either grade separated, or physically separated from other traffic at-grade. In the latter situation it may be located in the central median strip or at the side of the carriageway, dependent upon the nature of development along the road frontage and the proposed traffic arrangements in the area.
- 3.9.3 As a purpose built facility, it usually forms part of an expressway or trunk road which links large centers of population and employment. In that situation it enables the operation of a fast service over a long distance, and uninterrupted by other traffic. A considerable reduction in travel time is usually experienced.
- 3.9.4 The busway rarely extends from one terminal to the other, but usually operates over the length of the expressway. Should traffic congestion occur on the local road system along the bus route between the expressway and the terminus, suitable bus priority measures would be required to prevent possible dilution of the time savings derived from the busway.
- 3.9.5 The formation of a segregated busway on an already developed urban street network is extremely difficult, because of the problem and expense in locating a continuous strip of land for the purpose. However, when a new town is planned the opportunity can sometimes be taken to provide such a facility that would make public transport attractive.
- 3.9.6 The justification of a busway would depend on the public transport passenger demand profile in relation to the street network configuration, the estimated levels of congestion and perceived obtainable bus speeds.
- 3.9.7 As the costs of providing a busway are likely to be large, the benefits derived therefrom would need to be evaluation prior to any commitment. A threshold directional demand in excess of 20,000 passengers per hour would possibly be necessary.

3.10 “Give way to bus” Scheme

3.10.1 Objective

3.10.1.1 Franchised buses are the largest passenger carriers of road-based public transport in Hong Kong, and may encounter difficulties in exiting from the bus bays to merge to the adjacent traffic lane due to busy traffic. The Regional Offices may consider implementing the “give way to bus” scheme to encourage motorists approaching the bus bay to slow down or stop to give way to franchised buses that intend to leave the bus bay to join the adjacent traffic lanes which would allow smoother bus services while being conducive to improving road safety.

3.10.2 Typical Arrangement

3.10.2.1 The scheme comprises a set of advisory “give way to bus” traffic sign (TS2712) and road markings of “slow” (RM1141), “warning arrow” (RM1068) and “give way to bus” (RM1069). Sticker labels similar to the “give way to bus” traffic sign will be put on the back of bus bodies by franchised buses. A typical layout of the traffic scheme is shown in Diagram 3.10.1.1.

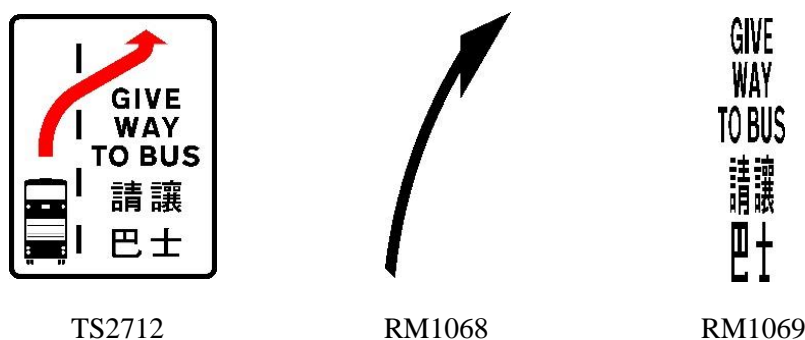
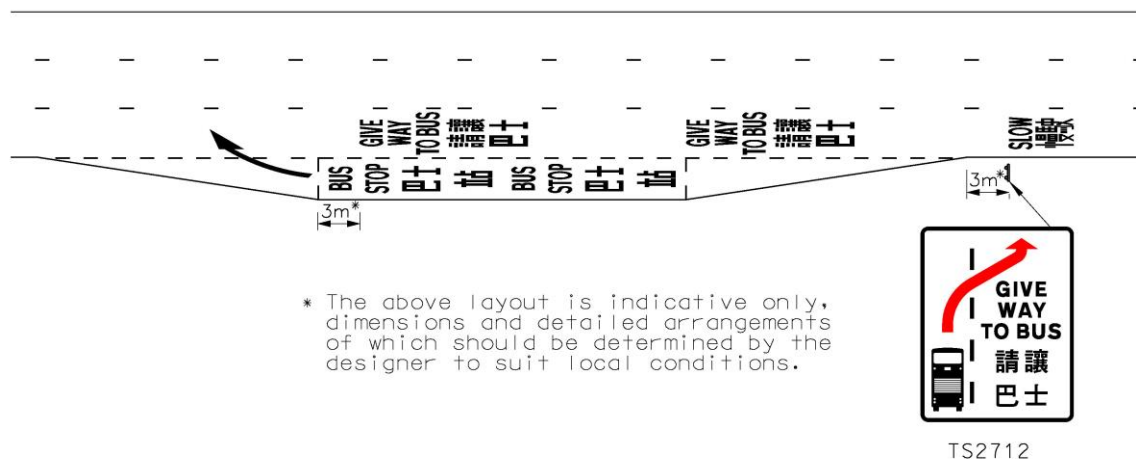

Diagram 3.10.1.1: “Give way to bus” traffic sign and road markings at bus bay



3.10.3 Site Selection Criteria

3.10.3.1 The following criteria should be taken into account when considering the selection of suitable bus stops for the implementation of the “give way to bus” scheme:

- (i) The following factors are essential for the selection of suitable bus stops:
 - (a) the bus stops should be located at bus bays;
 - (b) there are difficulties for buses to exit from the bus bays concerned, the information of which can be obtained in consultation with the franchised bus operators; and
 - (c) the bus stops should be located on multi-lane roads in the major road network of major bus corridors to optimise the benefits of the scheme.
- (ii) Meanwhile, priority considerations can be given to:
 - (a) the bus stops should preferably be located on straight road sections;
 - (b) the bus stops should be located at adequate distances from nearby junctions as set out in Volume 9 Chapter 2.4;
 - (c) the bus stops should be located on roads without speeding records and preferably with speed limits not exceeding 50 km/h; or
 - (d) there are records of accidents involving buses exiting from bus bays on roads but should preferably be not around clusters of traffic accidents that would complicate the road layouts or induce additional driving difficulties and risks.

3.11 Evaluation

3.11.1 The introduction of a bus priority scheme would no doubt benefit bus passengers but it could also disbenefit others. Since the overall objective is to provide the community a benefit from the introduction of a priority scheme, a quantified evaluation should be conducted, particularly in large schemes, to ensure that the objective could be met. Hence, an evaluation framework agreeable to various stake-holders should be formulated before implementation of the bus priority scheme. The evaluation framework should include a precise scope i.e. type of data to be collected, areas to be covered and behavioural value of times.

3.11.2 An evaluation could take the form of a 'before' and 'after' study, where a quantitative assessment is made of the factors involved. Unfortunately, a thorough quantitative analysis of all factors involved may not be possible, particularly some of the social and environmental effects. These could be described in qualitative terms and assessed on a suitable scale defined to suit the particular circumstances.

3.11.3 A detailed procedure for the assessment of bus priority measures as suggested in Reference 6 is contained in APPENDIX I. The main factors that require assessment are those mentioned in Section 3.3.3 and can be summarised as follows.

Economic

3.11.3.1 A quantified assessment should be made of the monetary equivalent of the time saved by priority vehicles and the losses, if any, to others. Any changes in bus passenger waiting times resulting from an improvement in bus regularity, and even the frequency of service should be included.

3.11.3.2 If travel conditions for non-priority vehicles deteriorate appreciably, they are likely to divert to other routes. The additional cost to divert traffic using alternative routes, and the congestion cost to traffic on the alternative routes as a result of the diverted traffic should be quantified.

3.11.3.3 The benefits and losses to those users who change mode, any new users (generated traffic), and previous users who no longer travel (suppressed traffic) should be estimated.

3.11.3.4 The changes in operating costs of priority and non-priority vehicles, changes in accidents attributable to the priority facility, and the costs of implementing the scheme should be included.

Environmental

3.11.3.5 Changes in noise, vibration and air pollution levels and changes in the visual scene arising from the priority scheme would affect not only travellers but also residents and others along the affected routes.

3.11.3.6 Changes in noise and air pollution are not difficult to quantify, but a qualitative assessment may be necessary for visual intrusion.

Social and Political

3.11.3.7 Social effects of a priority scheme follow from both the traffic analysis and environmental analysis. It helps identify any side-effects of a social nature which are not accounted for in the evaluation of economic and environmental factors.

- 3.11.3.8 The distribution of all project effects should be examined to identify which sections of the community pay the costs and who derives the benefits. If such information is available it would make it easier to formulate a strategy to sell the proposal to the public, and counteract any social or political arguments that may be used to reject an otherwise technically and economically viable proposal.
- 3.11.4 One of the main difficulties associated with using site observations to carry out assessments of bus priority schemes is that they are often part of traffic management measures. Hence, it is extremely difficult to categorise the effects due to the various components of the project, unless a stage implementation is practical and the resultant delays are acceptable. Also, the human resources requirements and financial costs for data collection could be excessive.
- 3.11.5 It is desirable that the assessment of a bus priority scheme be conducted prior to its implementation. Advantage should be taken of recently developed computer models to enable such assessment to be conducted.
- 3.11.6 An evaluation procedure for with-flow and contra-flow bus lanes developed in a recent study in the UK is given in APPENDIX II. The use of computer models for the purpose of evaluation is particularly useful, as it enables the effects of changes in key input parameters and alternative schemes to be assessed within a short time, which if performed manually would be extremely time consuming.
- 3.11.7 The computer models mentioned in APPENDIX II were specifically selected to be tested during the study, and are not necessarily the only models that could be used for the purpose of evaluation.
- 3.11.8 Bus priority schemes should be periodically monitored/evaluated to make sure they continue to be required, despite changes in land use and traffic conditions. Should the necessity arise, they could be discontinued or appropriately modified to function efficiently under the change conditions.

APPENDIX I - MANUAL ASSESSMENT OF BUS PRIORITY MEASURES**1 Introduction**

The assessment of any priority scheme will inevitably depend upon the amount of manpower and the budget available. The assessment suggested in this Appendix is fairly comprehensive, and only the largest and most comprehensive schemes are likely to require coverage of all the aspects discussed here. For smaller schemes, the efforts available may dictate that only the immediate and most obvious effects of the priority scheme are studied, so that, for example, attention is paid only to changes in travel times on the routes subjected to bus priority. Such an assessment may satisfy the traffic engineer that the scheme is working reasonably well, and is likely to be adequate in situations where considerable experience already exists of the type of priority scheme involved. In the case of new types of priority, or in very extensive schemes, however, it is well worthwhile devoting considerable time and effort to a thorough and accurate assessment.

Assessment of a bus priority scheme requires that the benefits to be derived from the scheme be compared with the costs attributable to it. Since the cost of implementing the scheme will be available in monetary terms, it is convenient to express the other costs and benefits of the scheme in monetary terms as far as possible, although in some cases this may not be practicable. Nevertheless, it is always desirable to quantify the changes which have taken place (even if they cannot be expressed in monetary terms), so that at the least a subjective judgement can be made of whether the changes produced by the scheme justify the costs involved.

Source : APPENDIX III of REFERENCE 6 with the numbering of sub-titles, table and diagram amended to suit.

Note: The value of time should be as used in transport studies in the Territory.

The aim of this Appendix is to describe the types of measurements and analyses which should be considered when evaluating a priority scheme. Although many different types of priority are discussed in the Report, the general approach is very similar, since all types of priority give rise to broadly similar effects. Certainly, different aspects of the assessment may be given different emphasis, depending upon the nature and objectives of the individual priority scheme, but it is always as well to bear in mind the many different impacts each scheme may make, since it is possible that some overlooked and detrimental effect will completely offset the planned advantages.

Priority as a component of a traffic management package

It often happens that the priority scheme is introduced at the same time as other traffic management measures (ranging from complex circulatory systems to the simple banning of parking along a bus lane). In this situation, assessment of the package as a whole will still involve the topics discussed in this Appendix, but in some cases such as overall evaluation will be inadequate because :-

- (i) it gives no indication of whether the package is better or worse for the inclusion of the priority measures;
- (ii) it cannot provide the information we require if we are to amass expertise in the design of priority scheme: this is particularly important if the priority measures involved are relatively new and untested.

If the various changes brought about by the package can be apportioned between the priority measures and the other components of the package, then assessment of the priority scheme can proceed as described in this appendix. Such an apportionment may be based on comparisons of traffic flows and delays on the priority sections with flows and delays on equivalent parts of the network covered by the traffic management scheme which do not provide priority, or it may be based on speed-flow considerations, or simply on the experience of the traffic engineer: in many cases the attribution of benefits to the priority measures may have to be rather arbitrary. If it is important to isolate the effects of the bus priority measures with reasonable accuracy, consideration should be given to installing the package in several different phases, so that the effects of each stage can be assessed separately, even though there may be practical objections to such a protracted installation.

Effects of bus priority

The effects of even a small priority scheme are potentially very far-reaching. A complete evaluation of the advantages and disadvantages would require a large amount of data collection and analysis, if only to ensure that the less direct effects of the scheme have been taken into account and shown (if this is the case) to be unimportant. In practice, however, it will generally be possible to decide in advance, from the nature of the scheme, which quantities are likely to be affected by the scheme and to concentrate data collection, before and after implementation of the scheme, on these aspects. Nevertheless, the limited effort available in any given assessment project should not be made an excuse for measuring only those quantities which the scheme is designed to improve. Certainly, it is reasonable to concentrate attention on the most obvious effects of the scheme (not neglecting aspects which are likely to be made worse) but sufficient data about more peripheral aspects should be obtained, if only to check that there have been no significant changes in them. In particular, if observation shows that there have been no significant changes in the numbers of passengers travelling on the different modes, and no changes in the routeing of the non-priority traffic, the extent of the assessment can be greatly reduced.

The most important change produced by any priority scheme is likely to be in passenger time spent travelling. Successful schemes will provide quicker running speeds for buses, but in most cases some extra delay to non-priority traffic is to be expected: this latter effect may be obscured if the priority is tied in with general traffic management improvements, so that everyone appears to gain. Less obvious still may be changes in travel time along roads outside the priority scheme: these may be disadvantageous to both bus and car passengers, and can affect even those buses which gain from the priority scheme itself. Travel times should always be measured over a section of route long enough to include not only the priority scheme but also its end effects (build up of queues at the entrance to a priority scheme, or difficulties in merging at the start of a bus lane, for example).

Potentially valuable savings in bus passenger waiting time (which is normally costed at two or three times the rate for time spent in the vehicle, because of the discomfort associated with waiting) may be available if priority enables the bus services to run with greater regularity (or improved frequency). This may well be an important factor with extensive priority schemes – certainly, long freeway bus lanes and busways could be expected to produce such benefits – but even fairly localized systems which shield buses from particularly bad congestion can improve regularity significantly.

Contra-flow bus lanes and bus-only streets in particular may save walking time for bus passengers. Although it is quite possible to cost such time savings, and include them in the overall benefit, the assessment may well be complicated by changes in pedestrian travel patterns: indeed, pedestrianisation of town centers, and the bus-only streets which go with it, provide a more leisurely environment for shoppers and may well increase the time spent walking and dawdling. If the main benefits of such schemes are environmental, any improvement in the lot of the pedestrian is better measured by a suitable attitude survey. When assessing the effects of a bus-only street, it should be borne in mind that evaluation of bus priority may be concerned with comparing the bus-only street with a completely pedestrianised area, rather than with the street when it was available to general traffic: the distinction will depend upon the reasons for withdrawing traffic from the street.

Associated with the changes in vehicle speeds will be changes in the operating costs of the vehicles. Those of buses and goods vehicles are likely to be particularly important, though their contribution to net costs and benefits is generally a good deal smaller than the time changes discussed above. Changes in the operating costs of cars because of the slower speeds involved are most difficult to estimate but are likely to be less important. If there is appreciable diversion of routeing, or shift in modal split, there will be changes in vehicle kilometers run which might have an important effect on the overall benefit. Along with these changes in the pattern of vehicle flows there may well be changes in the incidence of accidents.

Some schemes, particularly bus-only streets and busways, may have a considerable environmental impact: at present it is not possible to place a monetary value on such changes, but it is possible, and very desirable, to quantify them so that the decision taker can weigh these changes, together with other benefits of the scheme, against the costs and disadvantages. Noise, pollution and visual intrusion are aspects which can be quantified, though not costed. Many of the environmental effects can only be evaluated by asking for the subjective judgement of the people who live in or use the area affected, and such attitudinal surveys may be useful in assessing the scheme. If the priority scheme has a restraining effect on other traffic on certain routes there may well be diversion of non-priority traffic through residential areas. Again, though this is difficult to cost, the attitude of the inhabitants to this extra traffic may form a very important part of the assessment. Similarly, if social and/or political objectives are considered to be important, it will be necessary to gather information about the particular effects concerned: again, simple cost/benefit analysis is unlikely to be applicable, but if the effects are quantified some sort of subjective comparison can be made. In this category we might include the effect of such schemes as bus-only streets on trade. Penetration of pedestrianised areas by buses may improve business for shops in the area, but the value of the extra trade cannot be added to the net benefit, since the trade will to a large extent be subtracted from business elsewhere.

The many potential effects of priority scheme are summarized in Table A1.1 which also suggests which measurements should be made. The Table is fairly comprehensive – indeed, it is hoped that it will be useful as a checklist in the preparation of assessment projects – but unless the scheme to be assessed is very extensive it will be unnecessary to investigate all the aspects listed. The Table gives some indication of when particular effects are likely to be important; in many cases it will be possible to dispense with several of the less important aspects.

There is insufficient space available here to describe in detail the methods of measurement. They are described adequately in other reports and documents, which are referred to in Table A1.1. The timing and duration of the before and after surveys will always involve some degree of compromise. The longer the time between the two, the more likely it will be that there will be background changes in passenger and vehicle flows quite unconnected with the priority scheme, and allowance must be made for these. On the other hand, considerable time is generally necessary before travel patterns settle down after the introduction of a new scheme. Certainly, at least a month should be allowed between implementation and the after survey, and several months in the case of an extensive scheme. The surveys themselves should be spread over several days. Since in general the before and after surveys are likely to take place at different times of year, some correction may be necessary for seasonal effects, since passenger flows by both car and bus (but particularly bus) often show strong seasonal variations. The correction may be made in the light of previous surveys, or by reference to the behaviour of control routes unaffected by the priority scheme. Since the hours of daylight influence the distribution of journeys across the day, it is sometimes desirable to plan the before survey in autumn and the after survey in spring, or vice versa, so that the hours of daylight are similar yet the surveys are only separated by a period of six months.

The remainder of this Appendix considers those details of the data analysis which are particularly relevant to the assessment of priority schemes, and which may not be readily available elsewhere.

General Principles

The estimation of passenger time saved follows directly from the measured changes in travel times and passenger flows by bus and car. Placing a monetary value on these savings depends upon the recognition of a standard 'value of time'. Each country may adopt its own standard values for time spent travelling in a vehicle, and for evaluation purposes the rate is generally taken to be the same for both bus and car passengers, for reasons of equity. For example, accepted value of in-vehicle time for use in cost-benefit analysis are £0.30 per hour in the UK for travel in non-working time (and including the journey to work) and £2.40 for car travel in working time; in France, there is no standard value, but in Paris a value of 14F per hour for bus travel and 18F for car travel, has been used (1975 values). Consequently, in assessing the value of travel time, some estimate should be made of the proportion of travellers who are travelling in working time. Time spent in walking to take account of the extra discomfort and inconvenience involved. All values of time are generally assumed to be proportional to average income, so that they can be expected to increase in the future as incomes rise.

Suppose that for a particular mode of travel m (i.e. $m = \text{bus}$ or $m = \text{car}$) the average journey time over a route long enough to include all the effects of the priority scheme was T_{m1} before implementation of the scheme and T_{m2} afterwards. Then the average time saving per passenger is $T_{m1} - T_{m2}$ and if N_m travellers per unit time use this mode, and the standard value of time is V , the benefit to travellers by mode m is

$$N_m V (T_{m1} - T_{m2}) \text{ per unit time (1)}$$

For an effective bus lane this quantity will positive for bus passengers, while in general it is likely to be negative for car passengers. It is also likely to vary with time, since the bus lane can be expected to be most effective at the height of the peak travel period.

However, this simple situation because more complicated if there are changes in the numbers of travellers before and after introduction of the scheme. The improved bus service may attract more passengers, while additional delays may cause car travellers to divert to another route, to switch to the bus, or to stop travelling altogether. The way in which the demand for travel responds to changes in the time cost of travel is illustrated in Figure A1.1 for both bus and car travel. For bus travel, journey time is reduced from T_{b1} to T_{b2} and demand increase from N_{b1} to N_{b2} passengers. On the other hand, for car travel the journey time increases from T_{c1} to T_{c2} and demand falls from N_{c1} to N_{c2} . The curves illustrated in the Figure are 'demand curves' which represent the relationship between the cost (in terms of travel time) and demand in a situation where all other conditions remain constant (see, for example, reference 13). Introduction of the bus lane has changed both bus and car costs, however; since each demand curve depends on the cost of the alternative mode because of the competition between the two modes, the demand curves for each mode are not the same after priority as they were before. This shift in the demand curves can be seen in Figure A1.1. The total time gain to bus passengers, including the new passengers, is given by the area of the trapezium ABEC if it is assumed that the situation has moved from C to E along the straight line CE: for relatively small changes this is always likely to be a good approximation. This assumption is the foundation of the 'rule of a half' mentioned in Chapter 2 of the Report, since we have:

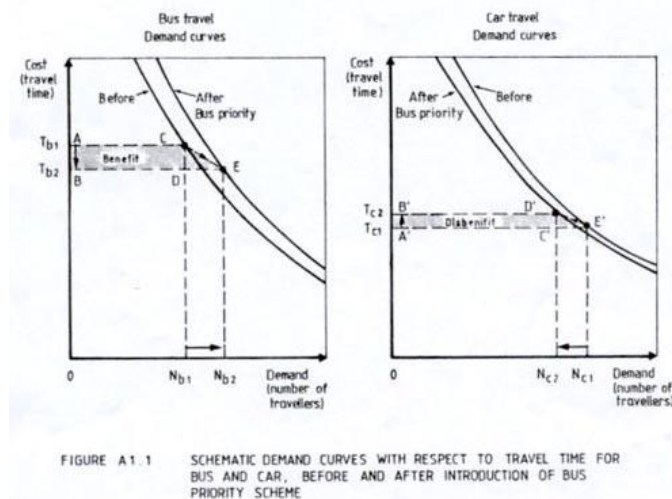

FIGURE A1.1 SCHEMATIC DEMAND CURVES WITH RESPECT TO TRAVEL TIME FOR BUS AND CAR, BEFORE AND AFTER INTRODUCTION OF BUS PRIORITY SCHEME

for the N_{b1} original travellers, saving is

$$ABDC = N_{b1}V(T_{b1} - T_{b2})$$

for the $(N_{b2} - N_{b1})$ new travellers, benefit is

$$CDE = \frac{1}{2}V(N_{b2} - N_{b1})(T_{b1} - T_{b2})$$

that is, for the new travellers, we take into account only half the time saving on average, since these are marginal travellers, and range from those people who gain the full $(T_{b1} - T_{b2})$ when they decide to travel by bus, to those who gain essentially nothing. In summary, for bus travellers the net benefit in travel time savings is given by:

$$\frac{1}{2}(N_{b1} + N_{b2})V(T_{b1} - T_{b2}) \quad (2)$$

In exactly the same way the benefit to car travellers is given by the area of the trapezium $A'B'D'E'$, i.e. by:

$$\frac{1}{2}(N_{c1} + N_{c2})V(T_{c1} - T_{c2}) \quad (3)$$

which is negative if T_{c2} is greater than T_{c1} , indicating a disbenefit.

This method of calculating costs and benefits takes into account all generated and suppressed journeys, and changes of mode from car to bus (or vice versa). If some of the non-priority traffic diverts to parallel routes, thus slowing down the traffic already on those routes, the disbenefit involved can be calculated in the same way as equation 3, using the measured flows and travel times on the diversionary routes. However, if the route used for diversion involves additional mileage (i.e. additional time is spent getting to and from the parallel routes) it is more accurate to calculate the cost of travel time changes to the diverted traffic completely separately from those for the remaining traffic on the priority route, and the original traffic on the parallel routes. It is often the case that the route of the diverted traffic cannot be determined, and in many cases it might be reasonable to assume that no additional mileage results from diversion. Nevertheless, in some comprehensive schemes the diversion required may be very circuitous, and this would justify spending considerable effort on determining the routes used and the extra travel time and mileage involved.

Other roads which are not used by diverted traffic, but which are affected by the priority scheme because the build-up of queues on the priority route, or a change in traffic light phasing, interferes with the traffic on intersecting roads, can be treated in exactly the same way if travel times and flows are measured before and after implementation of the scheme.

Bus Traveller's Time

Suppose that in a given interval of length L , k_1 buses pass along the route before installation of the scheme, which in the corresponding period afterwards k_2 buses run. For each bus the travel time can be measured before and after implementation of priority: suppose that for the i^{th} bus the time are i^{t}_{b1} and i^{t}_{b2} respectively, while the occupancies are measured (or estimated) to be i^{n}_{b1} and i^{n}_{b2} passengers. The benefit due to travel time saved in the period considered is obtained from the equivalent of equation 2, i.e.:

$$B_b = \frac{V}{2} \left(\sum_{i=1}^{k_1} i^{n}_{b1} + \sum_{i=1}^{k_2} i^{n}_{b2} \right) \left(\frac{1}{k_1} \sum_{i=1}^{k_1} i^{\text{t}}_{b1} - \frac{1}{k_2} \sum_{i=1}^{k_2} i^{\text{t}}_{b2} \right) \quad (4)$$

If there has been no change in scheduled service frequency it is preferable to sum over the same sequence of buses in the before and after periods, even though the actual running times of the buses will vary slightly from day to day and may not always fall in the same period. Otherwise, the summations should include all buses running in the period of interest. In either case, the period considered should contain a large enough number of buses that any variations in the running times or occupancies of individual buses do not have a profound effect on the result. The observations must always, of course, be average over a period of several days.

As an alternative to the formulation of equation 4, estimates of the average time saving and bus flows and occupancies during the period of length L may be made separately. If the average change in bus running time is $\langle T_{b1} - T_{b2} \rangle$, and before installation of priority the mean bus occupancy is $\langle n_{b1} \rangle$ with a flow of Q_{b1} buses per unit time, while afterwards the occupancy and flow are $\langle n_{b2} \rangle$ and Q_{b2} , the benefit over the period is :

Exactly the same calculation should be applied to buses on non-priority routes which are affected by the priority scheme: in general, bus journey times will increase on such routes.

Regularity of Service

The effect of a changed regularity of service is more complicated. It could be argued that, if buses arrive at the start of a bus priority scheme in bunches, the lane will keep them in that state whereas they might previously have been separated in the congested traffic. However, it seems intuitively that it is much more likely that greater regularity of headway will result from bus priority. It is congestion that causes irregular headways, and priority reduces the effect of congestion. Also, a faster overall journey time will allow more standing time at termini to facilitate a regular departure pattern at the start of each trip.

If a more regular headway does result from bus priority the benefit of it will be in reducing the mean wait time of passengers at bus stops. This benefit can apply to all passengers on the route, not just those who board in the priority section.

If the scheduled service frequency is better than four buses per hour, it is reasonable to assume that most passengers arrive at the bus stop without reference to the timetable, i.e. passenger arrivals are random. If so, then the average passenger waiting time for a bus which arrives H minutes after the preceding bus (i.e. 'headway' is H minutes) is $\frac{1}{2}H$ minutes. Then if all passengers at a given stop are served by a single service, and the i^{th} bus has a headway of H_i and is boarded by P_i passengers, the mean passenger waiting time at the stop is:

$$W = \frac{1}{2} \frac{\sum_i H_i P_i}{\sum_i P_i} \quad (6)$$

where the summation is over all buses calling at the stop in the period of interest. Passenger waiting times are easily calculated in this way, if data is available on the bus headways and numbers of passengers involved. In practice, however, such information is unlikely to be available for all stops along the route. An alternative approach is to survey only selected stops along the route, preferably those which have a heavy passenger loading. If the headways of all buses calling at these stops are measured, to give a mean headway of $\langle H \rangle$ and a variance of $\text{var}\{H\}$, a good measure of the irregularity of the service is:

$$IR = \frac{\text{var}\{H\}}{\langle H \rangle^2} \quad (7)$$

For random passenger arrivals it can be shown (see for example reference 14) that the mean waiting time per passenger

$$W = \frac{1}{2} \langle H \rangle (1 + IR) \quad (8)$$

If the degree of irregularity IR is measured for certain stops along the route, interpolation will give a good estimate of IR at the stops which were not surveyed. If the mean passenger loadings at all the stops are measured (or estimated, particularly for lightly-loaded stops) the total 'excess' passenger waiting time at all stops along a route can be defined as being the length of time for which passengers wait beyond the waiting time for a perfect service (i.e. beyond $\frac{1}{2}\langle H \rangle$ in (8) above). It is this part of the waiting time which is due to service unreliability, and it is particularly annoying to passengers. The total excess waiting time at all stops is:

$$W_x = \frac{L}{2} \sum_s \langle H \rangle_s IR_s A_s \quad (9)$$

where A_s is the mean passenger arrival rate per unit time at stops during the interval of length L , IR_s is the irregularity measure at stops, and the mean headway $\langle H \rangle_s$ may in general be different at different stops. The summation extends over all stops along the route. The effect of the priority schemes may be to produce significant improvements in IR_s for those stops following the priority measure, and if layover at termini is also improved because of the shorter running times, IR_s may also be improved for the stops preceding the priority measure. If there is no evidence of this latter effect, the summation in equation 9 can be restricted stops in the priority section and following stops.

Unfortunately, the situation is rarely as clearcut as is suggested above. Bus priority is most often applied in situations with high bus flows, and the buses benefitting from the scheme are likely to be on several different services. Furthermore, many passengers may be able to catch a bus on any of several different services. If the passengers arriving at the stop can be divided into several categories according to which service or group of services they must catch, the irregularity measure can be calculated for all buses serving each category, and the waiting time is calculated for each category as in equation 9. For example, suppose services X and Y serve a particular stop, and of the total passenger arrivals A per unit time a fraction a_x can catch only service X , a_y must catch Y , and a_{xy} can catch X or Y . A value of IR_x can be calculated for the arrival of buses in service X only, and a value IR_y for service Y buses, while IR_{xy} can be calculated for all bus arrivals. The total time spent by passengers waiting at the stop, per unit time and for all services, will be:

$$W_x = \frac{A}{2} (a_x \langle H_x \rangle IR_x + a_y \langle H_y \rangle IR_y + a_{xy} \langle H_{xy} \rangle IR_{xy}) \quad (10)$$

where $\langle H_{xy} \rangle$ is the average headway of all buses arriving at a bus stop. The proportions a_x , a_y and a_{xy} may not be easy to determine, however. A sample destination survey of the passengers may be necessary, though it might be possible to make crude estimates of the proportions based on the catchment populations of the services involved.

If the services involved have headways longer than 15 minutes or so (and in some circumstances much less), passengers are likely to time their arrivals to the published schedule. In this case the appropriate measures of service performance are the mean and standard deviation of departures from schedule at the stops along the route. However, there is then no simple way of calculating mean passenger waiting time. An alternative approach is to survey selected stops and actually measure passenger waiting times before and after installation of the priority scheme, by measuring the time of arrival of each passenger and the time of departure of the bus he catches. Unfortunately, waiting time surveys, apart from demanding a lot of manpower, are unreliable in many situations because the time at which a passenger starts to wait is often not easily identifiable: some passengers are in the habit of looking in shop windows or standing in doorways close to the stop, only to appear when the bus arrives. If the stop serves more than one route, or is close to stops on other routes, the problems multiply, and complicated surveys which include asking passengers for their destinations become necessary⁵². For these reasons, it might be more satisfactory to assume random passenger arrivals for services where such an assumption is not strictly justified, though if very long headway services contribute a substantial fraction of total passenger flow waiting time surveys will be unavoidable.

Whatever method is used to determine passenger waiting time, the difference in total passenger waiting time along the routes involved, in any specified period, can be costed at an accepted rate for waiting time. Conventionally, in the UK, waiting time is valued at twice in-vehicle time. If there are changes in passenger flow, the saving in waiting time can be doubled and added to the saving in in-vehicle travel time in equation 5 to obtain the net benefit due to reduction in bus passenger travel time.

Frequency of service

There may be another effect on waiting time through an increase in the frequency of buses. This may happen because of a reduction in trip length times. However, it may not occur for one or both of two reasons: (i) the extra time might be taken up at termini resting and waiting for a scheduled departure time or (ii) the company might decide to reap the benefit of the bus priority by running the same average headway as before with fewer buses. The company might well opt for this cost-saving alternative as most of the benefits of a more frequent service accrue to the passengers and, although patronage on the improved service may increase, any generated revenue would probably be small. Hence, it should be an important output of a cost-benefit analysis to determine which is the superior option. So far, most schemes analysed have been on too small a scale to produce substantial savings in total journey time, and there has been no question of improving the service frequency, but with bigger, more comprehensive schemes, it may be important to rank the available service options:

- (i) Higher frequency option: from the improvement in bus journey time on each service subject to the priority measures a new schedule can be postulated which will provide an optimum frequency of service with the available buses. This will decrease average passenger waiting times in a manner which can be calculated, for random passenger arrivals, as in equation 8. Such an improved service would also attract increased patronage to an extent which can be crudely estimated from consideration of the total generalized cost of bus travel (i.e. time plus money cost of travel) and our very imperfect knowledge of the elasticity of demand for bus travel with respect to generalized cost (see, for example, reference 17). The benefits to these additional travellers are obtained from applying the 'rule of a half' mentioned previously to the decrease in waiting time, but in most practical situations this contribution to the total benefit will be very small. It should be noted that although such extra patronage provides extra revenue for the bus company, the revenue paid is a transfer payment and should not be included in the benefit available to the community as a whole.
- (ii) If the original service headway is retained (but with whatever regularity improvements the priority can confer) the company may be able to run the service using fewer buses than previously. If so, the benefit to be gained must be estimated from the reduction in buses used, bus kilometers run and bus hours by means of a bus costing model (such as is described in references 15 and 16). The available savings can be expected to vary with time

of day, and if fewer buses are used in the peak the cost savings are likely to be particularly valuable.

In assessing the value of an extensive priority scheme, the potential overall benefit must include whichever is the greater of the benefits from options (i) and (ii). If this is the greater than the actual benefit obtained, because the option chosen is not the one which maximizes the community benefit, consideration might be given to changes in the bus services offered.

Car Traveller's Time

Those travellers who remain on the same route and mode are likely to suffer from an increase in travel time costs in the way described in this section. If the flow of cars is Q_{c1} per unit time before installation of the scheme and Q_{c2} afterwards while the respective average car occupancies are n_{c1} and n_{c2} , the benefit in terms of car passengers' travel time over a period of length L is:

$$\frac{VL}{2} (Q_{c1} n_{c1} + Q_{c2} n_{c2}) (T_{c1} - T_{c2}), \quad (11)$$

if the before and after mean travel times are T_{c1} and T_{c2} respectively (in general we might expect $T_{c2} > T_{c1}$). A similar calculation should be applied to all other roads on which speeds are affected by priority scheme. Note that in dealing with both bus and car passengers' travel time changes as described here and in section 4, the effects of suppressed and generated trips, and of trips transferred from car to bus, are automatically taken into account.

Resource cost gains and losses

Although it is proper to consider a saving in travellers' time as a benefit to the community, the material wealth of the community will only be increased insofar as a proportion of this time is put to productive use. In general, it might be argued that this proportion will be small. Savings in vehicle operating costs, on the other hand, are resource cost savings, because they avoid the expenditure of non-renewable materials, energy, and labour. Similarly, expenditure on roads and buildings must be considered to be a resource cost. In computing these savings any tax component of the costs involved must be excluded, since all taxes are transfer payments and do not involve the expenditure of real resources.

Vehicle operating costs

(i) Bus costs

These may be changed in one of two ways. The first is that the total number of buses required to run the service may go down. This was discussed in section 4, in which it was stated that it was an alternative strategy to reducing headways. The second is that the costs per bus may alter. A bus may run more kilometers daily or have a higher average speed or need to be away from the garage for a shorter period. In either case, the changes in cost might possibly be modelled with the type of bus costing model described in references 15 and 16. The savings may be relatively unimportant for a small bus lane scheme, but might be considered in an extensive priority scheme.

(ii) Car costs

The effect of bus priority on car costs is much more complicated and speculative than the effect on bus costs. The first effect is that, to the extent that travellers switch modes, there will be a reduction in car kilometers run. There will thus be a saving in running costs, maintenance and depreciation net of the taxation element. To quantify this, it will be necessary to estimate the number of trips diverted from car and the average length of each trip. Surveys of bus passengers, in which new riders are asked about their previous mode of travel are necessary to determine what changes have taken place in modal split. If car travel is already restrained by congestion, however, it is possible that some of the car trips which have been transferred to bus will be replaced by newly-generated car trips on the relatively emptier streets, so that any estimates of car kilometers saved based on modal-split changes alone could be overestimates: car-flow measurements are likely to be more reliable. A standard marginal running cost per kilometer can then be applied (in the UK, for example, as given in reference 18).

A result of a large and successful bus priority system might be to reduce the number of cars licensed, in which case the resource costs involved in constructing new cars will also be reduced. However, it may be reasonable to assume there will be no significant effect for the sort of priority scheme that is current being introduced.

There will also be a resource cost effect if a significant fraction of car traffic switches to alternative routes, and extra distance is involved. This should be costed at the standard rate, and is in addition to the increase in traveller's time, dealt with in section 4.

Finally, there may be a change in the operating costs of each car which suffers extra delay by remaining on the priority route. Crawling and queuing may be expected to lead to different petrol consumption and wear and tear than an easier, faster journey. It would be possible to cost the extra fuel and oil used (at the idling rate, perhaps) during the additional delay, but this is likely to be insignificant in relation to time savings, etc. More important is likely to be the cost of increased maintenance and repairs, but this would be extremely difficult to cost.

(iii) Goods vehicles

Goods vehicles may suffer a change in operating costs for the same reasons as discussed for cars above. In line with the remarks on cars, priority schemes might be expected in general to increase the operating costs of goods deliveries, but in cases where the scheme achieves a decrease in congestion (and particularly in some comprehensive schemes) the costs to goods vehicles could decrease significantly. Any extra distance involved can again be costed at some standard rate (see reference 18), and in this case any changes in travel time should also be costed at the appropriate standard rate per unit time (consisting mainly of crew costs).

If there are appreciable changes in the time required for deliveries either on the priority routes or because of changes in the general level of congestion, the sizes of the vehicle fleets required to do the same work as before may be changed. This is only likely to be true for vehicles which spend a large portion of working time running in areas affected by the priority scheme. If it seems likely that the priority scheme will change the length of their working day appreciably (and this could be an important consideration with comprehensive schemes) it may be necessary to survey the vehicle operators to determine whether fleet sizes have been modified in accordance with changes in the working time required, and the costs or savings involved.

Priority schemes which include bus lanes or bus-only streets may make deliveries to shops and other businesses more difficult: deliveries might be restricted to particular times of day, or transferred to the backs of the shops. If this effect seems important some estimate of the extra cost involved should be made, possibly by special surveys of the delivery vehicle operators.

(iv) Taxis

Although the average customer occupancy of a taxi is less than the occupancy of a private car, it is reasonable to treat taxis separately. If taxis are allowed to use the priority scheme along with buses, as in some schemes, calculation of the benefits due to decreased travel time and operating costs parallel those for the bus. If not, taxis are likely to suffer the same additional delays as cars. Taxi delays should be costed at the appropriate cost rate (which may be taken as equal to the marginal car operating cost, plus the cost of the driver's time at the appropriate wage rate) plus the passenger time (which is likely to include a sizeable proportion of working time) for the observed average occupancy. The cost of extra delays can be appreciable, since the costing involved will be much higher than in the case of car operating costs.

Road System Costs

Even for very simple priority schemes the capital costs of installation can be considerable, and they must be included in any respectable evaluation. There will also be some running costs, upkeep costs and depreciation charges associated with the new equipment (signs, marking and traffic signals) and these should equally be allowed for. There may also, however, be changes to the track costs of the roads in question. For example, on a two lane carriageway the introduction of a bus lane will cause one lane to be more heavily used and the other lane less heavily. It will also cause some parallel roads to be more heavily used. In the bus lane itself the lateral position of the bus is fairly restricted, and this can lead to 'tracking' problems, where the bus wheels wear ruts in the road surface, thus requiring extra maintenance. The road cost effects may partly cancel out, but should in any case be considered: it may be possible to derive appropriate relationships from information given in reference 20.

Finally, some speculatively, a bus priority scheme which reduces the amount of private car travel in an urban area either by suppression of trips or by diversion to public transport may have a resource cost benefit due to the reduced need to provide car parking space and road space elsewhere on the network. Such an effect is unlikely to be measurable in the case of a small scheme but could become

significant for a larger system. It is clear that any delay in the need for new road construction and improvement is potentially of very great quantitative importance. At a 10 per cent discount rate even six months' delay is worth £50,000 for each £1m of investment.

Accident Cost

A before and after study should reveal the effect on accidents, if any. Standard values of life and injury are normally applicable; these can be questioned on several grounds but, for consistency, such generally accepted values should be used to value any changes that occur. One component is concerned with the value of lost production, and is therefore a resource cost item. The other component, the valuation of the pain grief and suffering element, is a value judgement and cannot be reliably estimated, but it is desirable to retain the full standard values in assessment so that different projects and rates of return can be compared. See, for example, reference 19.

Investigation of the effect on accidents should cover the entire area affected by the priority scheme and its secondary effects. The pattern of pedestrian accidents may well be changed by schemes such as bus lanes or bus-only streets, since the exposure of pedestrians to moving buses may be increased, while at the same time exposure to other traffic may well be reduced: consequently bus/pedestrian accidents might increase, while the overall accident rate could decrease, remain constant, or increase. There may be a 'learning' period of several months following introduction of the priority scheme, when there is an increase in accidents because pedestrians are unfamiliar with the new pattern of vehicle flows (this is particularly true of contra-flow bus lanes). It is important, therefore, that the study is continued well beyond this learning period, and, as with most accident data, it may take several years before firm conclusions can be drawn. During this period there may be other changes unconnected with the priority system, and these must be taken into account.

Summing the costs and benefits

Once all the quantifiable costs and benefits have been determined, the net benefit can be obtained as the sum of the (positive) benefits minus the sum of the costs (or 'negative benefits'). If the net Present Value method of evaluation is to be used (see section 7) it will also be necessary to estimate benefits for some years into the future, where the value of travel time and the cost of labour may be assumed to increase with average income level, so that some at least of the costs and benefits will change with time.

In summing all the benefits, the total money value of the changes in travel time, using the 'rule of a half' for generated or suppressed trips, should be summed for bus and car passengers (and taxi passengers, if appropriate) using the expressions of section 4, and to this any saving in bus passenger waiting time due to changes in service reliability or frequency (section 4) should be added, after costing them at the appropriate rate for waiting time. If there are changes in vehicle kilometers run they should be costed, net of any taxation element, for buses, cars, freight vehicles and taxis separately and added into the overall benefit. If the effect of the changed traffic patterns on road capital and maintenance costs is not estimated explicitly as in section 5, it might be desirable to make some allowance for these quantities by including in the vehicle running costs that part of the taxation element which is estimated to cover provision and maintenance of roads (for example, in the UK this type of estimate is made in reference 20).

However, there is one additional term in the calculation of the net benefit which will detract from the saving in resource costs obtained when there has been a decrease in vehicle kilometers run. The saving in total cost (including the tax element) will eventually appear as expenditure on other goods (after all, the opportunity for such expenditure is one of the reasons why a traveller may abandon his car and use public transport: the public transport trip may well take longer than the car trip, but this disadvantage is offset by the money saved in not using the car, a benefit which can only be realized if the money saved is spent on other goods). The extra resource cost involved should be subtracted from the sum of other benefits. This term is often ignored in cost/benefit calculations of this type, and indeed at first sight it is counter-intuitive, since if the taxation element in car costs is larger than for other goods a passenger transferred from car to bus might well show a net loss on this basis; nevertheless, it is important that the decision-maker be presented with as accurate an account as possible of the true costs incurred in his decision, and expenditure on alternative goods is a real cost to the community. This final term should be calculated by summing the changes in total vehicle running costs (including tax), for bus and car (and taxi and goods vehicles where applicable) and discounting the sum by the average rate of taxation on all goods. The resultant sum is the estimated resource cost of the transferred expenditure to other goods, and should be subtracted from the net benefit.

The form of evaluation

The various elements in the cost-benefit analysis have been examined and set out. It is feasible in most cases both to gather the necessary data and to convert it to money values. Most of these costs and benefits appear as continuing items, in the form of cost per time period, except for savings, or delay, in road investment (which may occur only in certain years of the project) and the capital cost of the bus priority measure itself. Since the capital cost is often small in relation to other costs and benefits (so that a rate of return investment criterion may be unduly sensitive to the capital cost), and in view of the continuing nature of most of the items, the most appropriate evaluation measure is the 'net present value'.

The Present Discounted Value of a sum of money accruing n years in the future is that sum discounted at some test discount rate r over the n years. The Net Present Discounted Value (NPV) is the present value of the stream of net benefits (i.e. the benefit less cost for each year, so that the net benefit for any year might be positive or negative). If the stream of benefits over the n years is written as B_1, B_2, \dots, B_n , and for simplicity the costs and benefits are assumed to occur at the beginning of each period, the net present discounted value is given by 21 :

$$NPV = \frac{B_1}{(1+r)} + \frac{B_2}{(1+r)^2} + \dots + \frac{B_n}{(1+r)^n} - C_0 \quad (12)$$

$$\text{or} \quad NPV = \left[\sum_{t=0}^{t=n} \frac{B_t}{(1+r)^t} \right] - C_0$$

where C_0 is the capital cost of the scheme.

The criterion to be applied is simply that this value should be positive, but this evaluation depends on two decisions: the value of r , i.e. the rate of discount employed, and the value of n , i.e. the time period over which costs and benefits are to be considered. In general, a standard value of r is likely to be recommended by government in each country (in the UK, for example, the current rate is 10 per cent) and the adoption of such a standard value in evaluation of priority measures enables comparisons to be made both between different schemes and with alternative uses of the resources. The decision on the time period of the analysis should be more flexible according to the nature of the scheme and the lifetime of the assets involved, but in any event benefits from a long time into the future tend to be very small when discounted at 10 per cent p.a. If it is clear that the major part of the investment will wear out after a particular time, this period can be used to define n ; otherwise some standard period such as 5 or 10 years may be adopted, or the study might determine the number of years required for the NPV to become positive (assuming that capital costs make the NPV negative in the first years).

The NPV criterion gives an unambiguous answer to whether a measure is worthwhile only in conditions of unlimited capital availability or where the test rate is high enough to enable all schemes with positive NPV to be financed out of available funds. For many bus priority projects the capital expenditure may be a minor item, so that funds are not hard to find. However, where funds for the capital expenditure and continuing subsidies are scarce, or where there is a considerable risk element, either a higher discount rate might be employed in calculating the NPV, or the scheme may be required to have a NPV greater than some specified positive value. This value should be fixed as a proportion of, say, the gross discounted benefit so as not to favour the larger schemes.

For a very small scheme, the costs may not be large enough to justify the resources involved in conducting a NPV calculation. A simpler alternative would be to calculate a first year rate of return, taking the net benefit in year 1 as a percentage of capital outlay: if this is greater than the test discount rate the project is judged to be worthwhile. However, it should be remembered that the first year rate of return can be very misleading (especially where capital investment is a small item) if the net benefits vary from year to year. This may be very much the case with priority schemes, since road congestion

may be expected to increase with time, values of time will rise with real incomes, future road investment may be affected, bus fleet altered, etc. The first year rate of return, therefore, is unlikely to provide a reliable comparison between schemes where the net benefits behave differently over time.

In some schemes, it will not be possible to quantify all the costs and benefits, particularly where environmental effects, or social and political considerations, are important. Nevertheless, it is still necessary to provide the decision-maker with an estimate of the NPV based on costs and benefits which can be quantified, together with information on those items omitted from the calculation (and these, too, should be quantified as far as possible, even though they cannot be expressed in money terms). If the two sets of factors operate on balance in opposite directions (e.g. a negative NPV with environmental benefits, or vice versa) the decision-maker must decide what weight to put on the factors involved, but at least he will have been provided with all the relevant data on which to base a decision.

Although the NPV criterion is simple in concept, in practice there are many potential pitfalls, and it should be employed only if the principles involved are well understood. Space permits only the major points to be discussed here, but a fuller treatment is given in references 21 and 22.

8

Conclusion

It is quite clear that a comprehensive evaluation of bus priority is a difficult, expensive operation. Unless it is done properly, however, it is unlikely that the best possible systems will be designed for our towns, and the propagation of badly-designed priority systems could well bring attempts to help public transport into disrepute. It is not possible to lay down hard and fast rules for the assessment of priority schemes in general: what must be included and what can be omitted will depend on the nature and circumstances of the particular scheme. This Appendix has attempted to give comprehensive coverage to the potential effects of bus priority, and in many cases a satisfactory evaluation may involve only a few of the aspects listed here. But where the priority scheme is more than just an adaptation of a system which has already been properly assessed in several other locations (and at the time of writing proper assessments of any type of scheme are few and far between), or where the system is extensive enough to have considerable impact on travel habits, it is worthwhile taking considerable trouble to ensure that the assessment is thorough and complete.

TABLE A1.1
Summary of the effects of bus priority, and notes on assessment

Effect on	Mode	Expected benefit (+) or cost (-)	Expected changes	Measurements required (measurements are made before and after implementation of the priority scheme, so that changes can be determined)	Notes
Travellers' Time	Bus	+	Decrease in bus travel time along priority route.	Overall bus travel times along priority section, flow of buses, numbers of passengers on buses (see section 4).	Likely to be major benefit of most priority schemes. Important to measure travel times over sections which extend well beyond priority area, since additional congestion due to scheme may delay bus before it reaches priority scheme.
			Decrease in passenger waiting time due to :	Times of arrival of buses at selected stops along route affected by priority :	May be no significant effect with very localized priority schemes, but expect benefit in extensive schemes. Priority might improve regularity not only in priority area, but also on route following priority. Large improvements may provide improved terminal departure times, so that service is better even on route preceding priority area.
		+	i) improved regularity of bus service;	For headways less than 15 minutes assume passengers arrive randomly and calculate waiting time from bus arrival pattern (see section 4). For longer headways compare actual arrival times with schedule, and may have to measure actual waiting times.	
		+	ii) higher frequency service made possible by shorter travel times.	Determine whether there have been changes in scheduling, particularly in service frequency, and effect on waiting.	See section 4.
		-	possible increase in bus travel times (and perhaps passenger waiting times) along non-priority routes affected by diverted traffic, or by build-up of traffic queues on priority route.	Measure bus travel times and occupancies along routes surrounding priority area. If changes in running speed are established, may also be necessary to consider effect on regularity.	Important if implementation of priority scheme brings about significant diversion of non-priority traffic, or if lengths of non-priority traffic queues are significantly increased (see section 4).
		+	Possible decrease in time spent by bus passengers walking from bus stop to required destination.	Survey passenger destinations and determine mean distance walked. Possibly attitude surveys to establish improvements in convenience: see section 3.	Often an important consideration with contra-flow bus lanes, and may be main objective of scheme. Possible that implementation of scheme may bring about change in destinations of passengers.

Effect on	Mode	Expected benefit (+) or cost (-)	Expected changes	Measurements required (measurements are made before and after implementation of the priority scheme, so that changes can be determined)	Notes
Travellers' Time	Car	-	Increase in car travel time along priority routes.	Overall vehicle travel time along route, flow of cars, occupancies (see section 4).	It should be noted that in many schemes no disbenefit to cars has been observed This may be due to traffic management changes implemented simultaneously with priority but it is possible that segregation of buses from general traffic leads to more efficient traffic flow.
		-	Increase in car travel time on non-priority roads affected by traffic diverted from priority route, or on roads which cross priority route and are affected by increased queues and/or changes to traffic light phasing.	Measure car journey times, flows occupancies on all roads which might be affected by priority scheme. Check for changes in traffic light timing.	If car flow on priority route decreases significantly, there may be diverted traffic on parallel routes. Severe restraint may suppress some trips, divert others to bus, or car occupancy might increase. If there are no significant changes in car flows, measurement of journey times on on-priority streets can be omitted unless other factors (traffic lights, queues) affect these streets.
		-	Parking time may increase if priority scheme displaces existing parking spaces.	Best approach is likely to be a sample survey of time taken to park a car (and walk to destination) by actually parking car to visit a selection of destinations.	Important where priority scheme has displaced parking spaces (i.e. in some bus lane scheme "C though in many cases should compare with no priority situation where parking has been removed).
	Pedestrian	+/-	If pattern of traffic flow changes, time for pedestrians to cross street may change.	Observe pedestrian crossing times, or measure time required to walk between sample origin-destination pairs, where appropriate. But number of crossing movements may change (see section 3) and the only practical assessment may be a pedestrian attitude survey.	Likely to be a consideration where bus-only streets are involved, since pedestrian environment is changed considerably, but valid comparison may be between bus-only street and pedestrian precinct, not between bus-only street and general traffic street.

APPENDIX II - EVALUATION PROCEDURE INCLUDING USE OF COMPUTER MODELS

The steps involved in the evaluation procedure described in this Appendix are outlined in the form of a flow chart shown in Figure AII.1. Descriptions of each step are given in this Appendix, referenced to sections in the main report as necessary. The procedure is intended to include the main elements of evaluation that are likely to be involved to include the main elements of evaluation that are likely to be involved at the majority of sites. The relative weighting of the importance of these factors (e.g. economic return against environmental impact) will vary between sites and require judgement, and other factors which have not been identified here may be significant on a site specific basis. The following notes are related to the flow chart illustrated in Figure AII.1.

IDENTIFY PROBLEM

- (i) Typical problems which may warrant consideration to be given to the introduction of a bus lane include :

- (a) With-Flow Bus Lane

Traffic congestion causing high and variable delay to buses with associated undesirable effects (e.g. unreliable service, loss of patronage etc.)

SOURCE: APPENDIX E OF REFERENCE 9 with title amended to suit.

NOTE: References in the APPENDIX refer to relevant sections in REFERENCE 9

FIGURE AII.1: FLOW CHART OF BUS LANE EVALUATION PROCEDURE

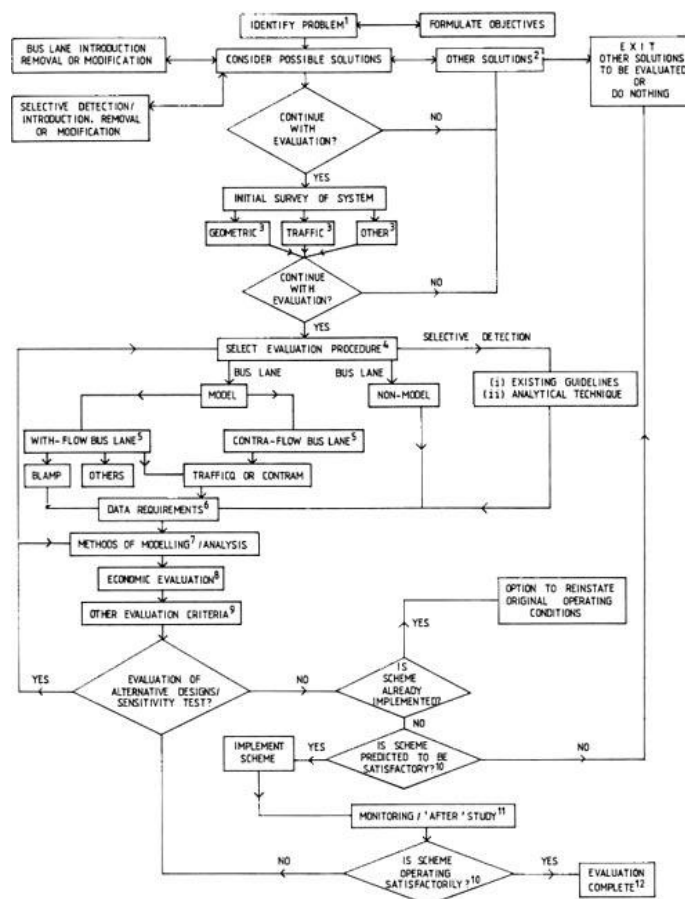

- (b) Contra-Flow Bus Lane

One-way system has increased journey distance/time for buses, separating outward and return routes and causing additional walking time for passengers, loss of patronage, etc.

Other reasons may include the segregation of buses from other traffic where bus flows are high, reducing accident risk (e.g. to pedal cyclists), altering the modal split in favour of public transport, the control of parking/access, etc.

- (ii) Typical problems which may warrant consideration to be given to the removal or modification of an existing bus lane include :
- High delays being suffered by non-priority vehicles possibly exacerbated by the presence of the bus lane.
 - Traffic blocking upstream junctions and side roads, causing increased delay to traffic not wishing to use the bus lane link and negating the benefit to priority vehicles.
 - Traffic diverting to local environmentally sensitive minor roads or over a wider area.
 - Parking and/or moving violations requiring frequent enforcement and reducing effectiveness of bus lane.
 - High accident rates on the link after introduction of the bus lane.
 - Suspicion of non-optimum design of bus lane (e.g. too short, too narrow, non-optimum setback for the prevailing signal timings, etc.)

2 OTHER SOLUTIONS

Other solutions to the problem(s) identified may include :

- Road construction/widening.
- Junction re-design to improve capacity (e.g. conversion to roundabout/signals, flaring, signal staging/timing improvements).
- Introduction of U.T.C. system. Traffic management measures (e.g. restraint, parking prohibition).
- Re-routing of bus service(s) or other bus priority measures.

If bus lane existing, typical solutions listed above may apply, although others (excluding removal) may include :

- Extension of vehicle classes permitted to use the bus lane.
- Amendment of operational period.
- Re-design.

3 INITIAL SURVEY OF SYSTE

No Bus Lane Existing

Geometric details required to ascertain whether there is sufficient existing road space for the bus lane (or whether road could be widened) in accordance with H6/76 and other design guidelines. Relevant measurements include :

- Link length(s)
- Road/carriageway/lane widths
- Number of lanes
- Curvature, gradient, etc. (approximate)
- Junction dimensions (e.g. to check whether modifications that may be required (particularly for a contra-flow lane) could be carried out)
- Layout of surrounding network (to consider diversion possibilities)

Traffic details required to :

- (i) Initially consider whether the bus lane might be worthwhile for priority vehicles by measuring bus flows/occupancies and :
 - (a) With-Flow Lanes
The journey time of vehicles from the back of the queue to the proposed end of the bus lane, at regular intervals during the period of interest on one or (preferably) more days. Include possible packing effects This gives an estimate of the time able to be saved by priority vehicles.
 - (b) Contra-Flow Lanes
Measurement will depend on system being proposed, but would typically require regular measurement of journey times during period of interest to compare with estimated journey time on new route.
- (ii) Initially consider the extent to which the bus lane might disbenefit non-priority vehicles.
 - (a) With-Flow Lanes
If it is known that junction capacity will be reduced (e.g. due to no setback being provided) it may be necessary to model the situation in more detail at this stage. Otherwise :
 - Measure maximum queue lengths to estimate new maximum queue lengths with the bus lane, assuming the same number of vehicles queue.
 - Consider likely diversions, effects on side road traffic blocking back, etc. from information above.
 - Consider effects of/on turning traffic, particularly opposed right turners and vehicles following.
 - (b) Contra-Flow Lanes
Depending on the characteristics of the proposed system, measurements may be required of :
 - Non-priority traffic flow in the stream(s) currently including buses (which are to be removed) to estimate for example, the effect of junction modifications associated with the bus lane.
 - Traffic flow in the opposite direction to that of the proposed bus lane, to assess the effects of the loss of a lane and (perhaps) of junction modifications.
 - (iii) Others items which may be affected by the bus lane and require measurement/assessment include:
 - Parking provision/activity
 - Loading/unloading provision, loss of access, etc.
 - Bus passenger walking times (e.g. due to relocation of bus stop in contra-flow system)
 - Pedestrian activity (e.g. volume and location)

Bus Lane Existing

The feasibility of bus lane removal/modification will not normally be in doubt, and, at this stage, an indication of the disbenefit to those vehicles concerned may suffice through its removal/modification. (Removal will normally only disbenefit priority vehicles whereas modification could affect priority and/or non-priority traffic.) This may be obtained from relevant measurements as described above. Measurements associated with a more detailed evaluation and/or a 'before' and 'after' study are discussed in Item 6 below.

4

SELECT EVALUATION PROCEDURE

- (i) Computer modelling is recommended for the evaluation of with-flow bus lanes if :
- (a) The proposed system is complex (e.g. more than one link affected).
 - (b) Numerous alternative options are to be assessed (e.g. variations in layout, signal timings, etc.)
 - (c) The bus lane will restrict junction capacity.
 - (d) Traffic diversions and/or blocking back across significant side roads and/or through upstream junctions is likely to be significant (as determined from measurements described in 3 above).

Modelling is also recommended when it is proposed to remove or modify the bus lane and any of these circumstances exist.

- (ii) For with-flow bus lanes on single links where none of the above conditions apply, simpler non-modelling techniques may be applied.
- (iii) An adequate evaluation of a contra-flow bus lane will normally involve computer modelling, unless journey time considerations are not significant or can be easily estimated. Modelling allows an evaluation to be made of :
- The effects of change in traffic assignment and consequent delay.
 - The effects of modifications in junction control characteristics.

5

MODELLINGWith-Flow Bus Lanes

Subject to the comments in Sections 7.3 and 8.3. BLAMP is considered to be the most suitable model for the evaluation of the effects on journey time/delay of a with-flow bus lane on a single link provided the following effects are insignificant :

- Movements to or from side roads
- The blocking of other traffic not wishing to use the bus lane link
- Traffic diversions

Other models which can also be used in these circumstances include ARCADY, PICADY or OSCADY, although these have not been evaluated in this study.

TRAFFICQ or CONTRAM can be used under these circumstances although where a setback exists or is proposed which restricts junction capacity, modelling accuracy is diminished. Subject to this constraint, either of these models can be used for evaluating larger networks containing with-flow bus lanes.

The characteristics of these models are described in Section 7.

Contra-Flow Bus Lanes

Either TRAFFICQ or CONTRAM are suitable for the evaluation of the effects on journey time/delay (and fuel consumption) of a contra-flow bus lane. CONTRAM is preferred where vehicle routes are uncertain or complex and/or where traffic signal optimization is required.

DATA REQUIREMENTS

(i) Modelling

The main data requirements for each model are listed in Table AII.1, further details being given in the individual program user Guides. The models are particularly sensitive to the following parameters which should be carefully measured :

- (a) origin-destination traffic flows (in, say, 15 or 30 minute intervals over the modelled period depending on the variation in traffic flows related to the model capabilities). These will typically take the form of classified turning counts of each relevant junction. A count upstream of any queues likely on the bus lane link is also required to give a measure of traffic demand. (A count at the junction immediately downstream of the bus lane will only reflect junction capacity and should not be used as the demand flow.) Circulating flows on roundabouts (where present) are also required.
- (b) stop line saturation flows at traffic signals, which should preferably be measured (rather than predicted) for each relevant link on a lane-by-lane basis if TRAFFICQ or BLAMP are being used. The saturation flow for the lane(s) adjacent to the bus lane is also important in BLAMP. Total stop line saturation flows for each link are required by CONTRAM. The saturation flow measurements should also allow estimates to be made of starting and ending lost times. A key element in the evaluation will be the assumption(s) made about the effect of the bus lane on saturation flow/capacity, i.e. will/has the bus lane reduced the capacity or are other factors overriding (e.g. exit blocking, presence of bus stops, etc.)? This may not be clear from these measurements and careful site observation/judgement will be required

TABLE AII.1: MAIN INPUT REQUIREMENTS FOR MODELS

ITEM ¹	MODEL ²		
	TRAFFICQ	CONTRAM	BLAMP ⁴
<u>Main Parameters</u>			
Link lengths	*	*	*
Number of lanes	*		*
Storage capacity of link		*	
Vehicle dimensions	*	*	*
Roundabout geometry (if applicable)	*	*	
Vehicle routes	*		
Origin-Destination traffic flows	*	*	
Arrival flows			*
Flow profile	*	*	*
Cruise time/speed	*	*	
Saturation flows	*	*	*
Form of signal control ^v	*	*	
Signal timings	*	*	
<u>Specifications, Ranges, etc.</u>			
No. of section lengths for link	3	1	3
No. of vehicle classes	1	3	2
Maximum number of links	~60	200	1
Maximum number of vehicles routes	2	^v	1
Number of saturation flow inputs per link	2	1	4
Maximum number of time intervals for model	6	12	>15
<u>Values of other parameters used in modelling</u>			
Simulation increment (secs)	3		
Vehicle packet size		1 or 2	
Queued vehicle headway-cars (m)	5.5*	5.5*	5.5*

1^v :Fixed time (linked or unlinked) or vehicle actuated for TRAFFICQ

:fixed time or optimized cycle time/green splits for up to 12 time period for CONTRAM

Fixed time for BLAMP, changed at any time during modelling

2: Model containing parameters listed are marked *

^v= only restricted by network layout

* From observations and as recommended in TRAFFICQ. However, in traffic streams containing "significant" proportions of commercial and public service vehicles, a value of 6.0m may be more appropriate.

- (c) traffic signal timings.
- (d) roundabout entry capacity (if applicable).
- (e) cruise speeds (less important where 'continuous' queuing occurs).

(f) vehicle journey times for priority and non-priority vehicles. These are required for calibrating the model. Measurements are required on the bus lane link itself, between a point upstream of any likely/existing queue on the link and either the end of the bus lane or the stopline of the downstream junction. (The later location is preferred where the setback is not fully used.) Journey times may also need to be measured on diversion routes and on significant side roads which may be/are affected by the bus lane. (Simpler queue length measurements are likely to be sufficient for the side roads). It is recommended that journey time measurements be obtained through registration number matching (see Section 6) on 2 or more days depending on the variability, although the floating car technique could be used on a greater number of days particularly for larger networks.

(g) queue length on the bus lane link at regular intervals.

These measurements may be necessary to :

- determine the optimum length of the bus lane
- assess the modelling accuracy
- assess the occurrence of existing/likely blocking back or traffic diversion conditions, which may indicate whether modelling is worthwhile

(h) other data which may need to be collected include :

- parking characteristics where these effects can be modelled (e.g. in terms of available link width, saturation flow, effect on bus speeds, etc.)
- the stopping time and associated acceleration/ deceleration effects for buses at bus stops, as this effect is not accounted for in the modelling
- walking time for bus passengers, if bus stop location(s) to be significantly altered and waiting time (likely to be insignificantly change)
- bus arrival reliability (e.g. arrival headways)

(ii) Non-Modelling

The main data requirements for non-modelling techniques are those described in items (a), (f), (g) and elements of item (h) as necessary. Additional data may be required according to the method of analysis (see Section 7.5).

(iii) Before and After Data

The usual requirements are as described in items (i), (vi), (vii) and elements of (viii) as necessary.

The modelling methods and procedures adopted in this study are fully described in Sections 7 and 8. The main recommendations applying to TRAFFICQ and CONTRAM are listed below.

With-Flow Bus Lanes

- (i) No setback at junction

Model the lanes containing priority and non-priority traffic as separate links and assign flows accordingly. (This is also applicable to bus lanes approaching pedestrian crossings.)
- (ii) Setback at junction
 - Model the bus lane link as a single link to which all traffic is assigned. Model the effect of the bus lane on non-priority traffic by reducing the number of lanes over the bus lane length (TRAFFICQ) or reducing the storage capacity (CONTRAM). Only change vehicle cruise speeds if the effect of the bus lane is known (unlikely). From measurement of saturation flow construct a saturation flow profile as described in Section 7. Assess whether the bus lane is reducing/will reduce capacity, taking into account existing/likely packing factors. Consider the importance of the simplifications in this approach and the prediction of the time ‘t’ as described in Section 7.1.1 under “SATURATION FLOWS”. If reduction in capacity is predicted, this is reflected by reducing the stop line saturation flow or, for TRAFFICQ, the link entry saturation flows depending on the circumstances. Under these conditions, modelling with TRAFFICQ or CONTRAM may produce significantly biased results when the maximum queue is less than could fit into the setback area, and modelling with BLAMP may be preferred.
 - Different junction layouts are likely to require different methods of approach in the modelling – examples of the methods used at the study sites are described in Appendix D.
 - Where the introduction of a bus lane is being evaluated, calculate the predicted journey time for priority vehicles from the results of the modelling for all traffic, as described in Section 7.1.1. These predictions have a degree of uncertainty to be considered (see Sections 7.1.1 (BUS JOURNEY TIMES”) and 8.4.4), and alternative calculations, or the use of BLAMP may be preferred. (The time associated with bus stops is not considered in the modelling of either the ‘with’ or ‘without’ bus lane situation and has to be included externally as necessary.) Consideration should be given to factors which may reduce/be reducing bus journey time savings from those predicted (e.g. parking violations, high pedal cycle flows, etc.)
 - For roundabouts, the effect of a setback on entry capacity can be estimated by equating the setback to a flare, although there is evidence that this may overestimate the effect of the flare under some circumstances. A better assessment is likely to be obtained by a consideration of the gap acceptance characteristics. This involves the measurement/assessment of the maximum number of vehicles accepting gaps in the circulating traffic under saturated entry conditions to determine whether (and by how much) the bus lane is restricting/will restrict this entry capacity. Any capacity restrictions can be reflected in the models by appropriate specification of the input parameters.

Contra-Flow Bus Lanes

These lanes should be modelled as separate links to those carrying non-priority traffic, traffic flows being assigned accordingly. Journey time predictions for priority vehicles are therefore obtained directly from the model output. Junction setbacks do not occur with contra-flow lanes and the problems outlined in Section b) above do not therefore apply.

General

It is likely that the model will have to be calibrated to some extent to accurately reflect existing conditions. This may be achieved by adjusting the relevant saturation flow(s) within reasonable limits until observed and predicted journey times are not significantly different.

Both TRAFFICQ and CONTRAM give details of aggregated vehicle mileage and flow weighted journey times for the network, and these should be used where more than just the effects on vehicles on the bus lane link are being considered.

8 ECONOMIC EVALUATION

This typically involves a comparison of implementation/removal/ modification costs with first year economic benefits to give a first year rate of return. Longer term evaluation (e.g. as in COBA) is likely to be too uncertain.

The main costs are usually associated with road markings and signs, although others may include surface dressing, junction modifications, kerb re-alignment, etc. Other costs to be considered include maintenance, enforcement and design/evaluation.

The main benefits/disbenefits usually accrue from journey time changes for priority/non-priority traffic and (to a lesser extent) changes in vehicle operating costs. Other quantifiable benefits to be considered may include :Bus passenger walking and/or waiting time reductions.Improvements in bus service reliability.Increased numbers of bus passengers.The calculation of economic benefits is described in Section 9.

9 OTHER EVALUATION CRITERIA

These may include :

- Environmental effects particularly with respect to traffic diversions through environmentally sensitive areas.
- Effects on pedestrians.
- Effects on parking/loading characteristics, loss of access/trade, etc. which cannot be quantified.

A framework of likely benefits/disbenefits may need to be set up and each item subjectively ranked to give an overall appraisal.

10 ACCEPTANCE OF SCHEME

This may be based on an acceptable predicted/measured first year rate of return coupled with a consideration of the other evaluation criteria as described above. Public response to the scheme revealed via consultation is an important consideration for permanent implementation

11 The comparison of vehicle travel times before and after implementation of a scheme requires consideration to be taken of the effects of variations in other conditions which may have occurred, particularly in traffic flows. An analysis of variance is appropriate.

12 FUTURE MONITORING

With bus lanes usually operating at around capacity for significant periods, operational performance is sensitive to variations in network/traffic conditions. Further monitoring/evaluation may therefore be required if such changes occur (e.g. in traffic growth, modal split, traffic signal staging, junction control, etc.)

TPDM Volume 6 Chapter 6 – Speed Limits

6.1 References

1. U.K. Department of Transport, Circular Roads 1/93, Road Traffic Regulation Act 1984: Sections 81-85, Local Speed Limits
2. U.K. Department of Transport, Departmental Advice Note TA 22/81, Vehicle Speed Measurement on All Purpose Roads
3. Road Traffic Ordinance, Cap 374
4. Transport Planning & Design Manual, Volume 3 - Traffic Signs and Road Markings
5. Annual Traffic Census - Traffic and Transport Survey Division, Transport Department
6. Transport Planning & Design Manual, Volume 2 - Highway Design Characteristics

6.2 Introduction

6.2.1 General

- 6.2.1.1 Speed limits are introduced as a means of controlling the speed of traffic along a road. In general, it assumes that higher speeds would lead, or have led, to accidents.
- 6.2.1.2 However for speed limits to be meaningful and have the desired effects, they must be adequately enforceable. Under normal circumstances, this should be achieved by self enforcement, whereby motorists should be able to recognise that the speed limit set is appropriate for the characteristics and conditions of the road and drive accordingly. Enforcement by the police will still be necessary. It is particularly so when a speed limit lower than what would be expected has been imposed, e.g. where surface conditions are not suitable for a higher speed but this fact may not be readily apparent to motorists.
- 6.2.1.3 This Chapter attempts to provide guidelines for determining the appropriate speed limits for roads in the Territory. However such advice is related to the general situation only and particular circumstances of a road must be taken into account before fixing its appropriate speed limit.
- 6.2.1.4 When determining the appropriate speed limit for a road it is important to take account of the speed limit or limits applying to other sections of the route that the road forms part of. Frequent changes of speed limits should be avoided and as far as possible the same speed limit should apply throughout a route. For toll plaza area, the speed limit should be the same as one of the connecting roads.

6.3 Legislation

6.3.1 Ordinances and Regulations

- 6.3.1.1 The Road Traffic Ordinance, Cap 374, provides the necessary legislation on the speed limits that can be imposed on public roads in the Territory.
- 6.3.1.2 Clause 40 of this Ordinance imposes a speed limit of 50 km/h on all roads, but permits the Commissioner for Transport by notice in the Gazette to vary speed limits for particular roads and if thought appropriate to introduce variable speed limits.
- 6.3.1.3 Clause 40 also imposes a maximum speed limit of 70 km/h for medium goods vehicles, heavy goods vehicles and buses. Hence even for roads that have a general speed limit of 80 km/h or above, these classes of vehicles can only be driven at not more than 70 km/h.
- 6.3.1.4 The Road Tunnels (Government) Ordinance and Regulations do allow a different procedure to be adopted for the imposition of speed limits in Tunnel Areas. Even though gazette notices are not strictly required, it is recommended that for compatibility with roads outside these areas gazette notices shall be issued in accordance with Clause 40 of the Road Traffic Ordinance, Cap 374.
- 6.3.1.5 The Road Tunnels (Government) Regulations, Tsing Ma Control Area (General) Regulation, Eastern Harbour Crossing Road Tunnel By-laws, Tate's Cairn Tunnel By-laws, Tai Lam Tunnel and Yuen Long Approach Road By-law, and Western Harbour Crossing By-law also impose a minimum speed of 25 km/h in Tunnel Areas. However such minimum speeds cannot, under the present legislation, be applied to other roads.
- 6.3.1.6 Appropriate signs to be used for speed limits should be in accordance with the Road Traffic (Traffic Control) Regulations, First Schedule, and advice on signing arrangements is referred to in subsequent sections of this Chapter, with more detailed advice being given in Chapter 2 of Volume 3.

6.3.2 Gazette Notices

- 6.3.2.1 The gazette notices should as far as possible use standard terminology and be similar in content for all Regions.
- 6.3.2.2 It is important that the location of the start and finish points of any particular speed limit referred to in the notice accord closely with those indicated by the traffic signs to avoid any enforcement problems. Hence, it is important to ensure that descriptions in the gazette and the actual positions of the traffic signs shall not vary by more than 10m.
- 6.3.2.3 If variable speed limits are to be imposed on a road for any reasons, say, change in climatic conditions or for maintenance purposes, then the gazette notice must state the various speed values that may be used along that road. In this respect the appropriate speed values to be chosen will depend on the particular circumstances of the route.
- 6.3.2.4 Where a temporary speed limit is to be imposed on a road, and the road has not been gazetted as having variable speed limits, gazette notices as if the speed limit was a permanent one will need to be published as there are no special procedures for imposing temporary speed limits. Without the gazette notice the temporary speed limit shall not be enforceable. A press release should also be issued explaining that the speed limit is temporary and will be rescinded as soon as the particular works are completed.

6.4 The Use of Speed Limits

6.4.1 General

- 6.4.1.1 Speed limits are used as a means of controlling the speed of traffic to a level which is considered appropriate for that road under the generally prevailing conditions.
- 6.4.1.2 It must be remembered that speed limits are not an indication of the speed that vehicles must be driven at, but the speed that must not be exceeded at any time.
- 6.4.1.3 Speed limits are not intended to imply that the particular speed indicated can be driven at all times, under all conditions, and by all types of vehicles. Motorists have an obligation themselves to drive with care and make necessary allowances in respect of their vehicle, their ability, traffic conditions, climatic conditions, and any constraints such as bends and surface characteristics of the road.
- 6.4.1.4 Variable speed limits should only be used for Tunnel Areas, Trunk Roads, and Primary Distributor Roads having no frontage access. Their use may be appropriate along these routes where it is considered advantageous that in the event of an incident, e.g. an accident, a change in climatic conditions or for road maintenance purposes, a speed limit lower than that normally prevailing could be imposed. Consideration on the frequency of such use will be required as there will be little benefits obtainable by installing equipment which has only very limited use.
- 6.4.1.5 During the construction of certain types of road works it may be appropriate to introduce a temporary speed limit less than that normally prevailing to control the speeds of vehicles passing through the site. However, such a scheme should be carefully examined to ensure that unnecessary delay or inconvenience would not be caused. Speed limits less than 50 km/h will not normally be appropriate, unless it is considered vehicle manoeuvring at higher speeds are likely to be dangerous with the possibility of vehicles encroaching onto other traffic lanes. In these situations a 30 km/h speed limit may be considered.

6.4.2 Range of Speed Limits

- 6.4.2.1 It has been found elsewhere that lower speeds do result in fewer and less serious injury accidents. However, simply imposing a low speed limit does not automatically ensure that travelling speeds are reduced and the overall accident rate is correspondingly brought down. For example, in urban areas in the Territory actual travelling speeds are often less than the imposed speed limit but accidents still occur and, conversely, on some of the high capacity roads travelling speeds well in excess of the posted speed limits are not uncommon, but generally these roads have a lower accident rate than other roads for a variety of reasons.
- 6.4.2.2 Imposing artificially low speed limits along a route will also require considerable enforcement. Otherwise, the speed limit and the authorities who imposed it will be brought into disrepute.

- 6.4.2.3 Although this can yet to be verified for local conditions, experience in other countries indicate that raising the speed limit in line with observed driving practice will not encourage motorists to drive faster or necessarily result in an increase in accidents.
- 6.4.2.4 Unlike the legislation of many other countries, the Road Traffic Ordinance does not impose a maximum speed limit, other than in respect of Medium Goods Vehicles, Heavy Goods Vehicles and Buses. Theoretically, it is possible to choose any speed limit for roads where a speed limit higher than 50 km/h could be imposed. However in practice, when making such a choice it is necessary to minimise the number of speed category and to take into account driver behaviour and discipline, the general level of vehicle performance and maintenance, road surface characteristics, and other related factors. Based on these criteria, the highest standard speed limit shall be set at 100 km/h though under very exceptional situation, 110 km/h may be used.
- 6.4.2.5 Generally, speed limits lower than 50 km/h are not recommended for public roads, as they require a higher level of enforcement to ensure compliance, and it is doubtful that the lower speed limit imposed will contribute significantly to accident prevention. For roads which may be substandard in terms of geometric design, such as width, alignment and gradient, relevant warning signs shall be installed advising motorists that a slower speed is required instead of imposing speed limits less than 50 km/h. If for any reason a speed limit lower than 50 km/h is required, 30 km/h should be the only value used.
- 6.4.2.6 For uniformity, the standard speed limit values, namely 50 km/h, 70 km/h, 80 km/h and 100 km/h should be adopted. Values such as 55 km/h, 60 km/h, 65 km/h etc. should not be used. A speed value lower than 50 km/h should not generally be considered as a variable speed limit, except perhaps in Tunnel Areas where under certain conditions it may be beneficial to be able to impose a speed limit of 30 km/h. To minimise the number of different speed limits, 60 km/h and 90 km/h should not be used.
- 6.4.2.7 Safe speeds to indicate that a particular bend should be negotiated at a speed less than the posted limit shall not be used. Instead, signing in accordance with paragraph 2.3.3.19, Chapter 2 of Volume 3 shall be adopted depending on the severity of the bend.

6.5 Criteria for Speed Limits

6.5.1 Standard Speed Limits for Existing Roads

6.5.1.1 While there may be particular circumstances arising when roads need to be considered individually, a standard speed limit can usually be assigned in accordance with the general characteristics of the various road types, as previously defined in Section 3.2 of Volume 2. The appropriate standard speed limits for existing roads are given in Table 6.5.1.1.

Table 6.5.1.1
Standard Speed Limits for Existing Roads According to Road Characteristics

<u>Road Type</u>	<u>Characteristics</u>	<u>Standard Speed Limit</u>
Rural and Urban Trunk Roads	Dual carriageway, grade separated interchanges, no frontage access, pedestrians/cyclists prohibited Design speed > 80 km/h	80/100 km/h (110 km/h may be used under very exceptional circumstances)
Rural and Urban Trunk Roads	Dual carriageway, some at grade junctions, no frontage access Design speed > 70 km/h	70 km/h
Primary Distributor Roads	Dual carriageway, no frontage access, grade separated junctions, pedestrians and cyclists prohibited Design speed > 80 km/h	70/80 km/h
Primary Distributor Roads	Dual carriageway, at grade junctions Design speed > 70 km/h	70 km/h
Primary Distributor Roads	Single carriageway two way road, frontage access, medium to high pedestrian volumes, zebra crossings Design speed > 70 km/h	50 km/h
Rural Road Type	4 or more lanes single carriageway two way road, some frontage access Design speed > 50 km/h	50/70 km/h
All Other Roads	Dual or single carriageway roads with frontage access, at grade junctions, zebra crossing, loading/unloading activities, or street parking	50 km/h

6.5.1.2 The design speed of a road as referred to in Table 6.5.1.1 is that in accordance with section 3.3.2 of Chapter 3 of Volume 2 and relates to the overall length of but not particular elements along that road or route under consideration.

6.5.2 Speed Limits for New Roads

6.5.2.1 To avoid too many speed limits to follow, the 50-80-100 km/h three tier speed limit structure should be used for all future roads or major road improvements. For existing roads not falling within the three tier speed limit structure, their speed limits should be reviewed and improvement works should be carried out, if necessary and feasible. Table 6.5.2.1 should generally be used to determine an appropriate speed limit for the particular road according to its road type unless there are reasons that a different speed limit to that indicated in the table is required.

Table 6.5.2.1
Standard Speed Limits for New Roads According to Road Characteristics

<u>Road Type</u>	<u>Characteristics</u>	<u>Standard Speed Limit</u>
Expressway, Rural and Urban Trunk Roads	Dual carriageway, grade separated interchanges, no frontage access, pedestrians/cyclists prohibited Design speed \geq 80 km/h	80/100 km/h
Primary Distributor Roads	Dual carriageway, at grade junctions Design speed \geq 50 km/h	50/80 km/h
Primary Distributor Roads	Single carriageway two way road, frontage access, medium to high pedestrian volumes, zebra crossings Design speed = 50 km/h	50 km/h
Urban and Rural Roads	Dual carriageway, at grade junctions and some frontage access Design speed \geq 50 km/h	50 km/h
Urban and Rural Roads	Single carriageway two way road, some frontage access, and at grade junctions Design speed = 50 km/h	50 km/h

6.5.2.2 For new road projects already under design or construction stages, attempt should be made to revise the design or construction works to fit the 3-tier speed limit structure as far as possible. If this will adversely affect the project programme or provision, the Chief Engineer/Strategic Roads or the relevant Chief Traffic Engineer/Region of TD shall determine the appropriate speed limit of the new road, in consultation with Chief Engineer/Road Safety and Standards and the works department.

6.5.2.3 Where it is considered that a higher speed limit than 50 km/h may be appropriate for a new road the following points should be taken into account :

- (i) the use of speed limits greater than 80 km/h should not be considered without prior consultation with all concerned parties, including but not limited to Research and Development Division of Highways Department with respect to the type and requirements of road surfacing to be used and the Hong Kong Police Force;
- (ii) the geometric design standards of the road should be equivalent to the road type for the higher standard speed limit under consideration;
- (iii) the road section should be at least 1 km in length or is contiguous with a road having the higher speed limit;
- (iv) a stopping restriction for 24 hours should be considered if necessary;
- (v) the road surface characteristics should be adequate for the speed limit proposed.

6.5.2.4 Even though the design standard of the road under consideration may be below that desirable it may be appropriate to consider imposing a higher speed limit than that indicated in Table 6.5.2.1 when the road in question is less than 1 km in length but is contiguous with roads having the higher speed limit in order to avoid frequent changes of speed limits along the route. However it will be necessary to ensure that the imposition of a higher speed limit would not have a detrimental effect on pedestrians.

6.5.2.5 At new roundabouts the appropriate speed limit through the roundabout is that applying to the majority of approach roads, but in the absence of a majority the lowermost speed limit should be adopted.

6.5.3 Speed Limits Less Than 50 km/h

6.5.3.1 The introduction of speed limits less than the standard 50 km/h is not generally recommended on public roads.

6.5.3.2

Justification for a permanent speed limit of 30 km/h will need to be considered on an individual basis having regard to the particular circumstances, including the road environment, design speed and accident rate, of the road under consideration. However, narrowness of the road, and/or the existence of isolated hazards along it are not sufficient reasons for the imposition of such a speed limit.

6.6 Review of Existing Speed Limits

6.6.1 Review Periods

6.6.1.1 A review of speed limits on all roads should be carried out at regular intervals.

6.6.1.2 The frequency for such reviews will depend to a large extent on the available staff resources, but should make reference to the following guidelines :

- (i) Trunk Roads, 12 - 24 months after opening and then every 36 months.
- (ii) Primary Distributor Roads, 12 - 24 months after opening and then every 48 months.
- (iii) Rural Roads, 12 - 24 months after opening and then every 60 months.
- (iv) All other roads, not greater than 120 months.

6.6.2 Review Methodology

6.6.2.1 It is not necessary to have the same degree of examination for all roads. For most roads, if the speed limits accord with those given in Table 6.5.1.1 then it can be assumed that changing the speed limit is not required, particularly if there has not been any demand to change the speed limit and the accident rate on the particular road is not excessive. If design speeds are not available for the road or section in question, such values can be determined by comparison of the actual vertical and horizontal alignment, superelevation and sight distances with the given criteria in Volume 2, Chapter 3.

6.6.2.2 Where the speed limit of the road is not in accordance with Table 6.5.1.1, or there are indications that the posted limit should be revised it will be necessary to examine in greater detail the road or route in question.

6.6.2.3 For investigating the raising of speed limit, detailed examination according to the flow chart diagram 6.6.2.1, should take account of the following :

- (i) Length of road or section of road
Where the length of road or section under investigation is less than 1km, and not contiguous to another road having a higher speed limit it will normally be appropriate to retain the existing speed limit.
- (ii) Accident Rate
Where the personal injury accidents per million vehicle-kilometres for the road or section of road under consideration is greater than the average accident rate of the road type, the existing speed limit should be retained, unless there are other considerations which strongly indicate that the retention of the speed limit is not appropriate. For calculation of the accident rate Section 6.7.2 should be referred to. Road Safety and Standards Division of Transport Department should be consulted for the latest average accident rate.
- (iii) 85th percentile Speed
Where the 85th percentile speed is less than the threshold value corresponding to the imposed speed limit shown in Table 6.6.2.1 the existing speed limit should normally be retained. If the 85th percentile speed is greater than that threshold value this may be used as a justification to increase the speed limit provided that other considerations as described in this section also indicate that an increase in the speed limit is appropriate.
- (iv) Road Surface Characteristics
When it is considered that a speed limit on a road should be increased, the road surface requirement should be carefully considered. Refer to Road Note 5 and paragraphs 6.3.1.4 to 6.3.1.7 of TPDM Volume 2 Chapter 6 for details. If there is doubt, the Research and Development Division of Highways Department should be consulted.

Table 6.6.2.1
85th Percentile Threshold Values For Raising Speed Limits

<u>Existing speed limit(km/h)</u>	<u>85th percentile speed threshold value below which existing speed limit should be retained(km/h)</u>
50	63
70	80
80	93
100	110

DIAGRAM 6.6.2.1 : FLOW CHART FOR RAISING SPEED LIMIT REVIEW

*Road Safety and Standards Division of Transport Department should be consulted for the latest figure

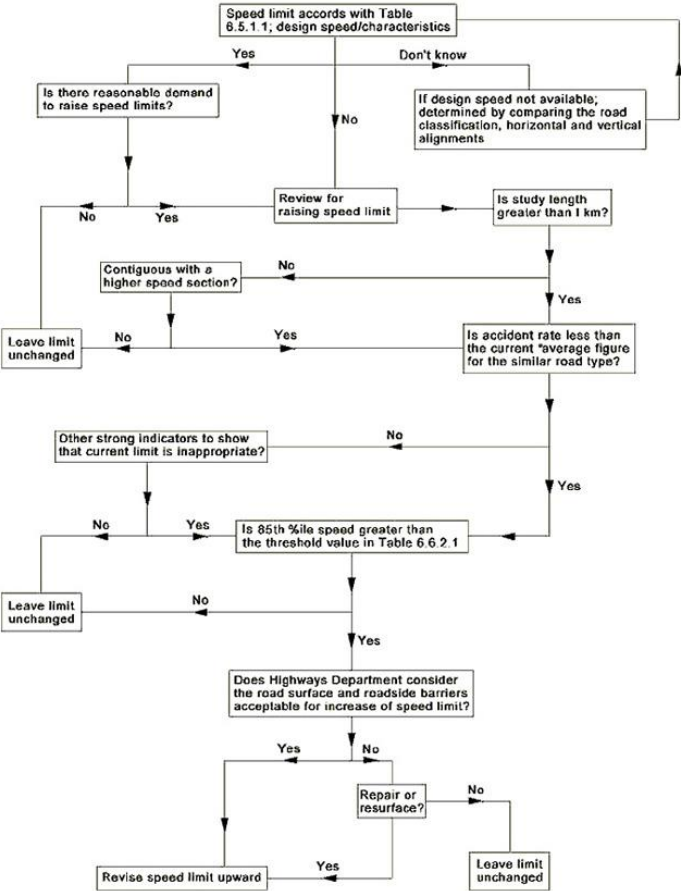

6.6.2.4 When investigating the lowering of speed limit, detailed examination in accordance with the flow chart Diagram 6.6.2.2 the review should include consideration of the following :

- (i) Length of road or section of road
Where the length of road or section of road under investigation is less than 1km and is not contiguous with a road having the lower speed limit the existing speed limit should normally be retained.<
- (ii) Accident Rate
Where the personal injury accidents per million vehicle-kilometres for the road or section of road under consideration is less than the average accident rate of the road type the existing speed limit should normally be retained. Where the personal injury accidents per million vehicle-kilometres is greater than the average rate consideration may be given to lowering the speed limit but other measures should also be investigated; e.g. erection of warning signs, before deciding whether reduction of the speed limit is the most appropriate course of action.
- (iii) 85th percentile Speed
Where the 85th percentile speed is greater than the existing speed limit, it is doubtful that a lower speed limit will be properly observed without a higher degree of enforcement. Therefore, as a general rule, it is not recommended that speed limits should be lowered unless for special reasons or the 85th percentile value is equal to or below the value of the existing speed limit.
- (iv) Road Surface Characteristics
Road surface characteristics, other than in respect of temporary speed limits required to be imposed as a result of road works, should not normally influence the lowering of a speed limit. Whenever necessary, remedial measures should be undertaken to improve the surface to a standard appropriate for the proposed speed limit.
- (v) Other Characteristics
In considering whether a speed limit should be lowered it should also be examined whether the general characteristics of the road or section of road has changed since the original introduction of the speed limit. It should be examined whether frontage development has increased or changed resulting in greater pedestrian activity, an increased number of run-ins, or increased loading/unloading activities. Similarly examination should be made to see if there has been any changes in traffic flow or composition. If there has been no significant changes in the general characteristics of the road then the existing speed limit should be retained.

DIAGRAM 6.6.2.2 : FLOW CHART FOR LOWERING SPEED LIMIT REVIEW

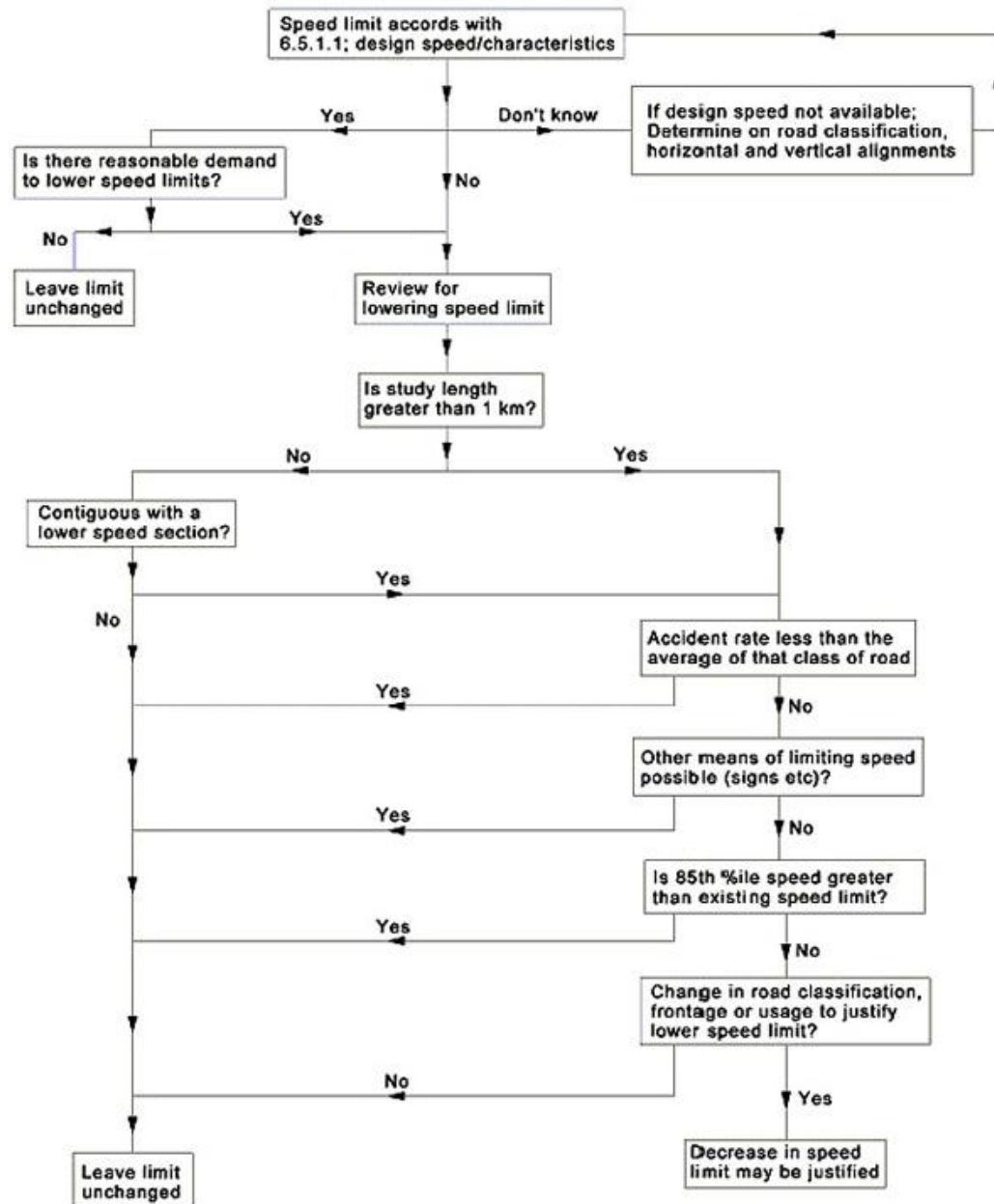

6.6.2.5

Isolated hazards such as a single road junction or a sharp bend, should not be taken as sole reasons for not introducing a higher speed limit or lowering an existing speed limit, as other measures such as warning signs, improving the road superelevation if necessary, can be used to give adequate warning or improve these situations. Similarly, speed limits should not be used in respect of conditions that only arise for short periods of the day, e.g. specific activities outside schools or industrial premises for only particular periods of the day. Warning signs, improvements to pedestrian facilities or street lighting would cater for these factors better than a general imposition of a special speed limit.

6.6.2.6 Notwithstanding the advice given in paragraph 6.6.2.4, it is sometimes necessary to consider lowering a 70 km/h speed limit to 50 km/h in the vicinity of minor developments such as villages. While every case will need to be considered on its own merit the following guidelines may be used to determine where it might be appropriate to lower the speed limit :

- (i) While it is desirable that the section over which the speed limit is lowered should be at least 1km, this may not always be appropriate or possible, but the length should never be less than 300m.
- (ii) The frontage length of the minor development should be 100m or more.
- (iii) The existing 85th percentile speed in the immediate vicinity of the development should not exceed 70 km/h.
- (iv) The speed limit should be able to be adequately enforced.

6.6.2.7 Environmental and other factors which may suggest a 50 km/h speed limit is appropriate in the vicinity of a minor development should also be taken into account, but these should be considered as further supportive evidence in addition to general compliance with paragraph 6.6.2.6, and not the sole reason for reducing the speed limit.

6.6.2.8 As mentioned in paragraph 6.5.2.5 the appropriate speed limit through a roundabout is that applying to the majority of approach roads or where there is no majority the lowermost speed limit should be adopted. Therefore when reviewing speed limits, or when proposing changes to speed limits on one or more approach roads to the roundabout, it should be checked whether the speed limit applying to the roundabout would need to be changed in accordance with this rule.

6.7 Related Matters

6.7.1 Speed Limit and Warning Signs

6.7.1.1 Advice on appropriate signs for speed limits together with spacing and use of repeater signs is given in Volume 3, Chapter 2, sections 2.3.2.78 to 2.3.2.81 and should be followed.

6.7.1.2 “Safe Speed” signs must not be used but instead appropriate “bend” warning signs in accordance with Volume 3, Chapter 2 sections 2.4.2.12 and 2.4.2.13 should be erected if considered necessary.

6.7.1.3 For other hazards advice on appropriate warning signs and their use is given in Volume 3, Chapter 2.

6.7.1.4 Signs to warn of the lowering of speed limit ahead, TS 570 to TS 573, should be erected under the following conditions :

- (i) It shall only be erected on expressways and major roads at locations where there is a reduction in speed limit by 20 km/h or more.
- (ii) It may be used where it is not obvious to motorists judging from the highway environment that a lower speed limit is in force ahead, e.g. there is no change in physical layout of the main road alignment, no change from rural to urban road type etc. It should not be used to warn of the lowering of speed limits on exits of slip roads.
- (iii) At times road works may cause deterioration of the highway environment. For instance complexity of road layout may reduce visibility and reduce the conspicuity of the lower speed limit signs ahead. In such cases, the proposed advisory signs may be used to forewarn motorists of the lowering of speed limits.
- (iv) The proposed traffic signs should be erected on both sides of the carriageway in advance of the lower speed limit traffic signs. The supplementary plate should bear the distance of either 100m or 200m, according to site situation. However the exact location of the proposed traffic signs can be adjusted to suit site conditions.
- (v) Where there is variable speed limit sign, the proposed advisory signs should not be used.

6.7.2 Accident Rates

6.7.2.1 The personal injury accident rate per million vehicle kilometres should be calculated from the following :

$$\text{Accident rate} = \frac{A * 10^6}{T * L}$$

Where

A = Recorded no. of personal injury accidents over the latest 12 month period

T = The annual traffic flow

L = Length of section in kilometres

6.7.2.2 The recorded number of personal injury accidents over the latest 12-month period for the section of road under investigation, may be obtained from the Road Safety & Standards Division, Transport Department.

6.7.2.3 The annual traffic flow may be calculated by:

- (i) if the road or section of road includes or is near to a coverage (B) station for the Annual Traffic Census, multiplying the Annual Average Daily Traffic flow (AADT) for that station by 365; or
- (ii) if the road or section of road does not include a coverage (B) station, then it will be necessary to carry out a 16 hr. weekday count. To convert this to the annual traffic flow, an appropriate counting station on a road having similar characteristics to the road or section of road under investigation should be chosen and the proportions for that counting station should be used to convert the 16 hr. flow to 24 hr. flow, and 24 hr. flow to the AADT Flow. The AADT Flow should be multiplied by 365 to obtain the annual traffic flow.

TPDM Volume 6 Chapter 7 – Environmental Considerations

7.1 References

1. *Air Pollution Control Ordinance, Cap. 311*
2. *Noise Control Ordinance, Cap. 400*
3. *Road Traffic (Construction and Maintenance of Vehicles) Regulations* 1983
4. Planning Department, *"Hong Kong Planning Standards and Guidelines Chapter 9 - Environment"*
5. Department of the Environment, *"The Environmental Evaluation of Transport Plans"*, Research Report 8, 1976
6. Department of the Environment Department of Transport, *"Roads and the environment"*, Supplementary Report 536, Transport and Road Research Laboratory, UK 1980
7. Hong Kong Government Port and Airport Development Strategy, *"Air Quality Studies: Emissions and Baseline Concentration Calculations"* Technical Paper 13' Mott Hay & Anderson Hong Kong Ltd. et al
8. Hong Kong Government Port and Airport Development Strategy, *"Air Quality Studies: Results of Coarse Screening"* Technical Paper 26, Mott Hay & Anderson Hong Kong Ltd. et al
9. Hong Kong Government Port and Airport Development Strategy, *"Air Quality Studies: Second Stage"* Technical Paper 38, Mott Hay & Anderson Hong Kong Ltd. et al
10. The Institution of Transportation Engineers, *"Environmental Considerations in Traffic Engineering"*, Transport and Traffic Engineering Handbook
11. Institution of Highways and Transportation and Department of Transport, *"Roads and Traffic in Urban Areas"* 1987
12. Highways Department Western District Traffic Study, *"Preliminary Environmental Assessment of New Links"*, Working Paper No. 6, Peter Y.S. Pun & Associates and the MYA Consultancy, 1987
13. *"An Approach to the Evaluation of Transportation Plans"*, Regional Science Research Institute, GPO Box 8776, Philadelphia, Pennsylvania 19101, USA
14. Department of Transport, *"Calculation of Road Traffic Noise"*, Her Majesty's Stationery Office, UK 1988
15. Wilbur Smith Associates Limited, *"Third Comprehensive Transport Study&"*, October 1999
16. Highways Department, *Structures Design Manual for Highways and Railways*, 1997
17. Environmental Protection Department, *"Technical Memorandum on Environmental Impact Assessment Process"* under EIAO
18. Planning, Environment and Lands Bureau, *"Clean Air for Hong Kong"*
19. Highways Department and Environmental Protection Department, *Noise Mitigation Works for Public Roads*, August, 1996

20. Environmental Protection Department, *Practice Note for Professional Persons on Control Air Pollution in Semi-Confined Public Transport Interchange (PN)1/98*

7.2 Introduction

- 7.2.1 All highway improvement and traffic management schemes should attempt to make a positive contribution towards improving the environment whenever possible. However, improvements for the travelling public may often be incompatible with the needs of pedestrians and the occupants of properties along the highway.
- 7.2.2 Hence, an appropriate balance will need to be achieved between improving the environment in an area and improving accessibility for vehicles.
- 7.2.3 This Chapter attempts to provide guidance on the environmental consequences of traffic as it affects noise, air pollution and visual intrusion and what abatement measures could be undertaken to minimise any adverse environmental effects. There could be other environmental factors such as ground vibration, waste pollution etc. that are not included, as they may be surrogates of the factors considered or may be associated directly with highway or building design.
- 7.2.4 Environmental considerations should be introduced at the planning and design stages where alternative transport systems and management measures are evaluated. It should be included in the evaluation process together with the operational, economic and other aspects.

7.3 Air Pollution

7.3.1 General

- 7.3.1.1 Air pollution is defined as the presence of foreign matter (particulates and gases) in the air at levels of concentration which could affect man's well-being or interfere with the use and enjoyment of the environment.
- 7.3.1.2 Air pollution can occur as a result of combustion of fossil fuel in industry and transportation systems causing appreciable levels of sulphur dioxide and other gaseous products together with soot and ashes.
- 7.3.1.3 Air pollution can also occur from the evaporation of fuel from storage tanks, and losses from the carburettor and crankcase of individual vehicles when in operation. Dust produced from the vehicle movements, gradual wearing away of rubber tyres, brake-linings and clutch plates of individual vehicles also causes pollution.

7.3.2 Composition and Sources of Major Pollution

- 7.3.2.1 During the combustion of petrol in an internal combustion engine, it is difficult to achieve complete oxidation so that carbon monoxide is formed in considerable quantities.
- 7.3.2.2 Carbon monoxide is a poisonous gas that reduces the oxygen carrying capacity of red blood cells. A high concentration over a short period of exposure can be fatal; a small amount can cause dizziness, headaches, fatigue and slow driving reactions. Moderate concentrations could often exist in road tunnels, garages and heavy traffic streams.
- 7.3.2.3 Oxides of nitrogen are formed from nitrogen and oxygen when fuel is burned. Nitric oxide (NO) has the potential to oxidize to nitrogen dioxide (NO₂). At high concentrations NO₂ acts as a pulmonary irritant and is a precursor of smog (combination of smoke and fog).
- 7.3.2.4 Sulphur oxides are pollutants emitted mainly from factories and power stations due to burning of coal or oil containing sulphur. Motor vehicles, however, are also the sources of sulphur oxides. When mixed with other pollutants and with moisture, it irritates the eyes, nose and throat, damages the lungs, kills plants, rusts metals, and reduces visibility.
- 7.3.2.5 Particulates such as smoke, fly ash, dust, fumes etc. are solid and liquid matter in air. They may settle to the ground or remain suspended. They soil clothes, dirty window sills, scatter light, and carry poisonous gases into the lungs. They emanate from motor vehicles, smelters, construction sites etc.
- 7.3.2.6 The smoke emitted by vehicles consists of fine particles of carbon resulting from the incomplete combustion of fuel. The problem is usually associated with diesel engine vehicles. Because smoke is clearly visible its emission attracts most complaint from the public, who associate it with other pollutants.
- 7.3.2.7 Starting from 1 April 1999, all leaded petrol has been banned.

7.3.3 The Transport System and Air Pollution

- 7.3.3.1 Sources of air pollution may be stationary and/or mobile. Emissions from power plants, waste incinerators, industrial, commercial and domestic sources are classified as stationary sources while those from transport systems (road, rail, air and water) are referred to as mobile sources.
- 7.3.3.2 Electric powered transport systems produce minimal air pollution in the area of operation. However, they cause pollution indirectly at the source of power generation through the use of coal or oil fired furnaces to generate the energy required to propel the electric vehicles used in a transport system.

- 7.3.3.3 Air quality studies conducted during the *Port and Airport Development Strategy (PADS) Study* indicate that the major sources of air pollution in the Territory are power plants and road transport. The air pollution caused by aircraft and waterborne transport, excluding ships, is negligible. Hence, the guidance provided in this chapter relates primarily to road transport systems.
- 7.3.3.4 Pollution levels from road traffic vary considerably depending on environmental performance of vehicles and their travelling distance, time of day, and meteorological conditions. Speed is a factor in exhaust emissions. Hence, stop-start operations experienced in an urban area have a dramatic effect on hydrocarbon and carbon monoxide emissions from motor vehicles.
- 7.3.3.5 Although petrol engines and diesel engines both give rise to similar products in their exhausts, the relative proportions could be very different. Tables 7.3.3.1 and 7.3.3.2 indicate the emissions in the Territory in 1997 as obtained from '*Clean Air for Hong Kong*'. On the other hand, the vehicle emission factors obtained from '*Third Comprehensive Transport Study - Strategic Environmental Assessment Technical Report*' are shown in Table 7.3.3.3.
- 7.3.3.6 The emission factors in Table 7.3.3.3 are an update of those previously adopted in the Territory.
- 7.3.3.7 Unlike in other countries, the majority of emissions from vehicles in the Territory originate from diesel fuelled engines as seen in Table 7.3.3.2. Only a minor proportion of the emissions is from petrol engine vehicles. Hence, emission reduction techniques suitable elsewhere may not necessarily be effective in the Territory.
- 7.3.3.8 Much progress has been made towards developing cleaner working petrol engines and the use of cleaner petrol. Some technologies such as diesel catalyst for buses and low cost traps for taxis are also available for reducing emissions from diesel engines. Nevertheless, reductions in emissions from diesel engines can mostly be achieved through control on the quality of diesel fuel and proper maintenance that will improve engine performance and fuel consumption. To alleviate the pollution problem caused by diesel engines, the government implemented a trial scheme for liquefied petroleum gas (LPG) taxis with a view to charting out a strategy to encourage all taxi operators to switch to LPG by phases starting from end 2000. Particulate screening equipment is also mandatory to be installed in some diesel engine vehicles. Cleaner diesel fuel, i.e. diesel with low sulphur content/city diesel has been used by all diesel vehicles and buses. Furthermore, engines of Euro II standard have been introduced since 2001.
- 7.3.3.9 Vehicle age is a factor in the level of pollution primarily because of the innovations in anti-pollution equipment in newer vehicles to meet more stringent standards, rather than the lack of maintenance per se.
- 7.3.3.10 As emissions from mobile sources in the Territory are primarily from diesel engine vehicles, more emphasis should therefore be paid to ensure that the vehicle fleet is maintained and operated in such manner as to optimise engine performance.

Table 7.3.3.1
Emissions in Hong Kong - 1997

<u>Emission Sources</u>	<u>SO₂</u>	<u>NO_x</u>	<u>Particulate Matters</u>
Power Station	65.43%	45.36%	32.54%
Cement Plant	0.10%	1.63%	1.27%
Marine Vessel	6.23%	10.42%	9.07%
Aircraft	0.51%	3.60%	0.29%
Vehicle	7.01%	33.12%	51.95%
Fuel Combustion	20.68%	5.85%	4.62%
Incinerator	0.03%	0.02%	0.25%

Note :

Particulate Matters include Total Suspended Particulates (TSP) and Respirable Suspended Particulates (RSP)

Table 7.3.3.2
Emissions in Urban Area from Vehicles - 1997

<u>Emission Sources</u>	<u>Hydrocarbon</u>	<u>Oxide of Nitrogen</u>	<u>RSP</u>
Petrol Private Cars	28.4%	22.1%	1.7%
Other Petrol Vehicles	29.1%	2.2%	0.3%
Taxis	5.9%	11.5%	25.7%
Public Light Buses	1.6%	2.3%	4.0%
Private Light Buses	0.4%	0.7%	1.1%
Diesel Light Goods Vehicles	7.7%	12.7%	24.8%
Diesel Private Cars	0.2%	0.3%	0.7%
Franchised Buses	6.8%	16.0%	10.6%
Private Buses	0.8%	1.9%	1.2%
Medium Goods Vehicles	18.5%	28.8%	28.9%
Heavy Goods Vehicles	0.6%	1.5%	1.0%

Source :

Clean Air for Hong Kong

Table 7.3.3.3
Fleet Average Vehicle Emission Factors (gkm⁻¹)

Year		M/C	P/C	Taxi	PV	PLB	LGV	HGV	NFB	FBSD	FBDD
Fuel		P	P	D→LPG	D	D	D	D	D	D	D
1997	NO _x	0.56	1.76	1.55	2.37	2.27	1.78	7.76	12.66	12.08	12.06
	VOC	11.93	1.01	0.36	0.74	0.72	0.70	2.22	2.39	2.33	2.33
	RSP	0.03	0.04	0.65	0.74	0.72	0.54	1.12	1.58	1.49	1.49
2001	NO _x	0.55	1.22	1.51	2.17	2.05	1.62	6.74	10.72	10.73	10.73
	VOC	11.62	0.66	0.29	0.63	0.60	0.62	2.05	2.19	2.21	2.21
	RSP	0.03	0.04	0.15	0.49	0.42	0.34	1.16	1.20	1.22	1.22
2001	NO _x	0.55	1.22	1.51	2.17	2.05	1.62	6.74	10.72	10.73	10.73
	VOC	11.62	0.66	0.29	0.63	0.60	0.62	2.05	2.19	2.21	2.21
	RSP	0.03	0.04	0.15	0.49	0.42	0.34	1.16	1.20	1.22	1.22
2006	NO _x	0.48	0.83	0.84	1.67	1.70	1.39	5.07	7.15	9.26	9.26
	VOC	8.28	0.43	0.43	0.48	0.48	0.55	1.64	1.52	1.98	1.98
	RSP	0.03	0.03	0.01	0.22	0.18	0.15	0.81	0.74	1.01	1.01
2011	NO _x	0.37	0.71	0.73	1.53	1.54	1.23	3.84	5.54	6.80	8.80
	VOC	4.77	0.41	0.40	0.45	0.45	0.52	1.32	1.27	1.53	1.53
	RSP	0.03	0.03	0.01	0.16	0.12	0.11	0.53	0.50	0.89	0.59
2016	NO _x	0.37	0.71	0.73	1.53	1.54	1.23	3.84	5.54	6.80	8.80
	VOC	4.77	0.41	0.40	0.45	0.45	0.52	1.32	1.27	1.53	1.53
	RSP	0.03	0.03	0.01	0.16	0.12	0.11	0.53	0.50	0.69	0.69

NOTES :

M/C = Motorcycle

P/C = Private Car

PV = Passenger Van

PLB = Public Light Bus

LGV = Light Goods Vehicle

HGV = Heavy Goods Vehicle

NFB = Non-Franchised Bus

FBSD = Franchised Bus Single Deck

FBDD = Franchised Bus Double Deck

NO_x = Oxides of Nitrogen

VOC = Volatile Organic Compounds

RSP = Respirable Suspended Particulates

LPG = Liquefied Petroleum Gas

D = Diesel

P = Petrol

Assumptions :

- LPG taxi starts from 2001, 100% by end of 2005

- Euro III emission standards start from 2001

Due to lack of 2016 emission factors, 2011 emission factors are assumed to prevail

Source : CTS3 - SEA Technical Report

7.3.4 Estimation of Future Emission from Mobile Sources

7.3.4.1 Air pollution predictions for a future design year can be derived by the application of one of several available Gaussian plume atmosphere dispersion models for line sources. The use of these models should be agreed with the Environmental Protection Department.

7.3.4.2 Dispersion calculations for local air quality assessment from emissions at a low level from traffic tail pipe emissions have been performed in the Territory using the US-EPA California Line Source Dispersion Model (CALCINE-4).

- 7.3.4.3 The model calculates concentrations of NO, NO₂ and particulates at specified receptors. Concentrations of the gaseous pollutants, namely NO and NO₂ are given in ppm which can be converted to µg/m³ using appropriate factors. Particulate concentrations are given in µg/m³. Concentration of other pollutants can also be calculated by the same model using appropriate proportion of sources and assumption on conversion.
- 7.3.4.4 The estimated future traffic flow and composition by vehicle type on each link in the road network is derived from the transport modeling procedure used, and serves as an input into the air pollution dispersion program.
- 7.3.4.5 For air quality, unfavourable weather conditions are low wind speeds, low mixing heights (at medium range from pollution sources) and high atmospheric stability (at short range).
- 7.3.4.6 The prevailing wind direction in the Territory is northeasterly from November to May, southwesterly during some periods in June and July, and easterly for the other periods. Representative months for each of these periods are March, July and August respectively.
- 7.3.4.7 Environmental Protection Department should be consulted on the calculation of air pollutants for estimated traffic flow.

7.3.5 Conformance with Standards

- 7.3.5.1 The principal legislation relating to air pollution is the Air Pollution Control Ordinance (APCO) and its subsidiary Regulations. The maximum tolerable concentrations of foreign matter in the ambient air have been set by the government for seven air pollutants. These are called the Air Quality Objectives (AQO) and are shown in Appendix 3.1 of *Hong Kong Planning Standards and Guidelines (HKPSG)* Chapter 9.
- 7.3.5.2 As far as transport planning and design is concerned, there is a need to evaluate the effects of proposals for future transport systems on air pollution and ensure that the AQO could be achieved as far as is practicable.
- 7.3.5.3 The estimates of future air pollution levels emanating from mobile sources derived from the application of a model may not take cognizance of ambient background levels from other sources. As ambient levels in the Territory may be unusually high, an evaluation of the environmental effects of new transport infrastructure should take that into consideration.
- 7.3.5.4 Air quality results for 1997 indicated that the annual average AQO for respirable suspended particulate (RSP) were exceeded in five of the nine air quality monitoring stations.
- 7.3.5.5 The NO₂ level has risen 20% in the 5-year period to 1997 and exceeded the annual average AQO at one air quality monitoring station in that year. The roadside Air Pollution Index reached the “very high” band nine times in February 1999. Such poor air quality was attributed to high levels of NO₂ measured at the air quality monitoring stations surrounded by tall buildings.
- 7.3.5.6 According to the CTS-3, the transport contributed approximately 65% and 75% of the street level emissions of nitrogen oxides and RSP respectively in 1997.

7.3.6 Measures to Improve Air Quality

- 7.3.6.1 In attempting to minimise the effects of transport systems on air pollution and even improve air quality, it is useful to distinguish air pollution at the regional scale from that at the local scale.
- 7.3.6.2 Regional air pollution refers to the average level of air pollution at the territorial or metropolitan scale. Local air pollution refers to air pollution in the areas immediately adjoining the sources of pollution.

7.3.6.3 The regional scale is most significant for the design of an entire transportation system as in strategic transportation studies similar to the Third Comprehensive Transport Study (CTS-3). The local scale is most significant for the design of transportation projects as with roads within a specific building development, alternative transport links through a corridor, or a transport interchange or terminal. The improvement of air quality and a reduction of noise could be achieved by good engineering design such as the avoidance of steep gradients, sharp bends, and the use of suitable paving materials.

Regional Air Pollution

7.3.6.4 At the regional scale air pollution from mobile sources is best controlled through the application of appropriate transport policies and planning measures. In this respect the major policy directions stated in the CTS-3 SEA Technical Report are most appropriate. These measures could improve the environmental performance of the transport sector through impact avoidance. These are :

- (i) Integrated land-use and transport planning to reduce the need for travel;
- (ii) More extensive rail network and promoting trunk and feeder services to maximise rail usage;
- (iii) Better co-ordination of different transport modes;
- (iv) Park and ride facilities;
- (v) Application of new technologies in traffic management to relieve congestion;
- (vi) Pedestrianisation, possibly along with cycling facilities; and if necessary,
- (vii) The more drastic measures such as restraining the growth and usage of vehicles.

7.3.6.5 The need for vehicle ownership and usage restraint, a higher use of public transport, and a more efficient use of road space to reduce congestion are identified. The better use of road space by all vehicles, including goods vehicles, is environmentally advantageous. That would reduce stop-start movements that generate environmentally destructive exhaust pollutants, particularly from the large proportion of diesel fuel vehicles in the Territory.

7.3.6.6 The effective implementation of the transport policy directives by concerned Departments would undoubtedly assist in improving air quality.

7.3.6.7 Regulations 32 and 33 of the *Road Traffic (Construction and Maintenance of Vehicles) Regulations* impose requirements on the construction of positive-ignition (petrol) and compression-ignition (diesel) engines relating to the emission of gaseous pollutants. Regulation 31 imposes requirements on the construction and maintenance of all motor vehicles regarding the emission of excessive smoke and visible vapours.

7.3.6.8 To control air pollution due to road transport, the Government has been progressively implementing a series of control measures as shown in Table 7.3.6.1.

Local Air Pollution

- 7.3.6.9 Considering the topographical constraints and the concentration of high density development experienced in the Territory, the practicality of controlling air pollution at the local scale is extremely difficult. However, the following measures should be introduced whenever an opportunity exists.
- 7.3.6.10 Given the prevailing winds in Hong Kong are north-easterly for about 70% of a year, major roads should preferably be located west of large residential developments.
- 7.3.6.11 The provision of open space along major roads helps increase the distance between sources and receptors of contaminants, thus permitting greater dilution and dispersion of concentrations of air pollutants before potential receptors are exposed to them. The natural ground cover may exert a cleansing effect on the air passing over it by causing deposition of particulate matter. Systems are available to remove vehicle emissions by forced ventilation and discharge clean air through soil in landscaped areas.
- 7.3.6.12 However, since land is a source commodity particularly in the metropolitan area, open space is usually allocated for various recreational activities. In those circumstances a minimum buffer distance is required between the road and the open space as indicated in Table 7.3.6.2. The provision of a buffer zone is also advantageous for noise abatement.
- 7.3.6.13 Roadside Planting will help trap air borne particles with its branches and leaves. Planting can also improve air quality by carrying out photosynthesis during the day and serve as filter for traffic fumes. Roadside planting should therefore be recommended as one of the mitigation measures for air pollution.
- 7.3.6.14 Public transport interchange (PTI) and petrol filling stations should preferably be located in open areas as their incorporation in building developments could give rise to environmental problems. However, in the metropolitan area where suitable open sites may be in short supply, PTIs may be located in large residential and commercial developments, preferably on the ground floor.

Table 7.3.6.1
Measures Implemented for Air Pollution Control

<u>Objectives</u>	<u>Measures Taken</u>	<u>Effects</u>
Reduce emissions from petrol vehicles	<ul style="list-style-type: none"> • Unleaded petrol phased in since 1991. Complete ban on leaded petrol since 1 April 1999 	<ul style="list-style-type: none"> • No leaded petrol. Virtually eliminates lead emissions from vehicles
	<ul style="list-style-type: none"> • 3-way catalytic converters and trade in incentives for old private cars 	<ul style="list-style-type: none"> • More than 75% of petrol vehicles now have catalytic converters
		<ul style="list-style-type: none"> • For vehicles complying with new standards : <ul style="list-style-type: none"> ◦ NO_x and Hydrocarbons reduced by 90% ◦ Carbon monoxide reduced by 90%
	New vehicles to install controls on evaporative emissions which is planned to take effect in July 1999	<ul style="list-style-type: none"> • Reduce 90% of Volatile Organic Compounds emissions from individual vehicles
Reduce emissions from diesel fleet	<ul style="list-style-type: none"> • Fuel sulphur standards : <ul style="list-style-type: none"> ◦ pre-1995: 0.5% ◦ 1995: 0.2% ◦ 1997: 0.05% ◦ 2001: 0.005% 	<ul style="list-style-type: none"> • SO₂ from individual vehicles reduced by 90%
	<ul style="list-style-type: none"> • Engine standards : <ul style="list-style-type: none"> ◦ Euro I standards adopted in 1995 ◦ Euro II standards adopted by stages since 1997 	<ul style="list-style-type: none"> • For vehicles complying with latest standards : <ul style="list-style-type: none"> ◦ RSP reduced by 80% ◦ NO_x reduced by 20%
	<ul style="list-style-type: none"> • Inspection & enforcement programme <ul style="list-style-type: none"> ◦ smoky vehicle control programme in place since 1988 ◦ step up smoke testing procedures for annual roadworthiness inspection since late 1997 ◦ Police using portable smoke meters for enforcement against smoky vehicle from early 1999 	<ul style="list-style-type: none"> • Smoky vehicle reports reduced by 30% from 1993 to 1998
	<ul style="list-style-type: none"> • Stringent standards for diesel private cars introduced in 1998 	<ul style="list-style-type: none"> • No new diesel private cars have been registered
	<ul style="list-style-type: none"> • All new taxis to use LPG starting end 2000 	<ul style="list-style-type: none"> • Will eliminate RSP emission from individual diesel taxis and reduce overall RSP emission from vehicle fleet by up to 30%
Reduce Volatile Organic Compounds (VOC) emissions	<ul style="list-style-type: none"> • Oil depots installed floating roof oil tanks since 1993 	<ul style="list-style-type: none"> • VOC emissions from oil depots reduced by over 90%
	<ul style="list-style-type: none"> • Vapour recovery system at petrol filling stations since April 1999 	<ul style="list-style-type: none"> • VOC emissions from petrol filling stations reduced by over 30%
Reduce emissions from motorcycles	<ul style="list-style-type: none"> • All new motorcycles to meet stringent emission standards planned for October 1999 	<ul style="list-style-type: none"> • Reduce 50% of VOC emissions from individual motorcycles
Reduce prd emissions	<ul style="list-style-type: none"> • More frequent street cleaning 	<ul style="list-style-type: none"> • Reduce prd emissions
Separate sensitive receivers from vehicle emissions	<ul style="list-style-type: none"> • Introduction of pedestrianisation zones 	<ul style="list-style-type: none"> • Reduce vehicle emissions in pedestrianisation zones

Sources :

(i) *Clean Air for Hong Kong*

(ii) *CTS-3 SEA Technical Report*

Table 7.3.6.2
Guidelines on Usage of Open Space Site with Pollution Source from Road and Highway

Class of road	Buffer distance	Permitted uses
Trunk Road and Primary Distributors	> 20m	Active and passive recreational uses
	3 - 20m	Passive recreational uses
	< 3m	Amenity areas
District Distributors	> 10m	Active and passive recreation uses
	< 10m	Passive recreational uses
Local distributors	> 5m	Active and passive recreation uses
	< 5m	Passive recreational uses

Notes :

- (i) All open spaces under flyovers should be permitted for passive recreational use.
- (ii) Buffer distance is the horizontal shortest distance from edge of road kerb to boundary of open space site.
- (iii) Amenity areas are permitted in any situation.

7.3.6.15

When the PTI is provided in residential and commercial development, the building should be designed with due consideration of the following factors derived from the Practice Note for Professional Persons on Control Air Pollution in Semi-Confined Public Transport Interchange (PN) 1/98 :

- (i) A PTI should be located in an area with access to good background air which can be estimated by taking the 95-percentile of the pollutant concentration data obtained from EPD.
- (ii) To help minimise accumulation of air pollutants, the layout of a PTI should avoid as far as possible solid walls or other barriers that inhibit natural air flow, and should have the vehicle entrances and exits strategically located so as to enhance air movements across the PTI.
- (iii) Ventilation System
 - (a) A PTI ventilation system should consist of fresh air supply units and exhaust air units, with the amount of fresh air supply greater than that of the exhaust air.
 - (b) The fresh air inlets should be away from any major air pollution sources such as busy roads or polluted air outlets so that they can capture fresh air.
 - (c) The exhaust air outlets should be located away from nearby residents or other receptors to avoid causing an air pollutant nuisance.
 - (d) Inside the PTI, the fresh air delivery outlets should be positioned at a low level to discharge fresh air towards the passengers, whereas the extraction openings should be located at a high level.
- (iv) The quantities of carbon monoxide, sulphur dioxide or nitrogen dioxide emissions from the vehicles should be estimated from considering :
 - (a) the types and models of the vehicles using the PTI; and
 - (b) the usage pattern of the vehicles, including speed, frequency, idling time and routing.

- 7.3.6.16 The air quality at passenger waiting areas inside a semi-confined PTI should meet both the 1-hour and 5-minute average air quality guidelines as given in Table 7.3.6.3 extracted from PN 1/98. At other places where passengers stay for not more than 5-minutes, the air quality should at least meet the 5-minute average air quality guidelines.

Table 7.3.6.3
Air Quality guidelines

	<u>Maximum Concentration Not to be Exceeded*</u>	
	1-Hour Average ($\mu\text{g}/\text{m}^3$)	5-Minute Average ($\mu\text{g}/\text{m}^3$)
Carbon Monoxide	30,000	115,000
Sulphur dioxide	800	1,000
Nitrogen dioxide	300	1,800

* expressed at the reference condition of 25°C and 101.325 kPa (one atmosphere)

- 7.3.6.17 The provision of high capacity roads through high density areas raises concerns of air and noise pollution exceeding acceptable levels. Air and noise pollution could be minimised by aligning the road below the ground. However, that would considerably increase capital and operational costs, and could also introduce considerable constructional and operational problems.
- 7.3.6.18 A detailed evaluation, including environmental aspects, of all practical alternative proposals should therefore be performed to select the best proposal. Under the requirement of the EIAO, EIA report should be prepared for designated projects to cover considerations given to different options, and the project's different siting or alignments, including comparison of the main environmental impacts of options.
- 7.3.6.19 In urban road systems, traffic management measures could prove useful in reducing the number of stopping incidents, and eliminating the need for acceleration or deceleration, thus reducing air and noise pollution in adjoining areas. Urban or area traffic control systems have been proven most effective in this respect. Details on the design and operation of such systems are provided in Volume 4.
- 7.3.6.20 The pollution mitigation measures suggested in paragraph 7.3.6.15 can be adopted as appropriate to improve the air quality within noise enclosures, tunnels and ventilation exhausts.
- 7.3.6.21 Programmes for reduction of the number of bus stops in busy areas such as Central, Wan Chai, Causeway Bay and Nathan Road have been implemented. This measure will improve the traffic flow and thereby emissions.

7.4 Noise

7.4.1 General

- 7.4.1.1 Noise reduction measures require a simultaneous consideration of the nature of the sound, the nature of the receiver, and the environment of the receiver.
- 7.4.1.2 It is standard practice in acoustical engineering to measure sound intensity in decibels. The decibel scale is a logarithmic scale which indicates ratios of sound intensities.
- 7.4.1.3 The intensity of a noise is not the only characteristic which causes annoyance. The frequency of the noise is also significant. The human ear is not equally sensitive to all frequencies in the audible range.
- 7.4.1.4 When measurements are made using a sound level meter, this property of the ear is imitated by introducing weighting networks into the equipment. The most frequently used is the "A" weighting, which gives the least sensitivity at low frequencies.
- 7.4.1.5 Procedures given in the U.K. Department of Transport publication, *"Calculation of Road Traffic Noise"*, 1988 edition as adopted by the Environmental Protection Department and reflected in the *Hong Kong Planning Standards and Guidelines*, Chapter 9 are used in this Chapter in addition to information from other sources. For details, refer to both references.

7.4.2 Traffic Noise

- 7.4.2.1 The noise level of individual vehicles is measured in A-weighted decibels, dB(A). Typical levels for cars and lorries are shown in Diagram 7.4.2.1 with comparable levels in other common situations.
- 7.4.2.2 The noise level from a stream of traffic at one instant is the sum of the levels at a particular reception point from many individual vehicles at various distances, and emitting at various intensities. The sum varies from one instant to another.
- 7.4.2.3 The parameter most commonly used to characterise the noise distribution is the sound level exceeded for 10 percent of a defined time interval. Both 1 hour and 18 hour time intervals are used. In Hong Kong 1 hour at time of peak traffic of the day is used for traffic noise prediction and is expressed as L_{10} (1 hour) dB(A).

Source

- 7.4.2.4 Traffic noise emanates from the interaction of tyres and the road surface, from engines, exhausts and brakes. In the case of many heavy goods vehicles, the body of the vehicle itself and supplementary machinery such as refrigeration units produces noise.
- 7.4.2.5 Noise is accentuated by braking and acceleration at junctions and by high speeds. It can also be increased by poor maintenance of vehicles and road surfaces and by poor driving.
- 7.4.2.6 For the purpose of noise prediction, refer to Hong Kong Planning Standards and Guidelines Chapter 9 section 4.
- 7.4.2.7 The variation in the basic noise level hourly L_{10} in dB(A) with a change in the hourly traffic flow at a mean speed of 75 km/h, a traffic composition with no heavy vehicles of unladen weight exceeding 1525kg, and zero gradient is shown in Diagram 7.4.2.2.
- 7.4.2.8 For low traffic flow, the noise level changes more rapidly within the range of 50 to 200 veh/hr than in the range beyond 200 veh/hr. The rate at which the change occurs is also affected by the slant distance (d') between the reception point and the effective source position.

- 7.4.2.9 As heavy commercial vehicles are generally noisier than light ones and private cars, the proportion of the former in a traffic stream has a significant effect on noise levels. The effect is more pronounced at low speeds, reflecting the increased influence of heavy vehicles on the noise level in congested conditions.
- 7.4.2.10 The effect of gradient on traffic noise is complex. The noise level increases due to traffic on an ascending gradient, but there may be some reduction from descending traffic. Heavy vehicles, in particular, lose speed when climbing gradients, and thus the increase in noise level due to the gradient tends to be lessened by the reduction in speed.
- 7.4.2.11 The texture of the road surface could affect the noise level. For impervious bituminous and concrete road surfaces, 1 dB(A) should be subtracted from the basic noise level for speeds less than 75 km/h. Where a bituminous friction course material is used at the surface, a 3.5 dB(A) noise reduction may be assumed.

DIAGRAM 7.4.2.1 : THE LEVEL OF COMMON SOUND ON THE dB(A) SCALE

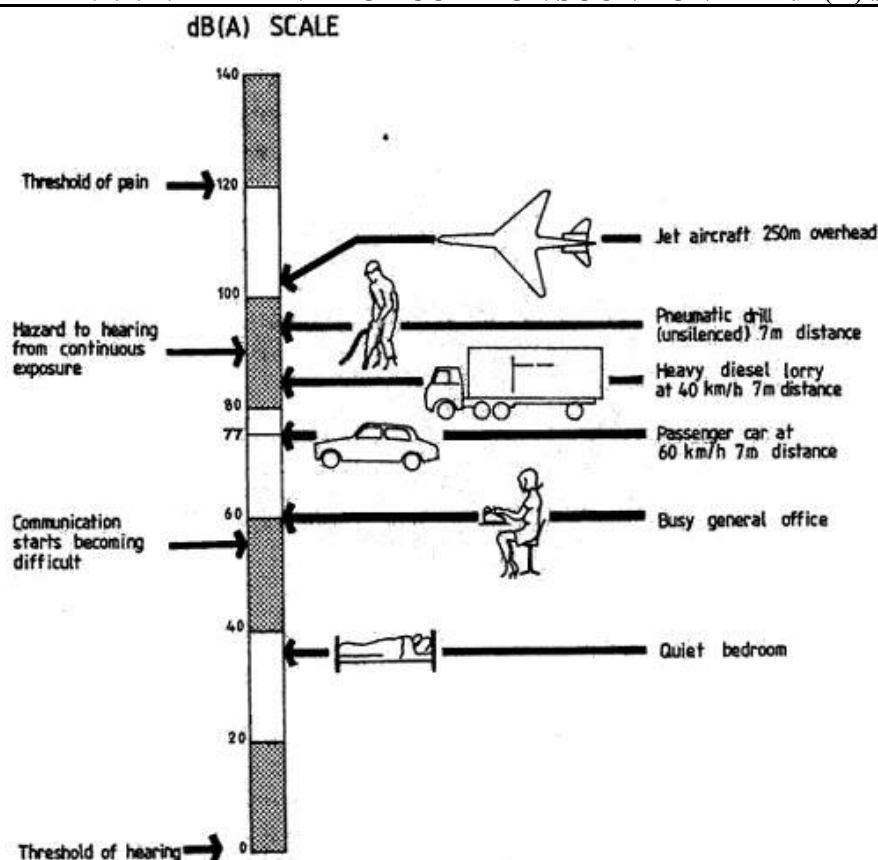

SOURCE : The Environmental Evaluation of Transport Plans

**DIAGRAM 7.4.2.2 : PREDICTION OF BASIC NOISE LEVEL HOURLY L₁₀
IN TERMS OF TOTAL HOURLY FLOW q (V=75 km/h, p=0, G=0)**

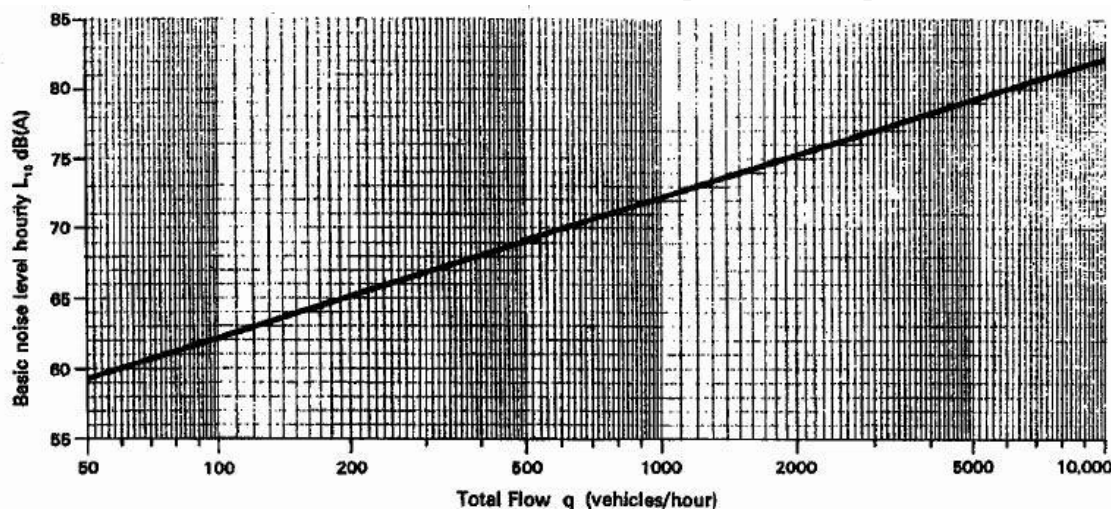

SOURCE : Calculation of Road Traffic Noise

Noise Propagation

7.4.2.12 The noise concerns should be taken into account in both planning and design stages of a road network. In the planning stage, the following should be carefully considered and assessed to minimise the traffic noise impacts :

- (i) alternative transportation mode;
- (ii) vertical and horizontal alignment of the road; and
- (iii) feasibility of incorporating noise mitigation measures including barriers or enclosures.

7.4.2.13 In the design stage, the designer should have the idea of how land should be allotted to build barriers or enclosures. The forms of measures include :

- (i) Underpasses/decking over;
- (ii) Noise barriers (earth berms; vertical, curve or top bent solid wall structures);
- (iii) Noise enclosures (full or semi-enclosures); and
- (iv) Noise reducing highway surfacing.

For details, refer to Paper on 'Noise Mitigation Works for Public Roads' prepared by Highways Department and Environmental Protection Department.

7.4.2.14 The attenuation of noise between source and receiver is largely independent of the noise level at source. Some major influences on traffic noise propagation are :

- (i) road profile;
- (ii) distance;
- (iii) nature of ground;
- (iv) screening - total or partial;
- (v) weather.

- 7.4.2.15 An effective method of reducing traffic noise from adjacent areas is to design the highway so that some form of solid material blocks the sight line between the noise source and the receptors. Diagram 7.4.2.3 provides a schematic illustration of the effect of buildings fronting an at-grade road in shielding other buildings and noise receptors located further away from the road.
- 7.4.2.16 Noise from elevated roads extends over a considerably greater area than would be affected by a similar ground level road, unless high rise buildings are located close to the road. Low rise buildings that fall in the noise shadow created by the road deck are relatively protected, but are ineffective as a screening mechanism.

DIAGRAM 7.4.2.3 : NOISE SHIELDED SHADOW ZONE FOR DIFFERENT BUILDING LAYOUTS

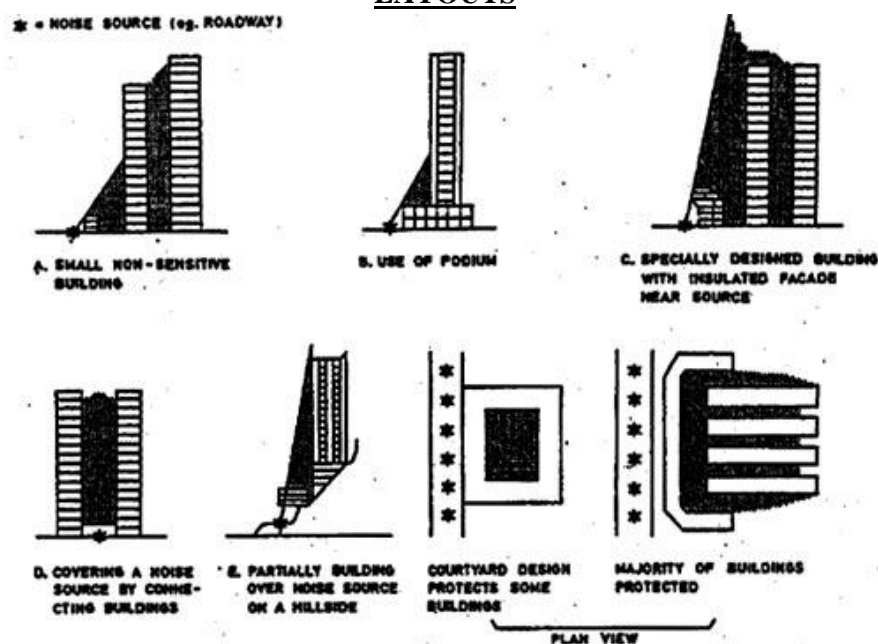

SOURCE : Hong Kong Planning Standards and Guidellne

- 7.4.2.17 The retaining walls of a road in retained cut reduces noise levels adjacent to it. The ground floor of adjacent building is well screened; upper floors are more exposed. Roads in natural cut or vertical retaining walls lined with a sound-absorbent surface considerably reduce the reflection effect.
- 7.4.2.18 Traffic noise generated from a road in tunnel is completely insulated from the external environment except at the points of entry.
- 7.4.2.19 Distance affects both the character and level of traffic noise. Near the road, individual vehicle noise is clearly discernible but at greater distances the variability is reduced. Vehicle noise peaks attenuate at a rate of approximately 6 dB(A) per doubling of distance. For a traffic stream, noise attenuates at about 3 dB(A) for each doubling of distance.
- 7.4.2.20 Diagram 7.4.2.4 indicates the noise attenuation contours in terms of the shortest horizontal distance from the edge of carriageway to the reception point and the vertical distance between the noise emitter and the reception point. For distances less than 4 metres from the edge of carriageway it may be assumed that the reception point is located at the 4-metre distance.
- 7.4.2.21 The nature of the ground surface over which propagation occurs may influence the rate of attenuation in relation to distance. Absorbent surfaces such as grass land or plantations affect the rate of attenuation due to ground absorption, and is dependent on the mean height of propagation (H), the distance between the nearside carriageway and receptor (d), and the proportion of the absorbing ground (I) within that distance. However, the intervening ground cover is largely non-absorbent as in paved areas or over water.

- 7.4.2.22 Where the intervening ground cover is largely absorbent it is usual to assume unit value of 'I'. The value of 'H' is taken to be the average height above the intervening ground along the bisector of the angle subtended by the source line at the reception point. Where the intervening ground is mainly flat, the value of 'H' can be approximated by 0.5 (h + 1) metres. Diagram 7.4.2.5 illustrates the ground absorption correction that should be applied when the ground between the nearside carriageway and the reception point is largely absorbent i.e. I = 1.
- 7.4.2.23 Where the intervening ground cover is largely non-absorbent as in paved areas or over water, no correction is required.
- 7.4.2.24 Where the intervening ground is neither predominantly absorbent nor non-absorbent and the resultant variation in the noise level within the area under consideration is greater than 2 dB(A), the area should be segmented so that each segment would be predominantly absorbent or non-absorbent.
- 7.4.2.25 Roadside barriers consisting of purpose built fences, earth mounds or buildings can reduce levels of noise behind them by up to 20 dB(A). The requirements for the maximum acoustic effectiveness of such a screening device are that it should be substantially free of holes and gaps and have a weight of at least 10 kg/m². Trees and shrubs are useful for the visual masking of traffic but are relatively ineffective for acoustic screening purposes.

DIAGRAM 7.4.2.4 : CORRECTION FOR HORIZONTAL AND VERTICAL DISTANCE

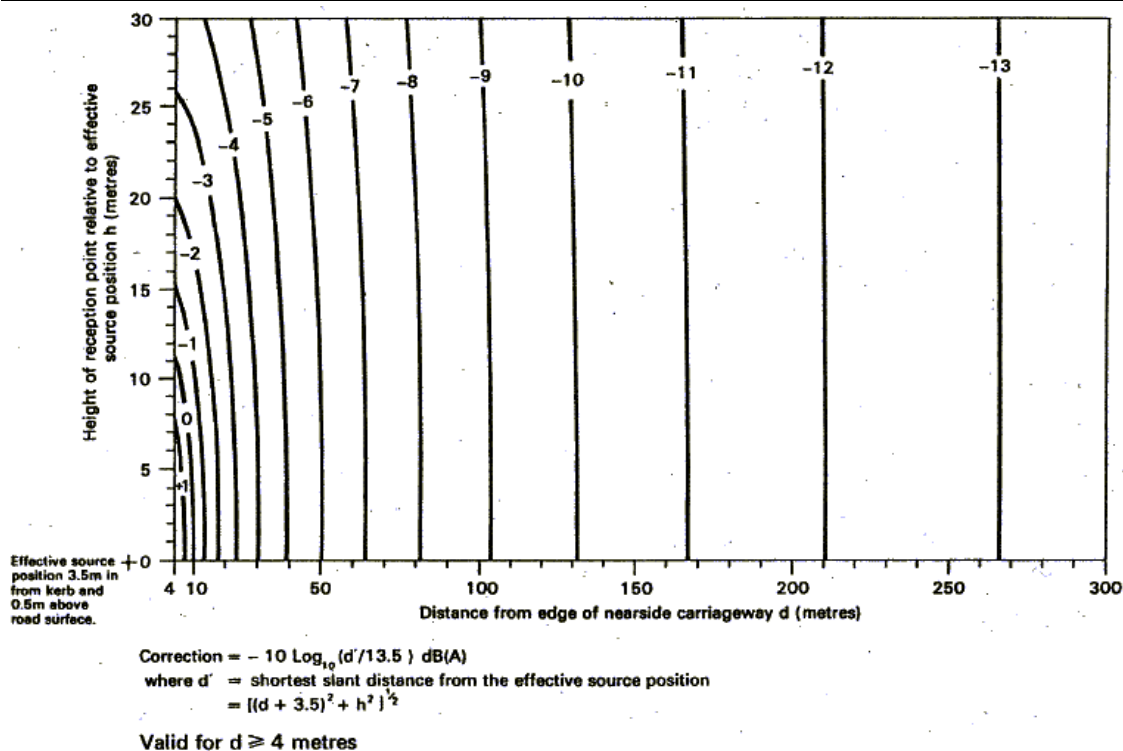

SOURCE : Calculation of Road Traffic Noise

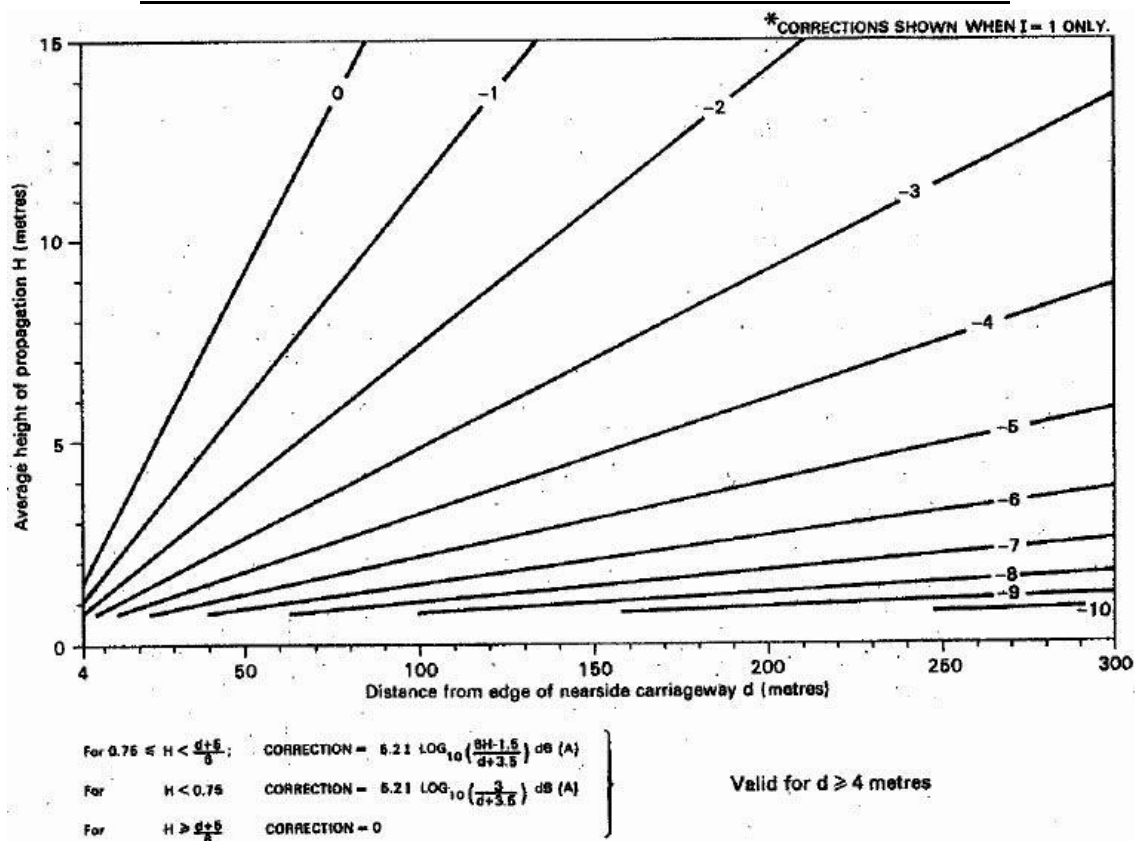
DIAGRAM 7.4.2.5 : CORRECTION FOR GROUND ABSORPTION

SOURCE : Calculation of Road Traffic Noise

- 7.4.2.26 The amount of screening provided by a barrier depends on its height and width in relation to the location of the noise source and the receiver. The shielding effect of a barrier increases with an increase in the difference between the direct path from source to receiver and a path from one to the other, via the top edge of the screen. This effect is illustrated in Diagrams 7.4.2.6 (a) and 7.4.2.7. The potential barrier correction is calculated in the same plane as the distance correction, i.e. normal to the road alignment.
- 7.4.2.27 Where a barrier is provided to reduce noise propagation, the near ground rays are obstructed. Hence, the correction for ground absorption may be ignored.
- 7.4.2.28 Where a barrier is not very long it provides only a partial shielding of the receiver. Consequently, the receiver is exposed to noise coming from both ends of the barrier wall, the lengths subtended by angles θ_2 and θ_3 in Diagram 7.4.2.6(b).
- 7.4.2.29 Reflection of noise from hard rigid surfaces adjacent to the source or in the neighbourhood of the reception point would increase the noise level. To calculate the effect at a reception point 1 metre in front of a facade, a correction of +2.5 dB(A) should be made.
- 7.4.2.30 In noise level calculations, the visible and the obscured sections of the traffic stream are treated as separate source segments. The noise level at the reception point for each segment depends on the angle subtended by the segment boundaries at the reception point. It is often referred to as the "angle of view". The correction for the angle of view is illustrated in Diagram 7.4.2.8.
- 7.4.2.31 The residual noise level at the reception point is determined by combining the corrected noise levels for all segments using Diagram 7.4.2.9.
- 7.4.2.32 The attenuation mechanisms described above affect outdoor noise propagation. In addition, the indoor level is influenced by the layout and construction of a building. For the majority of buildings it is the sound insulation afforded by the windows which determines the internal noise level.

7.4.2.33

The suitable window types in Hong Kong at locations with noise levels in excess of standard are shown in Annex 5 and Annex 13 of *Technical Memorandum on Environmental Impact Assessment Process* under EIAO.

DIAGRAM 7.4.2.6 : SCREENING EFFECT OF A BARRIER

(A) Path difference

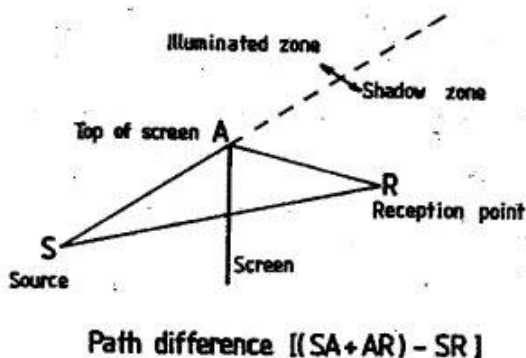

(B) Partial barrier

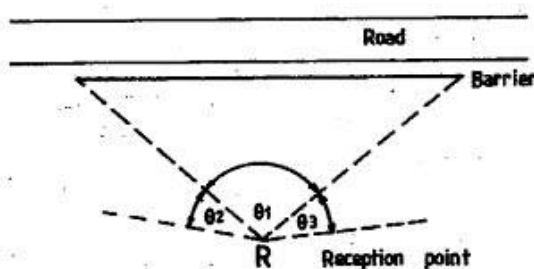

SOURCE : The Environmental Evaluation of Transport Plans and Calculation of Road Traffic Noise

DIAGRAM 7.4.2.7 : POTENTIAL BARRIER CORRECTION AS A FUNCTION OF PATH DIFFERENCE

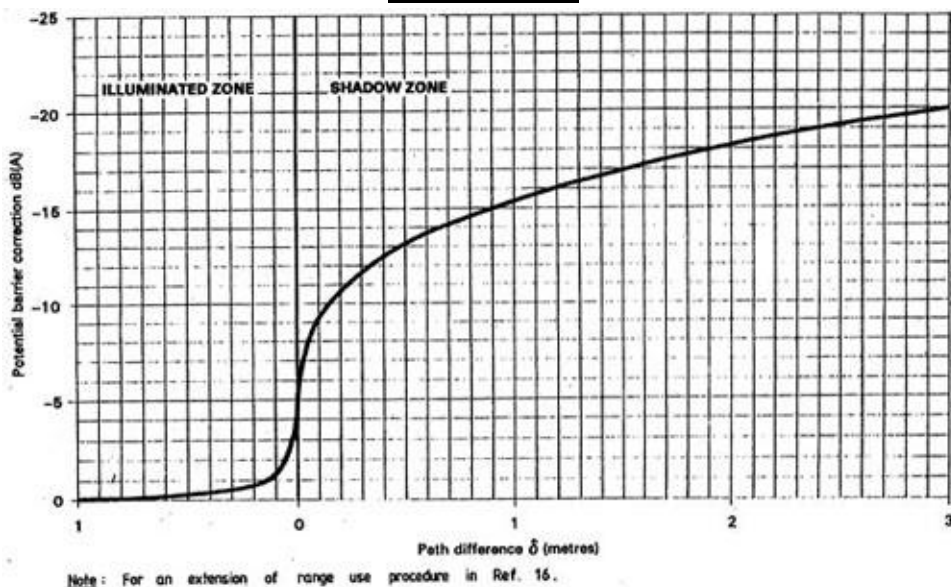

SOURCE : Calculation of Road Traffic Noise

DIAGRAM 7.4.2.8 : CORRECTION FOR ANGLE OF VIEW OF ROAD,θ

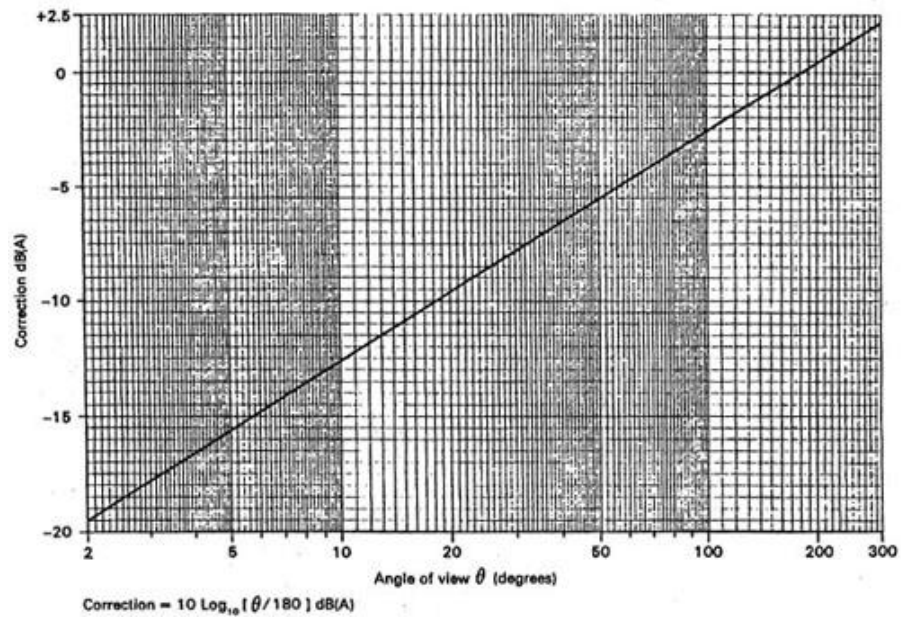

SOURCE : Calculation of Road Traffic Noise

DIAGRAM 7.4.2.9 : PROCEDURE FOR COMBINING NOISE LEVELS

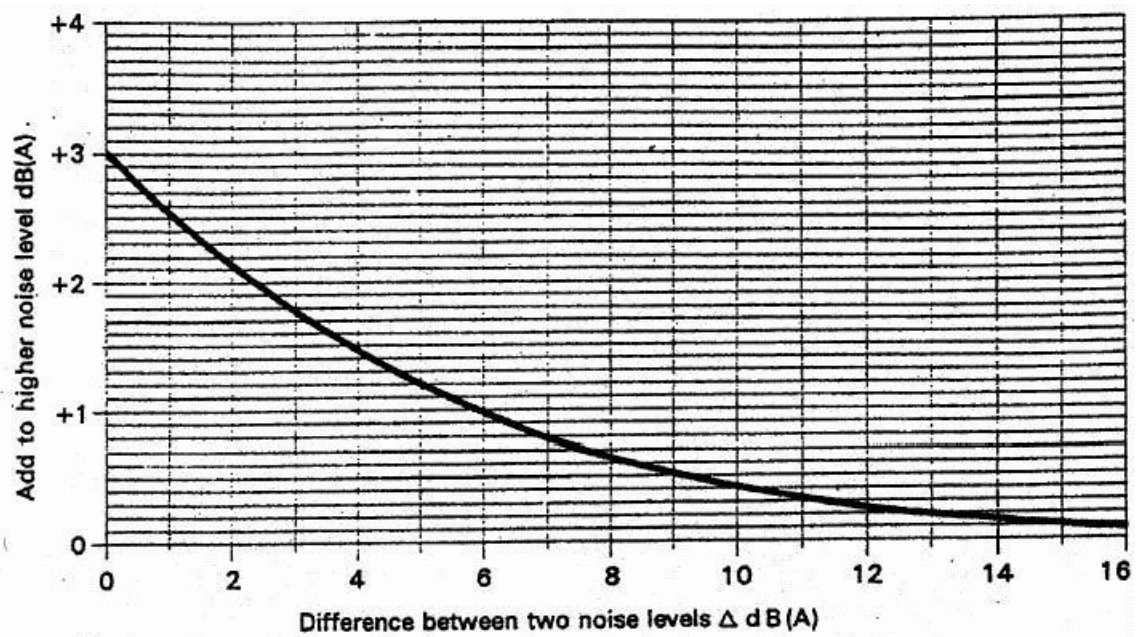

(i) Given two noise levels L and $L - \Delta$ then the combined level is $L + 10 \text{ Log}_{10} [1 + \text{Antilog}_{10} (-\Delta/10)] \text{ dB(A)}$ which can be evaluated using the above chart.

(ii) With n component noise levels L_1, L_2, \dots, L_n the combined noise level due to all n components is given by $L = 10 \text{ Log}_{10} [\sum_{i=1}^n \text{Antilog}_{10} (L_i/10)] \text{ dB(A)}$

SOURCE : Calculation of Road Traffic Noise

7.4.3 Noise Prediction

- 7.4.3.1 The purpose of noise prediction is to quantify the noise level that is likely to be experienced by sensitive receivers as a result of proposed changes in transport facilities and/or traffic conditions. The traffic noise level at the external facades of buildings up to a maximum of 200m from a road is usually computed as a function of traffic parameters, road profile, local topography and the surrounding built form layout.
- 7.4.3.2 Chapter 9 Section 4 of the HKPSG may be referred for an approximate figure of predicted noise at nearby land uses for different traffic conditions.
- 7.4.3.3 The noise level experienced by a receiver at a specified location is derived by first establishing the basic noise level (BNL) due to the traffic characteristics i.e. flow, speed, composition, gradient and road surface. Thereafter, corrections are made for noise attenuation due to spatial separation, barriers and site conditions.
- 7.4.3.4 If the central reserve of a dual carriageway road is wider than 5m or where heights of the outer edges of the two carriageways differ by more than 1 metre, the two carriageways should be treated as separate noise sources. Facade noise levels should be predicted for each and summed thereafter.
- 7.4.3.5 If the ground cover between the road and the receiver is not uniform, or a noise barrier screens only part of the noise source, the corrections mentioned in Section 7.4.2 should be made. The same would apply to a road retained over a short distance in a vertical cut. In this respect, more space provision should be considered to allow greater flexibility in the barrier design, in particular where screen planting is provided to soften the structure.
- 7.4.3.6 In narrow streets the noise levels at the facade of buildings will be increased by reflection from opposite facades. To allow for this effect, the facade noise level should be increased by the reflection correction shown in Diagram 7.4.3.1.
- 7.4.3.7 Where a road is provided in a natural cut, the embankment is unlikely to be sound reflecting. However, in a retained cut noise will be reflected from the farside retaining wall thus increasing facade noise levels. For details refer Calculation of Road traffic Noise.
- 7.4.3.8 Buildings parallel to and fronting a road form a noise barrier that shields buildings set further back from the road. Where the road is at grade the facade noise level reduction with distance attenuation is generally significant and Calculation of Road traffic Noise gives a method of assessment.
- 7.4.3.9 If the road is elevated or depressed, the path difference method indicated in Section 7.4.2.25 should be used assuming the buildings fronting the road to act as a barrier of equivalent height. A large attenuation figure from the screening effect can normally obtain except when the buildings fronting the road are of particularly short lengths at large distance of separation between them.

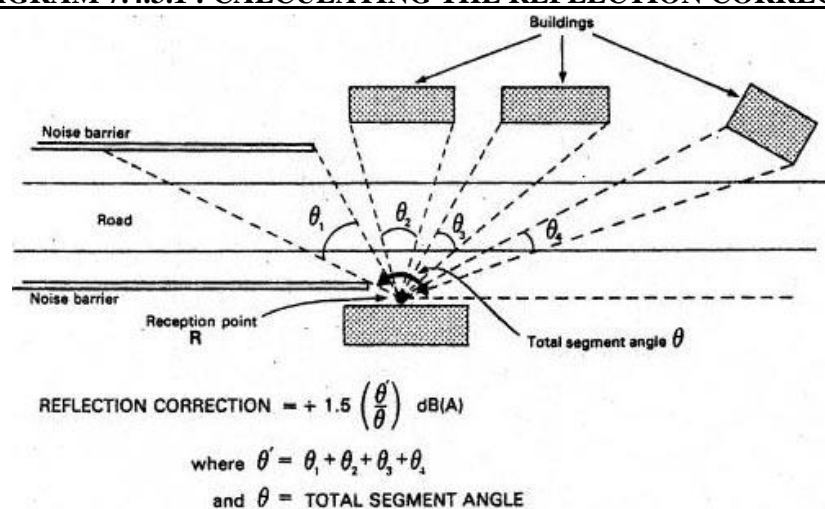
DIAGRAM 7.4.3.1 : CALCULATING THE REFLECTION CORRECTION

SOURCE : Calculation of Road Traffic Noise

7.4.4 Conformance with Standards

7.4.4.1 The principal standard and guidelines relating to road traffic noise pollution are stated in Annex 5 and Annex 13 of *Technical Memorandum on Environmental Impact Assessment Process* under EIAO.

7.4.4.2 When designing roads or other transport infrastructure, noise levels should be considered in relation to anticipated traffic volumes and the location of committed and planned sensitive land uses. When predicted noise levels exceed the standards, noise mitigation measures should be considered from the outset of planning and provisions should be made of their incorporation into the road/transport infrastructure.

7.4.5 Measures to Reduce Noise Effects from Transport Systems

7.4.5.1 As with air quality, the transport policy indicated in Section 7.3.6.4 will help minimise the noise level generated from the internal transport system.

7.4.5.2 However, from the point of view of transport planning the regional noise level concept, defined as the average territorial or metropolitan noise level, is not very useful. Noise created by a transport system is essentially a local phenomenon, that is, its primary effect is on areas immediately adjacent to the transport facility.

7.4.5.3 Noise caused by a transport system may be reduced by the reduction of noise at source or the control of the path of the noise, which includes the location of the source relative to sensitive receptors.

7.4.5.4 The reduction of traffic volumes, diversion of commercial vehicles from noise sensitive areas, the use of underground alignments, the regular maintenance of the road surface in a good state of repair, and the use of traffic control systems that would minimise the frequency of stop-start incidents are some forms of noise reduction at source, similar to those for improving air quality.

7.4.5.5 Bituminous friction course material could produce about 3.5 dB(A) noise reduction against a concrete surface, and should be designed as the uppermost pavement layer at any site if tyre/road surface noise is the main criteria.

- 7.4.5.6 Barriers, either as earth berms or solid fences, can prove effective in reducing noise emanated from transport facilities, by interrupting the direct sound path between the source and receiver. However, they are effective primarily in areas of low-rise buildings, which is unusual particularly in the Metropolitan areas. The EPD should be consulted for the detailed design of such structures.
- 7.4.5.7 The internal arrangement of buildings may be designed to protect sensitive uses from direct exposure to emitters of traffic noise. The suitable integration of a transport facility (public transport terminal etc.) into a building development could enhance transport interchange without introducing noise impediments. Further information on these aspects could be found in the HKPSG.
- 7.4.5.8 Insulation is an effective means of reducing the noise level within a building. However, it deprives the occupants of an "open window" style of living. In the warm, humid climate experienced in the Territory, air-conditioning would be required where buildings are insulated from noise using a "closed-window" environment. That could prove quite expensive as electricity consumption for air-conditioning is relatively high. This form of noise mitigation measure would only be regarded as the "last resort" by EPD after all direct technical measures, such as alternative road alignment, landscaped/purpose built barriers, etc., have been considered. The choice of measure shall take into account of noise reduction effectiveness, cost of installation and the size of protected population.
- 7.4.5.9 A number of road traffic noise mitigation examples have been installed in Hong Kong. Additional information with respect to direct technical measures mentioned in para. 7.4.5.8 could be obtained from EPD.

7.5 Visual Effects

7.5.1 Perception

- 7.5.1.1 Since visual perception varies with the individual, visual effects defy precise definition. However, broad areas of agreement about visual perception of the environment do exist.
- 7.5.1.2 A transport facility can be considered from three aspects namely, structure, function, and form. The structure of a facility refers to the materials and standards of its construction. Its function is reflected in elements such as the characteristics of its traffic stream, the levels of safety, its location etc. The form of a transport facility refers to its visible aspects or external appearance and is derived from the arrangement of its parts.
- 7.5.1.3 The visual aspects refer not only to the facility itself, but also to its relationship to the environment. Since a transport facility can be seen whether or not it is travelled on, its visual effects are two fold i.e. those of the traveller, and those of observers in adjoining communities.
- 7.5.1.4 Since a person in motion sees the environment differently from a person standing still, a strong possibility exists of conflict between the aesthetic point of view of the highway user and that of the non-user. The visual details may diminish with increase in viewing speed and viewing distance.
- 7.5.1.5 An elevated structure is aesthetically more desirable to the highway user because of the view it offers. However to the non-user, an elevated structure, no matter how graceful, may appear to disrupt the continuity of lateral space when viewed against its surroundings.
- 7.5.1.6 In high density urban areas, whether they are commercial, residential or institutional, elevated structures may constitute barriers, reduce the amount of light available below them, interfere with the continuity of pedestrian spaces, and often create undefined and non productive space beneath the structure.

7.5.2 Measurement

- 7.5.2.1 Although precise measurement of visual effects may not be possible, some quantification of visual intrusion can be performed by determining how much of the field of view is taken up by the intruding element. This is best represented by the solid angle subtended by the field of view of the intruding element and expressed in milliradians.
- 7.5.2.2 The solid angle is defined as the angle subtended at the centre of a sphere of unit radius, by a unit area on its surface. The unit is called a steradian.
- 7.5.2.3 The basic formula used in solid angle calculation for roads of all profiles is expressed as :

$$S_{\theta} = \frac{H}{dp} (\cos \theta_1 - \cos \theta_2)$$

Where

H is the height of the intruding structure.

dp is the perpendicular distance between an observer and the structure.

θ_1 & θ_2 are the angles subtended by the visible extremities of the structure at the point of observation with a datum line parallel to the structure.

- 7.5.2.4 The effect of the viewing distance on the solid angle is shown in Diagram 7.5.2.1.
- 7.5.2.5 The intrusiveness of an element in the field of view also depends on the position of that element in relation to the direction of view. An object subtending a given solid angle at the centre of the field of vision is more intrusive than when it is located near the periphery of the visual field.

- 7.5.2.6 The visual field could be divided into zones. The central zone of radius 20° about the direction of view is the zone of maximum significance. Hence, a measure of the solid angle (S_{40}) within the central 40° (20° on each side of the central direction of view) of the field of view represents the extent of intrusion that requires attention.
- 7.5.2.7 The solid angle can easily be calculated using the above formula but it could be time consuming when several repetitive calculations are required. For expeditious application, Appendix I provides values of S_{40} for the likely ranges of perpendicular distance, road height and road orientation relative to the observer's direction of view.
- 7.5.2.8 Solid angle protractors can also be used for the rapid calculation of solid angles. There are two types, the simple protractor and the solid angle protractor.

DIAGRAM 7.5.2.1 : THE EFFECT OF DISTANCE ON SOLID ANGLE

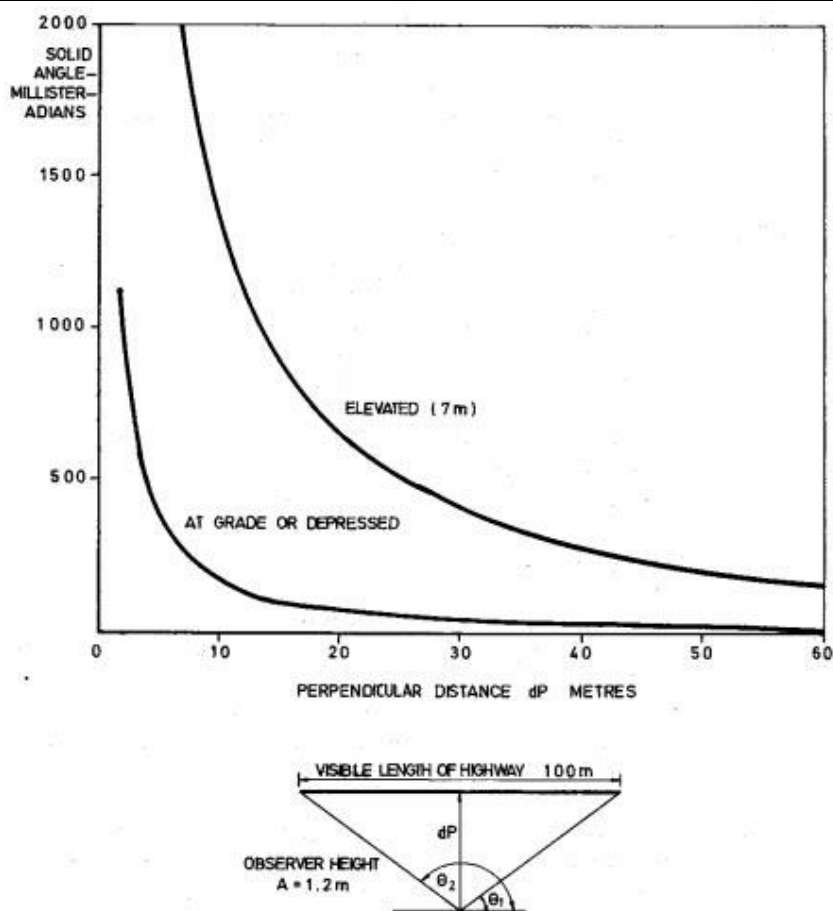

NOTE : ALL DIAGRAMS IN THIS SECTION ARE REPRODUCED FROM REFERENCE 5.

Simple Protractor

- 7.5.2.9 A simple protractor, shown in Diagram 7.5.2.2 is placed on a plan of the road, with point O at the mid-point of the facade of a dwelling from which the visual effect is studied, and datum line ON perpendicular to the road. The "cos θ " values around the periphery of the protractor are recorded for the rays at the limits of the visible length of the structure.
- 7.5.2.10 If both limits fall within the same quadrant the "cos" values are subtracted, if in different quadrants the values are added. The value derived corresponds to $(\cos \theta_1 - \cos \theta_2)$ in the formula.
- 7.5.2.11 The smaller disc is used to obtain the solid angle S in the central zone of vision. The smaller disc is placed on the larger protractor and is rotated so that the base line AA is set along the facade of the dwelling. The "cos θ " values are adjusted so as to exclude any section of the structure where the rays fall within the shaded area.

- 7.5.2.12 To use the solid angle prediction chart shown in Diagram 7.5.2.3, point A is defined by the height H and perpendicular distance dp. A line from the origin through A is extended to meet the vertical line representing the value $(\cos \theta_1 - \cos \theta_2)$ at B. The horizontal line through B is extended to meet the right hand axis to obtain the solid angle subtense in milliradians.

Solid Angle Protractor

- 7.5.2.13 A solid angle protractor is illustrated in Diagram 7.5.2.4. It is set with the origin 0 over the observer point and with the line ON perpendicular to the proposed highway alignment. The arms OP and OQ are set to the limits of the visible length of highway structure.
- 7.5.2.14 Scale A measures the value $(\cos \theta_1 - \cos \theta_2)$. It is moved so that the zero reading on the scale is below point P1 (opposite end of arm P). The reading on scale A vertically below point Q, records the value $(\cos \theta_1 - \cos \theta_2)$.
- 7.5.2.15 Disc D of the circular calculator is rotated so that the datum line in window C registers the effective height of the highway structure. Disc E is rotated so that the pointer registers on the outer scale B the value of $(\cos \theta_1 - \cos \theta_2)$ which is transferred from scale A. The solid angle subtense is read on scale E corresponding to the perpendicular distance dp shown on scale D.

DIAGRAM 7.5.2.2 : SIMPLIFIED SOLID ANGLE PROTRACTOR

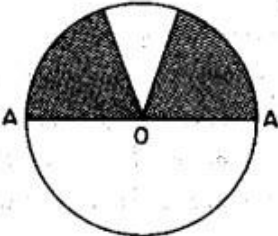
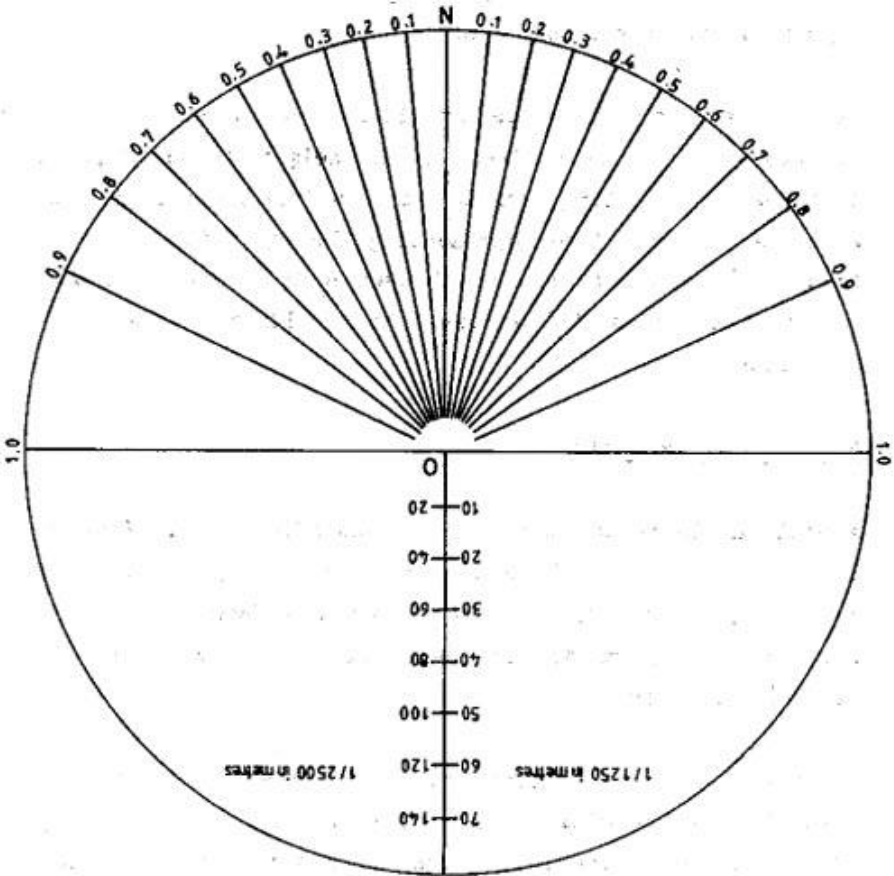
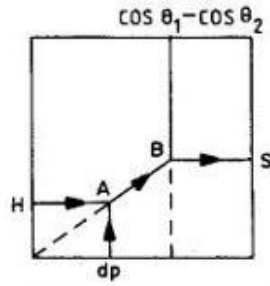

DIAGRAM 7.5.2.3 : CHART FOR PREDICTION OF SOLID ANGLE SUBTENSE



USE OF SOLID ANGLE PREDICTION CHART

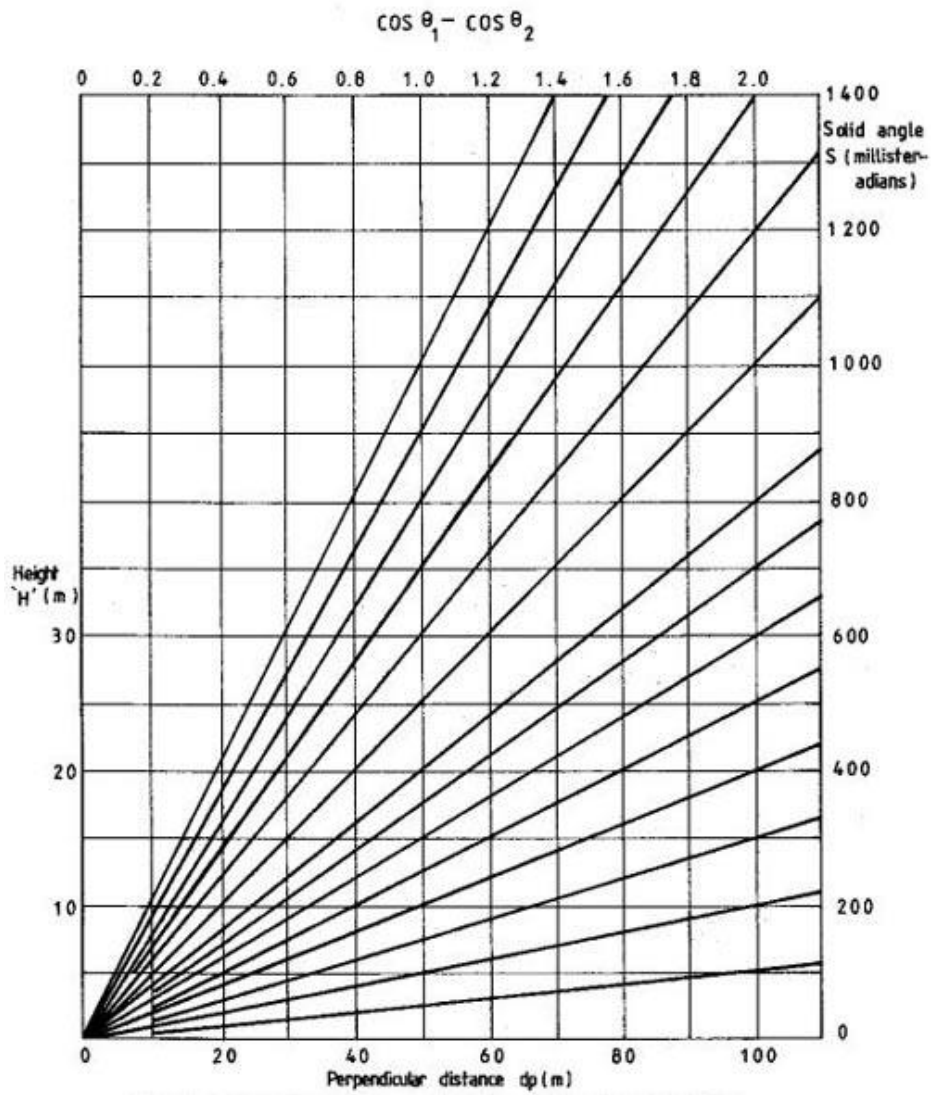
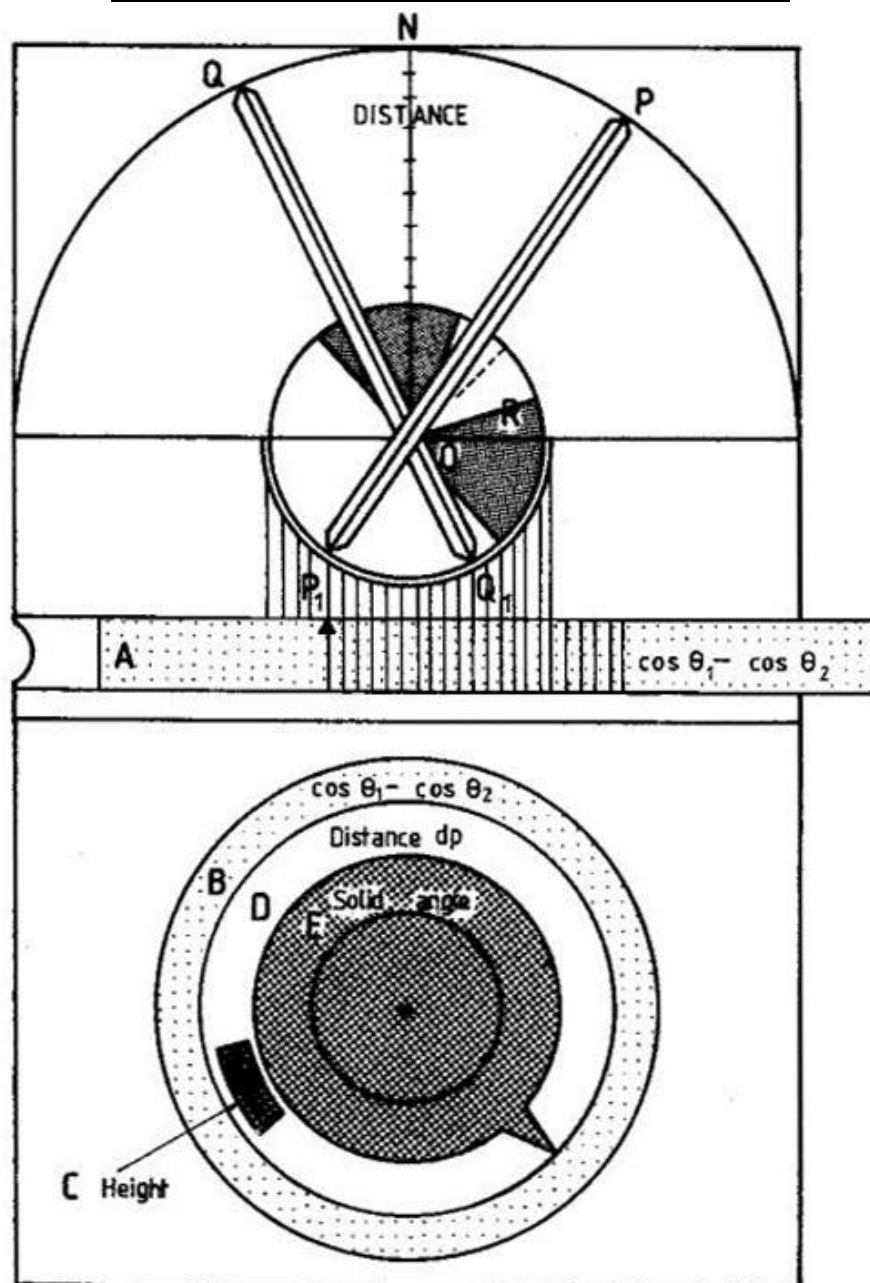

DIAGRAM 7.5.2.4 : SOLID ANGLE PROTRACTOR

7.5.3 Scale of Visual Judgements

- 7.5.3.1 The previous section deals with the solid angle concept used in a quantified description of the content of a view, and the measurement of the solid angle. Its application in the prediction of judgements of visual quality provides an useful measure of acceptability on a suitable scale.
- 7.5.3.2 Surveys of randomly selected respondents in urban and suburban locations in the UK were conducted some years back to provide a basis to translate the solid angle concept into the assessment of judgements of visual quality. The relationship derived is shown in Diagram 7.5.3.1.
- 7.5.3.3 Up to values of about 25 milliradians, judgements are largely unrelated to the solid angle. Above that value visual quality declines as solid angle increases to a value of 379 mS, the maximum possible within the central cone.

- 7.5.3.4 In addition to this quantified aspect of the content of a view, the aesthetic concepts and considerations outlined in the Civil Engineering Manual Volume V Section 4.17, Section 7 of Annex 18 of Technical Memorandum on Environmental Impact Assessment Process and Chapter 17 of Structures Design Manual for Highways and Railways require attention. To ensure that these and other visual effects are given due consideration the designs of all bridges and associated structures over, under, on or adjacent to public roads, including new roads, in the Territory should be approved by "The Advisory Committee on the Appearance of Bridges and Associated Structures (ACABAS)".
- 7.5.3.5 Full details regarding the scope, terms of reference, membership, procedure for submissions etc. relating to ACABAS are given in Works Bureau Technical Circular No. 19/98 and 19/98A. To avoid resource being wasted on the detailed design of an unsatisfactory concept, submissions to obtain the approval of ACABAS should as far as practical be made at the preliminary design stage.
- 7.5.3.6 Consultancy Briefs for engineering feasibility and transport studies that requires the preparation of preliminary designs should include a requirement that the approval of ACABAS be obtained as appropriate.
- 7.5.3.7 As landscape planting will help to soften the engineering structures and improve the environmental quality along public roads, feasibility to plant on, under or alongside the structure should be duly considered.

DIAGRAM 7.5.3.1 : VISUAL JUDGEMENTS VERSUS ROAD SOLID ANGLE

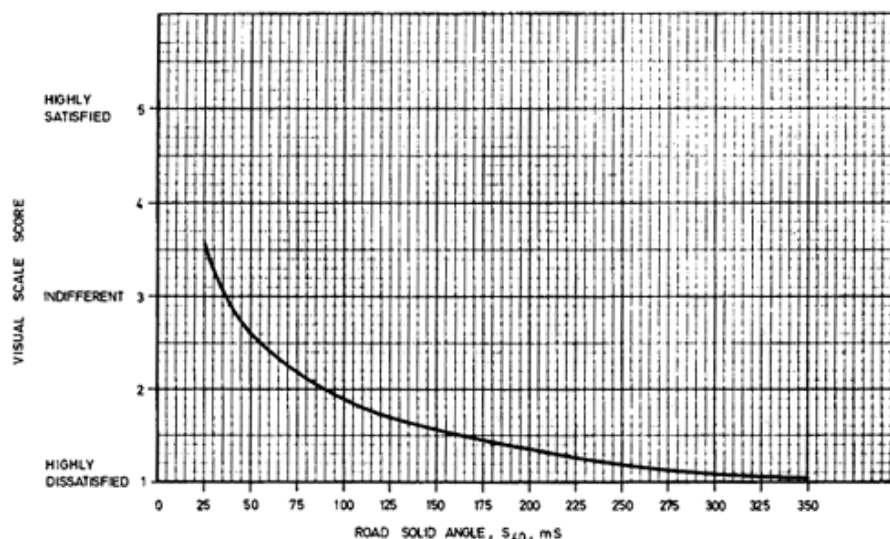

Appendix I

Solid Angles S_{40} Tables

Tables have been prepared recording the solid angle subtense for the view, 20° on either side of the normal to the dwelling facade. The tables record values of S_{40} (milliradians), for a range of distances from the road dp , and for varying angles of orientation of the dwelling facade, α° . The solid angle values assume that there is no obstruction to the view of the road within the 40° field.

Figure A1.1 SOLID ANGLE S_{40} TABLES

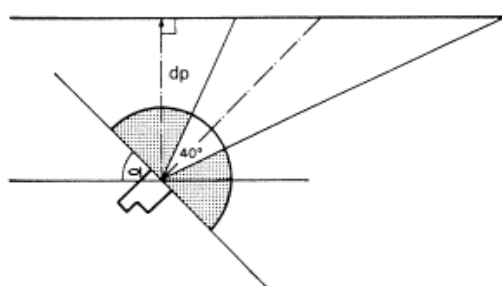

Table heading - H is the effective height of road (metres).

Row reading - dp is the distance of the normal from the observer point P to the highway (metres).

Column heading - α is the angle between the facade of the building and a line through P parallel to the road.

Table contents - $S(40 \text{ degrees})$ is the solid angle (milliradians).

$$\mathbf{H = 1}$$

Perpendicular distance	α°											
	0	10	20	30	40	50	60	70	80	90	100	110
10	68	67	64	59	52	44	34	23	13	6	2	0
20	34	34	32	30	26	22	17	12	7	3	1	0
30	23	22	21	20	17	15	11	8	4	2	1	0
40	17	17	16	15	13	11	9	6	3	2	0	0
50	14	13	13	12	10	9	7	5	3	1	0	0
60	11	11	11	10	9	7	6	4	2	1	0	0
70	10	10	9	8	7	6	5	3	2	1	0	0
80	9	8	8	7	7	5	4	3	2	1	0	0
90	8	7	7	7	6	5	4	3	1	1	0	0
100	7	7	6	6	5	4	3	2	1	1	0	0
110	6	6	6	5	5	4	3	2	1	1	0	0
120	6	6	5	5	4	4	3	2	1	1	0	0

Source : *The Environmental Evaluation of Transport Plan*

H = 2

Perpendicular distance	α°											
	0	10	20	30	40	50	60	70	80	90	100	110
10	137	135	129	118	105	88	68	47	27	12	3	0
20	68	67	64	59	52	44	34	23	13	6	2	0
30	46	45	43	39	35	29	23	16	9	4	1	0
40	34	34	32	30	26	22	17	12	7	3	1	0
50	27	27	26	24	21	18	14	9	5	2	1	0
60	23	22	21	20	17	15	11	8	4	2	1	0
70	20	19	18	17	15	13	10	7	4	2	0	0
80	17	17	16	15	13	11	9	6	3	2	0	0
90	15	15	14	13	12	10	8	5	3	1	0	0
100	14	13	13	12	10	9	7	5	3	1	0	0
110	12	12	12	11	10	8	6	4	2	1	0	0
120	11	11	11	10	9	7	6	4	2	1	0	0

H = 3

Perpendicular distance	α°											
	0	10	20	30	40	50	60	70	80	90	100	110
10	205	202	193	178	157	132	103	70	40	18	5	0
20	103	101	96	89	79	66	51	35	20	9	2	0
30	68	67	64	59	52	44	34	23	13	6	2	0
40	51	51	48	44	39	33	26	18	10	5	1	0
50	41	40	39	36	31	26	21	14	8	4	1	0
60	34	34	32	30	26	22	17	12	7	3	1	0
70	29	29	28	25	22	19	15	10	6	3	1	0
80	26	25	24	22	20	16	13	9	5	2	1	0
90	23	22	21	20	17	15	11	8	4	2	1	0
100	21	20	19	18	16	13	10	7	4	2	0	0
110	19	18	18	16	14	12	9	6	4	2	0	0
120	17	17	16	15	13	11	9	6	3	2	0	0

H = 4

Perpendicular distance	α°											
	0	10	20	30	40	50	60	70	80	90	100	110
10	274	269	257	237	210	176	137	94	54	24	3	0
20	137	135	129	118	105	88	68	47	27	12	2	0
30	91	90	86	79	70	59	46	31	18	8	1	0
40	63	67	64	59	52	44	34	23	13	6	1	0
50	55	54	51	47	42	35	27	19	11	5	1	0
60	46	45	43	39	35	29	23	16	9	4	1	0
70	39	38	37	34	30	25	20	13	8	3	0	0
80	34	34	32	30	26	22	17	12	7	3	0	0
90	30	30	29	26	23	20	15	10	6	3	0	0
100	27	27	26	24	21	18	14	9	5	2	0	0
110	25	24	23	22	19	16	12	9	5	2	0	0
120	23	22	21	20	17	15	11	8	4	2	1	0

H = 5

Perpendicular distance	α°											
	0	10	20	30	40	50	60	70	80	90	100	110
10	342	337	321	296	262	220	171	117	67	30	8	0
20	171	168	161	148	131	110	85	58	33	15	4	0
30	114	112	107	99	87	73	57	39	22	10	3	0
40	85	84	80	74	65	55	43	29	17	8	2	0
50	68	67	64	59	52	44	34	23	13	6	2	0
60	57	56	54	49	44	37	28	19	11	5	1	0
70	49	48	46	42	37	31	24	17	10	4	1	0
80	43	42	40	37	33	27	21	15	8	4	1	0
90	38	37	36	33	29	24	19	13	7	3	1	0
100	34	34	32	30	26	22	17	12	7	3	1	0
110	31	31	29	27	24	20	16	11	6	3	1	0
120	28	28	27	25	22	18	14	10	6	3	1	0

H = 6

Perpendicular distance	α°											
	0	10	20	30	40	50	60	70	80	90	100	110
*10	379	379	379	355	314	264	205	140	80	36	9	0
20	205	202	193	178	157	132	103	70	40	18	5	0
30	137	135	129	118	105	88	68	47	27	12	3	0
40	103	101	96	89	79	66	51	35	20	9	2	0
50	82	81	77	71	63	53	41	28	16	7	2	0
60	68	67	64	59	52	44	34	23	13	6	2	0
70	59	58	55	51	45	38	29	20	11	5	1	0
80	51	51	48	44	39	33	26	18	10	4	1	0
90	46	45	43	39	35	29	23	16	9	4	1	0
100	41	40	39	36	31	26	21	14	8	4	1	0
110	37	37	35	32	29	24	19	13	7	3	1	0
120	34	34	32	30	26	22	17	12	7	3	1	0

* The maximum possible S_{40} value is 379 mS.

H = 7

Perpendicular distance	α°											
	0	10	20	30	40	50	60	70	80	90	100	110
*10	379	379	379	379	367	308	239	164	94	42	11	0
20	239	236	225	207	183	154	120	82	47	21	5	0
30	160	157	150	138	122	103	80	55	31	14	4	0
40	120	118	112	104	92	77	60	41	23	11	3	0
50	96	94	90	83	73	62	48	33	19	8	2	0
60	80	79	75	69	61	51	40	27	16	7	2	0
70	68	67	64	59	52	44	34	23	13	6	2	0
80	60	59	56	52	46	38	30	20	12	5	1	0
90	53	52	50	46	51	34	27	18	10	5	1	0
100	48	47	45	41	37	31	24	16	9	4	1	0
110	44	43	41	38	33	28	22	15	9	4	1	0
120	40	39	37	35	31	26	20	14	8	4	1	0

* The maximum possible S_{40} value is 379 mS.

H = 8

Perpendicular distance	α°											
	0	10	20	30	40	50	60	70	80	90	100	110
*10	379	379	379	379	379	352	274	187	107	48	12	0
20	274	269	257	237	210	176	137	94	54	24	6	0
30	182	180	171	158	140	117	91	62	36	16	4	0
40	137	135	129	118	105	88	68	47	27	12	3	0
50	109	108	103	95	84	70	55	37	21	10	2	0
60	91	90	86	79	70	59	46	31	18	8	2	0
70	78	77	73	68	60	50	39	27	15	7	2	0
80	68	67	64	59	52	44	34	23	13	6	2	0
90	61	60	57	53	47	39	30	21	12	5	1	0
100	55	54	51	47	42	35	27	19	11	5	1	0
110	50	49	47	43	38	32	25	17	10	4	1	0
120	46	45	43	39	35	29	23	16	9	4	1	0

* The maximum possible S_{40} value is 379 mS.

H = 9

Perpendicular distance	α°											
	0	10	20	30	40	50	60	70	80	90	100	110
*10	379	379	379	379	379	379	308	210	121	54	14	0
20	308	303	289	266	236	198	154	105	60	27	7	0
30	205	202	193	178	157	132	103	70	40	18	5	0
40	154	152	145	133	118	99	77	53	30	14	3	0
50	123	121	116	107	94	79	62	42	24	11	3	0
60	103	101	96	89	79	66	51	35	20	8	2	0
70	88	87	83	76	67	57	44	30	17	8	2	0
80	77	76	72	67	59	49	38	26	15	7	2	0
90	68	67	64	59	52	44	34	23	13	6	2	0
100	62	61	58	53	47	40	31	21	12	5	1	0
110	56	55	53	48	43	36	28	19	11	5	1	0
120	51	51	48	44	39	33	26	18	10	5	1	0

* The maximum possible S_{40} value is 379 mS.

H = 10

Perpendicular distance	α°											
	0	10	20	30	40	50	60	70	80	90	100	110
*10	379	379	379	379	379	379	342	234	134	60	15	0
20	342	337	321	296	262	220	171	117	67	30	8	0
30	228	224	214	197	175	147	114	78	45	20	5	0
40	171	168	161	148	131	110	85	58	33	15	4	0
50	137	135	129	118	105	88	68	47	27	12	3	0
60	114	112	107	99	87	73	57	39	22	10	3	0
70	98	96	92	85	75	63	49	33	19	9	2	0
80	85	84	80	74	65	55	43	29	17	8	2	0
90	76	75	71	66	58	49	38	26	15	7	2	0
100	68	67	64	59	52	44	34	23	13	6	2	0
110	62	61	58	54	48	40	31	21	12	5	1	0
120	57	56	54	49	44	37	28	19	11	5	1	0

* The maximum possible S_{40} value is 379 mS.

H = 11

Perpendicular distance	α°											
	0	10	20	30	40	50	60	70	80	90	100	110
*10	379	379	379	379	379	379	379	257	147	66	17	0
*20	379	379	353	326	288	242	188	129	74	33	8	0
30	251	247	236	217	192	161	125	86	49	22	6	0
40	188	185	177	163	144	121	94	64	37	17	4	0
50	150	148	141	130	115	97	75	51	29	13	3	0
60	125	123	118	109	96	81	63	43	25	11	3	0
70	107	106	101	93	82	69	54	37	21	9	2	0
80	94	93	88	81	72	60	47	32	18	8	2	0
90	84	82	79	72	64	54	42	29	16	7	2	0
100	75	74	71	65	58	48	38	26	15	7	2	0
110	68	67	64	59	52	44	34	23	13	6	2	0
120	63	62	59	54	48	40	31	21	1	2	1	0

* The maximum possible S_{40} value is 379 mS.

TPDM Volume 6 Chapter 8 – Facilities for People with Disabilities

8.1 References

1. Design Manual : Barrier Free Access 2008, Buildings Department.
2. Report, "Site Evaluation by Wheelchair Users of Ramped Access to Pedestrian Structures", Working Group on the Construction of Highway Facilities for the Disabled
3. "Providing for People with a Mobility Handicap", The Institution of Highways and Transportation
4. "Guidelines for Making Pedestrian Crossing Structures Accessible", U.S. Department of Transportation, August 1984
5. Report by the American Council of the Blind on Tactile Tiles and Guide Strips, July 1985
6. Report on the Survey of Facilities for the Disabled in the Central Business District, Geelong, Victoria, Australia
7. "Providing for the Disabled Highway User", R.R. Lyon, Municipal Engineer, April 1983
8. "Code of Practice for the Lighting, Signing and Guarding of Road Works", Highways Department
9. "Guidance on the use of Tactile Paving surfaces", the Department of the Environment, Transport and Regions, UK, 1998
10. Recommended specification for low-floor buses, Disabled Persons Transport Advisory Committee (DPTAC), UK
11. Structures Design Manual for Highways and Railways, Highways Department
12. Consultancy Study for Enhancement of the Accessibility of Physical Environment in Hong Kong, Labour and Welfare Bureau

8.2 Introduction

8.2.1 General

8.2.1.1 This Chapter aims to bring to the attention of the Designer :

- (i) the reasons and needs to consider people with disabilities when designing highway or transport systems; and
- (ii) the design of barrier-free highway and transport facilities for people with disabilities.

8.2.1.2 This Chapter is also intended to detail the general guidelines on the design and provision of facilities for people with disabilities and promote awareness of such factors for project implementation. If the recommended provisions cannot be fully incorporated due to various reasons, advice should be sought from the Road Safety and Standards Division of the Transport Department.

8.2.1.3 Detailed design of highway facilities are given in other Chapters and Volumes whilst those particulars aiming to facilitate access by people with disabilities are provided in this Chapter.

8.2.1.4 As stated in Section 5.7 of Chapter 8 of the HKPSG, the principles of universal design should be adhered to in planning the public space and street environment so that all people including the elderly and disabled persons can have full access to all public facilities. The needs of the disabled should be integrated into design solution at the outset.

(i) Footpaths

Footpaths should be well maintained and free from obstacles. Railings, kerbs or tactile warning strips should be placed at the edge of the footpath where appropriate as a warning for the visually impaired. Long, steep grades should have level areas and/or benches at intermittent distances to provide rest areas for the elderly and disabled. Steep ramps and steps should be provided with handrails.

(ii) Street Furniture

Street furniture should have well defined bases for easy recognition by the blind. Spaces beneath footbridge ramps or stairway with low headroom, where it is not suitable for pedestrians to pass through, should be clearly defined and provided with landscaping features. High visual contrast should be used to maximise visibility for low-vision people.

(iii) Pedestrian Facilities

(a) Pedestrian crossings should be clearly marked with tactile warning strip for both the visually and physically impaired. Disabled crossing facilities including ramps or raised platforms, audible signals and obstruction-free routes should be provided. Ramps should be incorporated into pedestrian areas and footpaths/walkways where minor level change will occur, e.g. kerbs and piazzas.

(b) Major grade changes in footpaths/walkways should be avoided unless they are part of a comprehensively planned network. Lifts and ramps should be considered as part of grade-separated walkway systems.

8.2.2 Reasons for Provision of Barrier-free Facilities

- 8.2.2.1 It is stipulated in Section 26 of the Disability Discrimination Ordinance (Cap. 487) that facilities and services for the public including those relating to transport and travel should be accessible to people with disabilities. As the highway system and associated transport facilities provide the means for the community as a whole to pursue its day-to-day activities, it is essential to ensure that the requirements of the Ordinance is observed in the design and provision of these facilities.
- 8.2.2.2 Apart from those of people with disabilities, there is also increasing awareness of the needs and aspirations of people in other sectors. They at times require the same or similar facilities as people with disabilities. For example, high steps and steep slopes are difficult to negotiate by toddlers, elderly and people with physical handicap. The provision of accessible ramps and dropped kerbs is one of the ways to address their needs. It is essential to provide a barrier-free environment for all people in the community.
- 8.2.2.3 The provision of barrier-free highway and transport facilities also serves to ensure safety of all road users. For example, the provision of audible traffic signals at pedestrian crossings will help people with visual impairment and also other road users to recognise the change of traffic signals; and the provision of a barrier-free footway can help to reduce the number of cases in which pedestrians need to walk onto the carriageway and be exposed to the risk of traffic accidents. Every effort should be made to ensure road safety for the benefit of the whole community.
- 8.2.2.4 The additional cost to be incurred in the provision of barrier-free facilities is minimal. Therefore, cost alone may not be sufficient to seek exemption from the Disabilities Discrimination Ordinance.

8.2.3 Special Needs of People with Different Kinds of Disabilities

- 8.2.3.1 Disabilities are classified into eight major categories in Hong Kong, namely : autism, hearing impairment, mental handicap, mental illness, physical handicap, speech impairment, visceral disability and visual impairment.

8.2.3.2 The mobility challenge encountered by people with disabilities varies with the limitations caused by their disabilities. Designers must note their special needs and provide appropriate facilities to assist them in travelling safely and independently. To ensure that an environment is barrier-free to all, suitable compromise may need to be made under certain circumstances. Developers, planners and designers may consult the Rehabilitation Advisory Committee's Sub-committee on Access or individual disability organisation directly for more details. Information about key disability organisations is obtainable from the Commissioner for Rehabilitation and the Hong Kong Council of Social Service.

8.2.3.3 The following list is not exhaustive but can help illustrate the mobility challenges experienced by some people with disabilities :

(i) Wheelchair users

Staircases or escalators are tremendous obstacles for them. Therefore, gentle ramps should be provided at footbridges, subways and elevated walkways between buildings. If not permitted due to site constraints, provision of lifts should be considered. Non-slippery and level footway with sufficient width for the passage of a wheelchair would enable them to travel easily and safely. Dropped kerbs must be available at any crossings. Signal controlled crossing would always be of considerable assistance. Operation panels of any facilities should be located at a height reachable by them.

(ii) People using walking aids

They have difficulties in negotiating steps, walk relatively slowly and some may have limited body support ability. The provision of handrails, resting places at convenient locations and longer period of pedestrian phases at signal controlled crossings are necessary.

(iii) People with severe loss of sight

They rely heavily on their sense of hearing and touch. The provision of audible traffic signals, voice announcements, tactile guide paths and tactile warning strips are of great importance to them. The availability of Braille and tactile information could enable them to understand the surrounding environment better. Arrangement of street furniture in regular pattern could help to reduce their risk of hitting unexpected objects on the footway.

(iv) People with low vision

They have certain degree of residual vision and their needs are quite different from those of people with severe loss of eyesight. Raised letter without any colour contrast and Braille are useless to the majority of people with low vision. Facilities that can be seen (rather than touched) should be provided. Nosings of steps, signages and tactile guide paths should contrast visually with the surroundings. All signs should be erected at designated height with, preferably, larger print and high colour contrast. Good illumination level should be maintained in covered areas such as covered public transport interchange and under bridges.

(v) People with hearing impairment

The greater use of pedestrian phases at signal controlled crossings helps to ensure their safety in crossing the roads. Information panels providing useful messages are of great assistance to them as well.

8.2.3.4 Dimensions of wheelchairs and some basic design features catering for the needs of people with disabilities are provided in Diagrams 8.2.3.1 and 8.2.3.2 respectively.

DIAGRAM 8.2.3.1 : DIMENSIONS OF WHEELCHAIRS

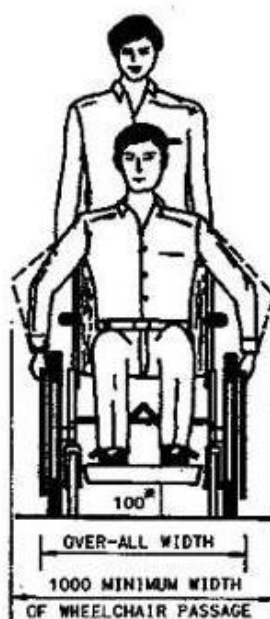
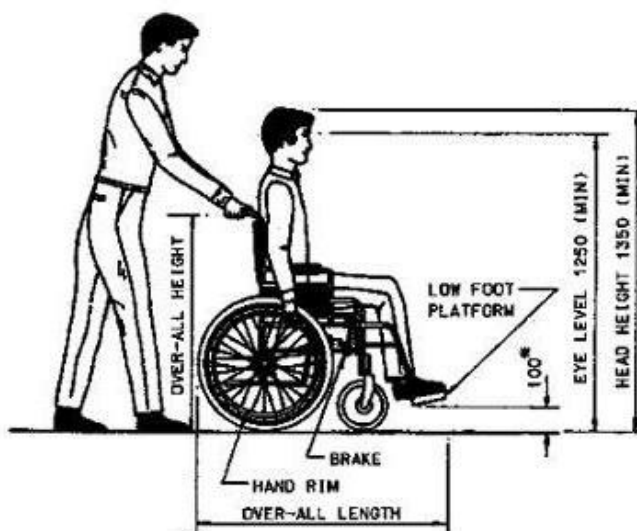

<u>Type of Wheelchair</u>	<u>Over-all Width(mm)</u>	<u>Over-all Length(mm)</u>	<u>Over-all Height(mm)</u>	<u>Weight of Wheelchairs(lb)</u>	<u>Frame Width of Wheelchairs(not including the Wheels) (mm)</u>
(1) Manual Wheelchair	510 - 725	865 - 1100	850 - 1400	23 - 59	400 - 510
(2) Electric Wheelchair	520 - 700	1050 - 1200	1010 - 1400	80 - 220	400 - 500

NOTES:

(1) ALL DIMENSIONS ARE IN MILLIMETRES.

(2) *100mm VERTICAL CLEARANCE SHOULD BE MAINTAINED TO ALLOW WHEELCHAIRS HAVING LOW FOOT PLATFORM OR BATTERY (FOR ELECTRIC WHEELCHAIR) TO PASS.

DIAGRAM 8.2.3.2 : BASIC DESIGN FEATURES CATERING FOR THE NEEDS OF PEOPLE WITH DISABILITIES

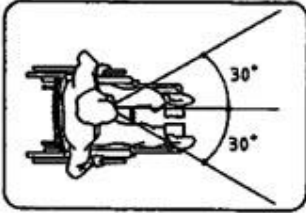

FIELD OF VISION FOR WHEELCHAIR USERS

MINIMUM DESIRABLE WIDTH FOR RAMPS, WALKWAYS, SUBWAYS ETC. TO BE USED BY WHEELCHAIR USERS.

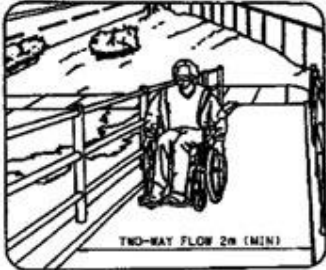

TWO-WAY FLOW 2m (MIN)



2m MINIMUM CLEAR HEADROOM OVER FULL WIDTH OF FOOTWAY

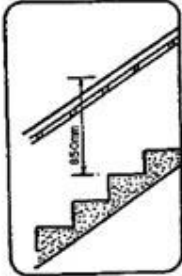

HANDRAILS ABOVE STEPS NEED TO BE AT A LOWER HEIGHT THAN IN RESPECT OF LEVEL SURFACES.

8.3 Planning for People with Disabilities

8.3.1 General

- 8.3.1.1 The Buildings Ordinance (Cap 123) and relevant regulations stipulate the minimum requirements of providing access and facilities in buildings for people with disabilities. These obligatory requirements and some recommended requirements are set out in the Design Manual : Barrier Free Access 2008.
- 8.3.1.2 To obtain full advantage of the accessible facilities provided in buildings, the surrounding areas must be equally accessible.
- 8.3.1.3 Consideration should be given to the adaptation of existing areas, to provide accessible facilities as far as feasible. As for the planning of new developments only a little more attention to detail by the designer can transform an area of limited accessibility to one providing relatively free mobility for people with disabilities.
- 8.3.1.4 Whilst the provision of an isolated accessible facility can offer assistance to people with disabilities in a particular location, its value is considerably diminished if there is an obstacle nearby preventing people with disabilities from reaching that facility or continuing the journey. Therefore, the designer must examine not only individual locations but also endeavour to create a barrier-free area for people with disabilities through which they can travel with relative freedom. Disability organisations concerned should be consulted wherever necessary to achieve a design that can meet the desire of people with disabilities and others.

8.3.2 Accessible Facilities along Barrier-free Routes

- 8.3.2.1 The following design should be adopted in providing accessible facilities along barrier-free routes:
- (i) The width of all footways should not be less than 2 m and preferably wider.
 - (ii) Dropped kerbs should be available at all at grade crossing point.
 - (iii) Grade separated crossing points should have lifts or ramps of gradients not steeper than 1:12. Steeper gradient of up to 1:10 may be used if space is limited.
 - (iv) If topography permits, routes should be chosen which follow footways with longitudinal gradients not steeper than 1:12.
 - (v) Signal controlled crossing should be equipped with audible signals. For details, refer to Section 3.2.4 of Volume 4 Chapter 3.
 - (vi) Ramps/lifts should be provided as alternative to steps and staircases.
 - (vii) Street furniture should be regularly arranged and should not obstruct the passage.
 - (viii) Proper signage should be provided.
- 8.3.2.2 Specifications of each facility are listed in latter paragraphs of this chapter.

- 8.3.2.3 In existing urban areas, modification is in progress to improve the condition of routes so that they can become more accessible. Accessible facilities should be provided within 400 m along routes leading to the following areas in particular:
- (i) Major business or commercial areas, shopping streets and large shopping arcades
 - (ii) Public transport interchange and terminus, and particularly the following:
 - (a) franchised bus terminus
 - (b) public light bus (PLB) stands
 - (c) taxi stands
 - (d) Kowloon-Canton Railway (KCR) stations
 - (e) Mass Transit Railway (MTR) stations
 - (f) Light Railway Transit (LRT) stations
 - (g) tram platforms
 - (h) ferry piers
 - (i) airport
 - (iii) Government Offices and buildings of public interest, to which the general public normally require access, e.g. Post Offices, Inland Revenue Offices, Police Stations, sport and cultural centres, etc.
 - (iv) Markets
 - (v) Hospitals and clinics
 - (vi) Any building particularly provided for people with disabilities, e.g. rehabilitation centres, workshops, etc.
 - (vii) Car parking spaces particularly provided for drivers with disabilities
 - (viii) Residential estates
 - (ix) Parks, open spaces, etc.
- 8.3.2.4 Any projections by footbridges or other structures over the footway should have at least 2 m vertical clearance between the footway and the lowermost part of the structure. If for any reason this cannot be provided, then planters or similar, as shown in Diagram 8.3.2.1, should be positioned to prevent pedestrians and particularly people with visual impairment from walking into these projections.
- 8.3.2.5 Where planting is provided adjacent to the footway, regular maintenance is essential to ensure branches of trees or shrubs do not overhang footways or paths, as not only do these present a particular danger to people with visual impairment, they may also reduce the effective footway width available to pedestrians.

**DIAGRAM 8.3.2.1 : USE OF PLANTERS BENEATH CANTILEVERED STAIRS OR
SIMILAR**

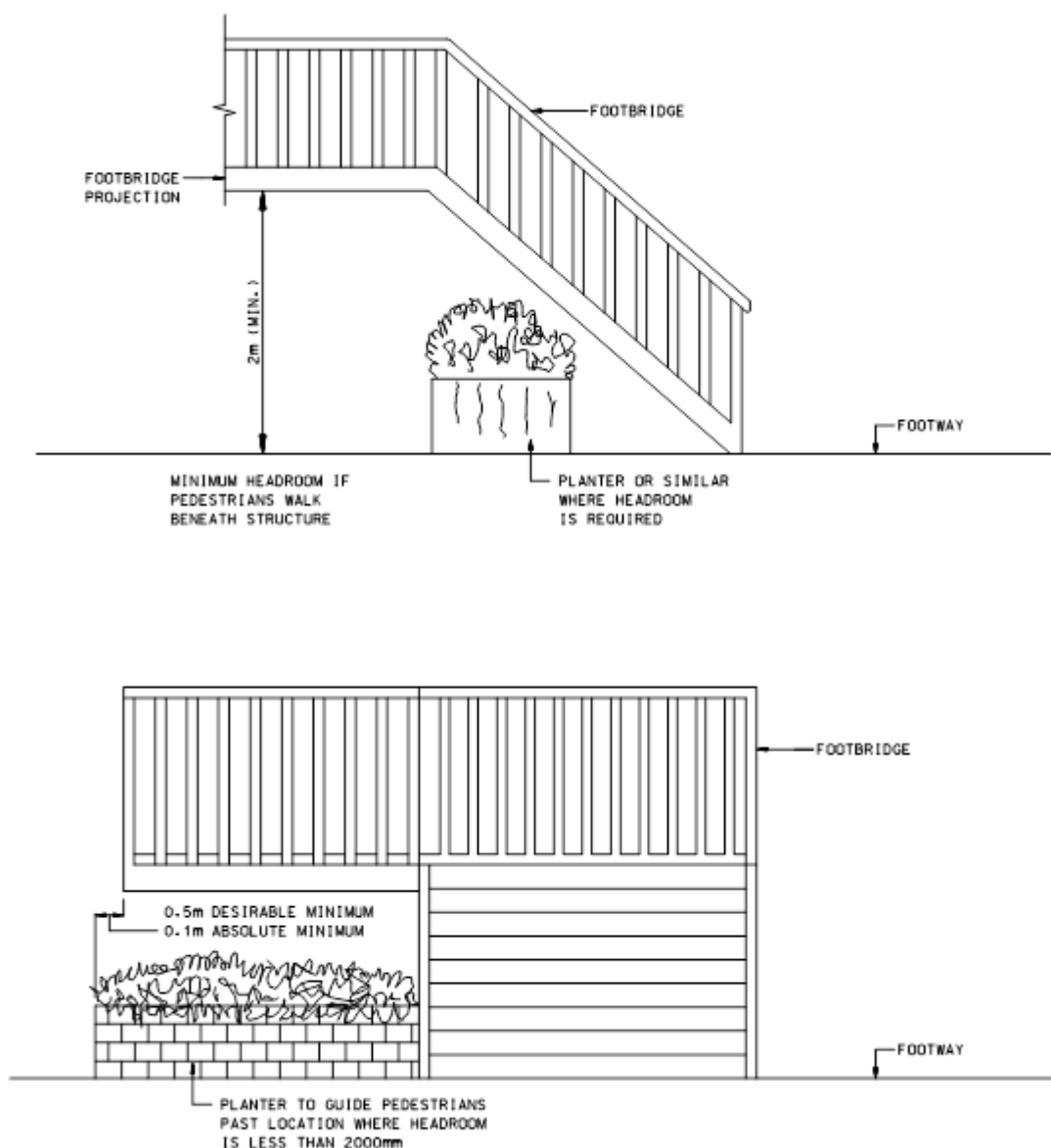

8.3.3 Provision and Design of Tactile Guide Path

- 8.3.3.1 People with visual impairment may become disorientated in open spaces. It would be much helpful to them if defined edges could be provided on footways by means of planters with dwarf walls, a grass verge, etc. as shown in Diagram 8.3.3.1 to indicate the direction to follow.
- 8.3.3.2 Traditional cues such as kerb edges and building lines may provide the cue for guiding people with visual impairment along a route. However, in large vacant spaces whereby the cue of physical edges is not present, tactile guide paths may be used to facilitate orientation of people with visual impairment. The provision of tactile guide path can also guide people with visual impairment between two destinations. In case that there are existing tactile guide paths in the vicinity, consideration shall be given to connect them with the new provision whenever feasible.

8.3.3.3 For footbridge and subway systems with multiple ingress and egress points including accesses, stairs, lifts and etc, large vacant spaces are in fact created at some connection points or intersection of spans across different roads, where people with visual impairment may be disorientated. The tactile guide path should be considered as described in Paragraph 8.3.3.2.

8.3.3.4 The provision of tactile guide paths should be considered if all of the following criteria are satisfied:

- (i) Distance
The distance between the target service institutions for people with visual impairment (e.g. centres, offices, regional hospitals, eye clinics, workshops, major government offices that provide or will provide services for people with visual impairment and other locations where people with visual impairment frequently visit) and nearest public transport facilities (e.g. public transport interchanges, railway/MTR stations, bus termini or ferry piers) is within 400m;
- (ii) Open Space
Tactile guide path should be provided at large vacant space as mentioned in Paragraphs 8.3.3.2 and 8.3.3.3 where people with visual impairment may become disorientated or lose their direction sense;
- (iii) Demand Assessment
Assessment should be carried out to ascertain that the target service institutions which tactile guide paths are leading to are visited or will be visited regularly by people with visual impairment; and
- (iv) Engineering Assessment
Assessments on traffic engineering aspects (e.g. alignment etc.) and technical feasibility (e.g. adequate thickness of the existing floor finishes to accommodate the tactile blocks/tiles, etc.) of the proposed tactile guide path routes should be carried out.

8.3.3.5 For existing footbridge and subway systems, the tactile guide paths will be installed upon receipt of formal requests from the public or the disabled organisations subject to satisfaction of all the criteria specified in Paragraph 8.3.3.4. In case of substantial public requests received and resource limitation from the Highways Department, the implementation of provision of tactile guide path should be phased out in the following order of priority:

Table 8.3.3.1
Priority of provision of tactile guide path on existing footbridge and subway systems

Priority	Target Destination for linking to public transport facilities
1	Centres/offices providing services for the people with visual impairment
2	Regional Hospitals and eye clinics
3	Workshops providing services for people with visual impairment
4	Major Government offices providing services for members of the public
5	Other locations where people with visual impairment frequently visit

8.3.3.6 In designing the tactile guide path, the concerned organisations representing people with disabilities should be consulted wherever necessary so as to achieve a design, including the colour contrast, extent, alignments and positioning of proposed tactile guide paths, so that the proposed tactile guide path can meet their actual needs of people with visual impairment.

8.3.3.7

Three kinds of tactile tiles/blocks as shown in Diagram 8.3.3.2 are commonly used in constructing a tactile guide path:

- (i) Directional Tile/Block
This has parallel raised bars for guiding the users along an intended safe path.
- (ii) Hazard Warning Tile/Block
This has raised big dots (35mm in diameter) arranged in square grid parallel to the sides of the slab for indication of potential hazards ahead. This type of tile/block could be used alone to form tactile warning strips at the top and bottom of staircase or ramps, and at dropped kerbs.
- (iii) Positional Tile/Block
This has raised small dots (23mm in diameter) placed in staggered positions for indication of possible change in walking directions.

For proprietary products having patterns and dimensions slightly deviated from those shown, approval should be sought for using such material from the Road Safety and Standards Division of the Transport Department.

DIAGRAM 8.3.3.1 : EDGE OF FOOTWAY TREATMENT



GRASSED AREA USED
TO DEFINE EDGE
OF FOOTWAY

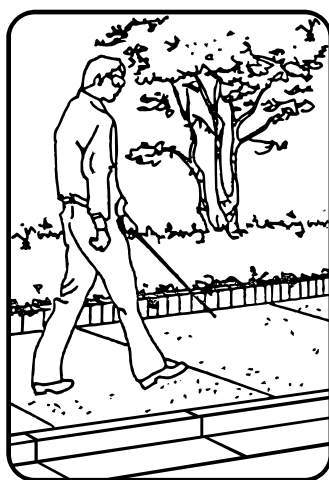

PLANTERS USED
TO DEFINE EDGE
OF FOOTWAY

DIAGRAM 8.3.3.2 : DETAILS OF TACTILE WARNING TILES / BLOCKS

POSITIONAL TILE/BLOCK

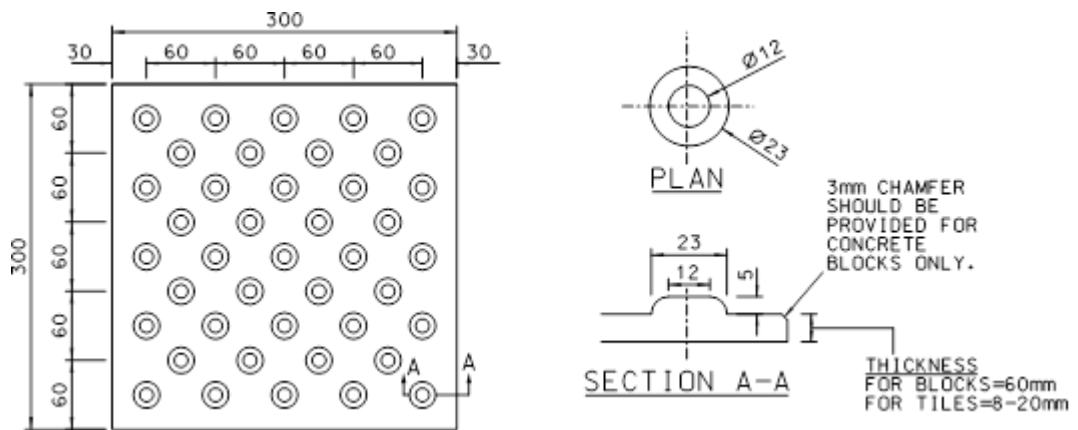

DIRECTIONAL TILE/BLOCK

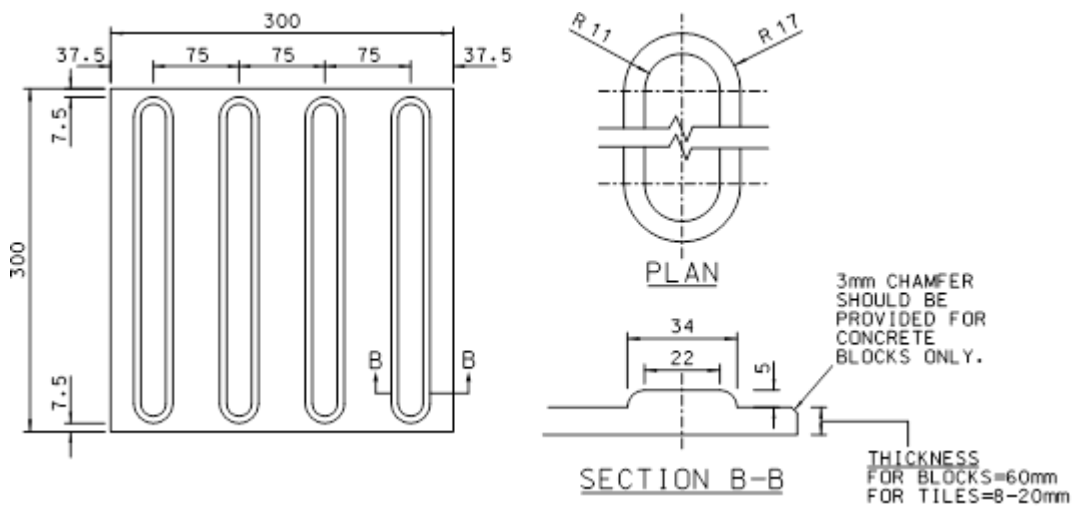

HAZARD WARNING TILE/BLOCK

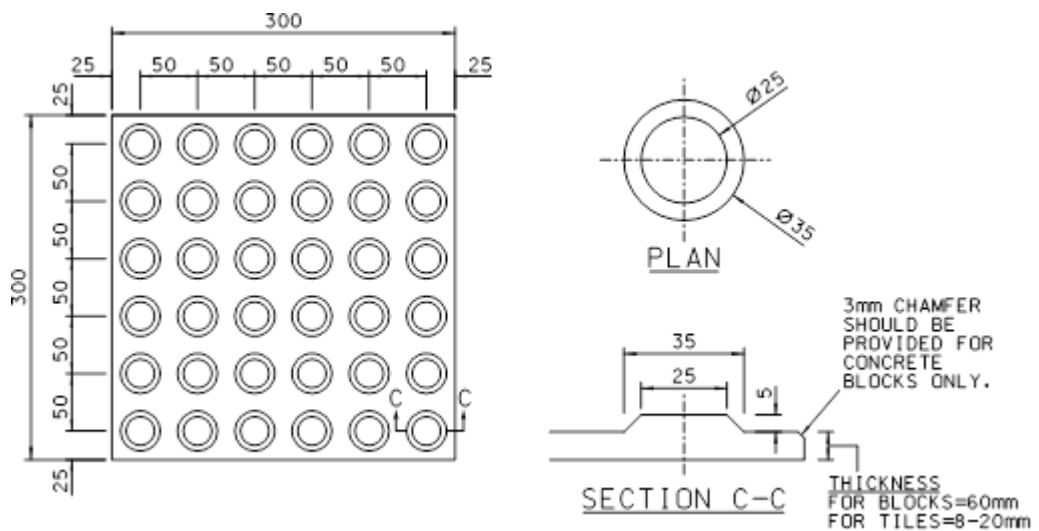

ALL DIMENSIONS ARE IN MILLIMETRES

- 8.3.3.8 Tactile tiles/blocks of 300mm x 300mm are used for illustration in this Chapter. Other dimensions e.g. 100mm x 200mm may also be used in constructing tactile warning strips or guide paths provided that the patterns so formed should conform to the basic patterns illustrated in Diagrams 8.3.3.3 to 8.3.3.7.
- 8.3.3.9 Tactile tiles/blocks should be made of durable and non-slippery materials complying with the Highways Department's relevant strength and slip resistance requirements. Besides, its colour should contrast visually with the adjoining surfaces (e.g. yellow tactile tiles/blocks on grey/red footway, light-on-dark, dark-on-light, etc.) to provide clear indication of the routes to people with low vision. In case of doubt, it is advisable that the concerned organisations for the people with disabilities should be consulted on the visual contrast. Having established visual contrasting combinations which are acceptable to this group, any one of the combinations could be used in a specific project.
- 8.3.3.10 Tactile guide paths are useful to guide people with visual impairment in a safe way to specified destinations. Diagrams 8.3.3.3 to 8.3.3.7 show typical arrangements of the guide path at different situations. Particular attention should be drawn to the provision of positional tiles/blocks at the intersection of directional tiles/blocks and hazard warning strip.
- 8.3.3.11 Appropriate tactile tiles/blocks should be provided at correct positions to advise people with visual impairment to take appropriate actions. It is desirable to position the guide path as close to the building or back of footway as possible to minimise interference with other pedestrians. To avoid conflict with any existing obstruction located adjacent to a building, the guide path can be set out in a flexible range of 450 to 1000mm from the building line or edge of footway, footbridge or subway as illustrated in Diagrams 8.3.3.6 to 8.3.3.7.
- 8.3.3.12 Tactile guide path along the directional tiles/blocks should as far as possible be straight. Turning of direction of tactile guide path can be done by the use of tiles/blocks at junction as shown in Diagram 8.3.3.3. For turning angle greater than 45° but not more than 90°, please refer to Diagram 8.3.3.3(ii). Cumulative turning angle not greater than 45° with turning angle with adjacent block not greater than 15° is acceptable to avoid too many turning with tiles/blocks at junction as shown in Diagram 8.3.3.3(iii).
- 8.3.3.13 Audible traffic light signal should be provided at the crossing to ensure the safety of people with visual impairment to cross the carriageway. For details, refer to Section 3.2.4 of Volume 4 Chapter 3. Also, the directional tiles/blocks should meet the warning strip at a position near the traffic light post to enable people with visual impairment to press any push button without difficulty.

8.3.3.14 There is enormous difficulty in providing the tactile guide path continuously and maintaining it in good conditions because:

- (i) Excavation of footways for maintenance or provision of new utility services requires constant removal of tiles/blocks during which damage to the tiles/blocks may occur. The reinstatement works may last longer when the tactile tiles/blocks were not available;
- (ii) Manhole and service covers are often located on footways where crossing points occur. The provision of a continuous tactile warning strip or guide path requires the cooperation of utility undertakers in the provision and maintenance of matched tactile patterns on recessed covers; and
- (iii) Bollards are occasionally encountered at pedestrian crossing or footway to prevent illegal hawkers or parking. To prevent people with visual impairment from stumbling, the existing bollards should desirably be removed or relocated so that the passage of the guide path is free of obstruction. If the bollards on the pedestrian crossing cannot be removed due to whatever reason, the bollards should, if possible, be set back to 300mm (desirable) or 100mm (absolute) behind the proposed tactile strip location.

DIAGRAM 8.3.3.3 : TYPICAL TACTILE GUIDE PATH JUNCTION

(i) Intersection with hazard warning strips

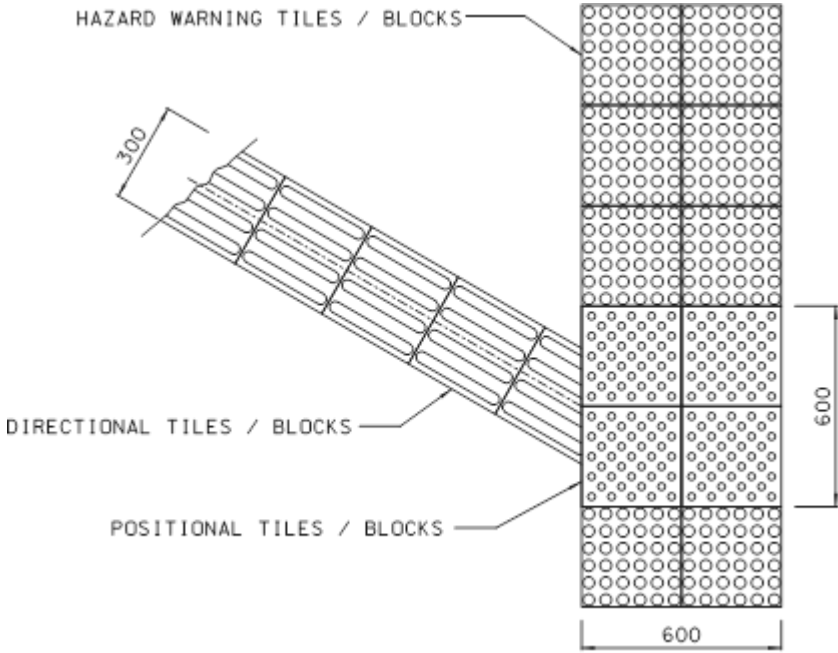

(ii) Turning angle greater than 45°, by the use of tiles/blocks at junction

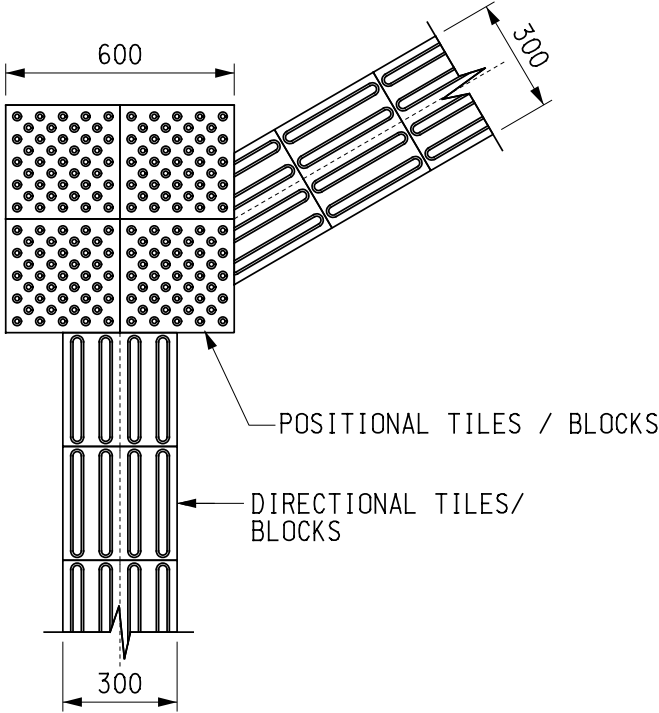

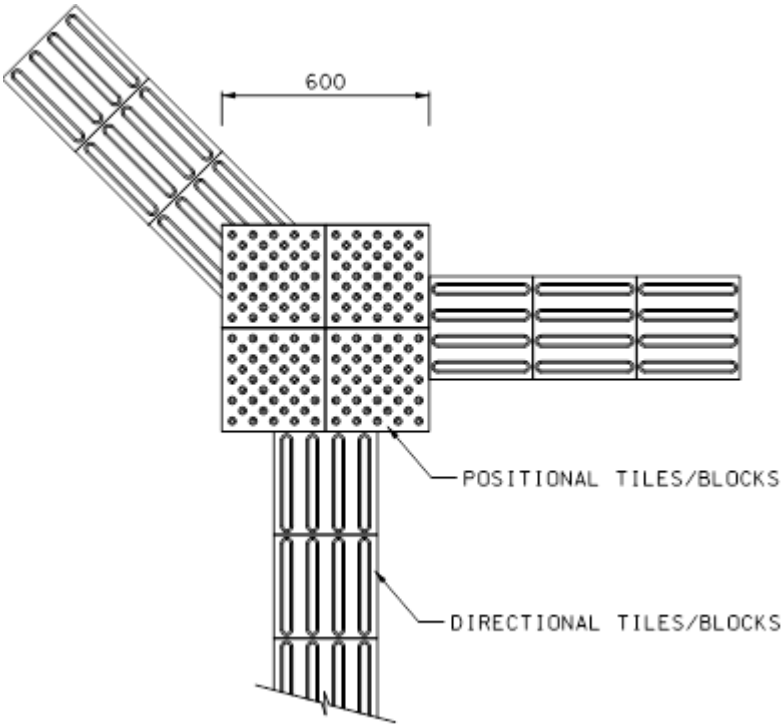

(iii) Turning angle not greater than 45°, by modifying the directional tiles / blocks

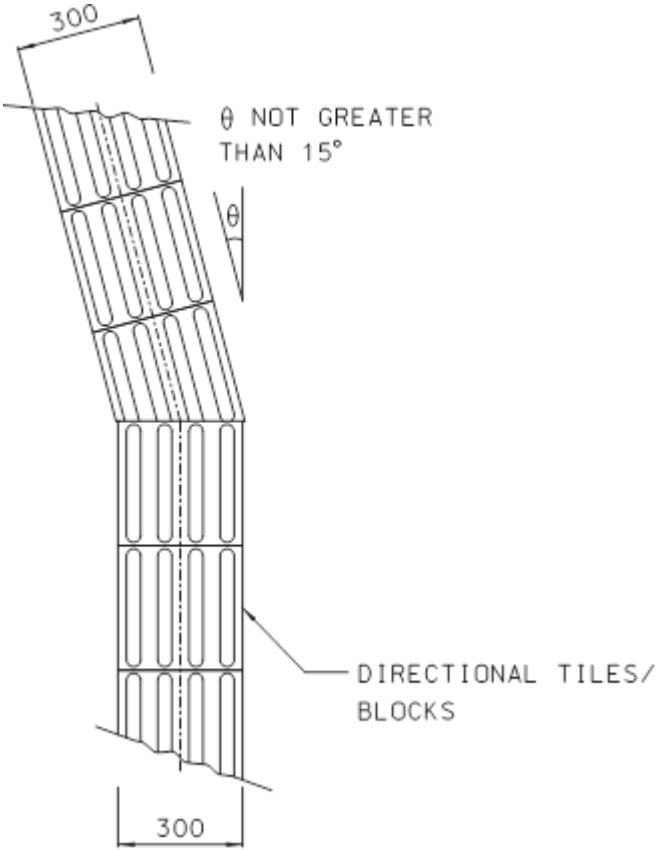

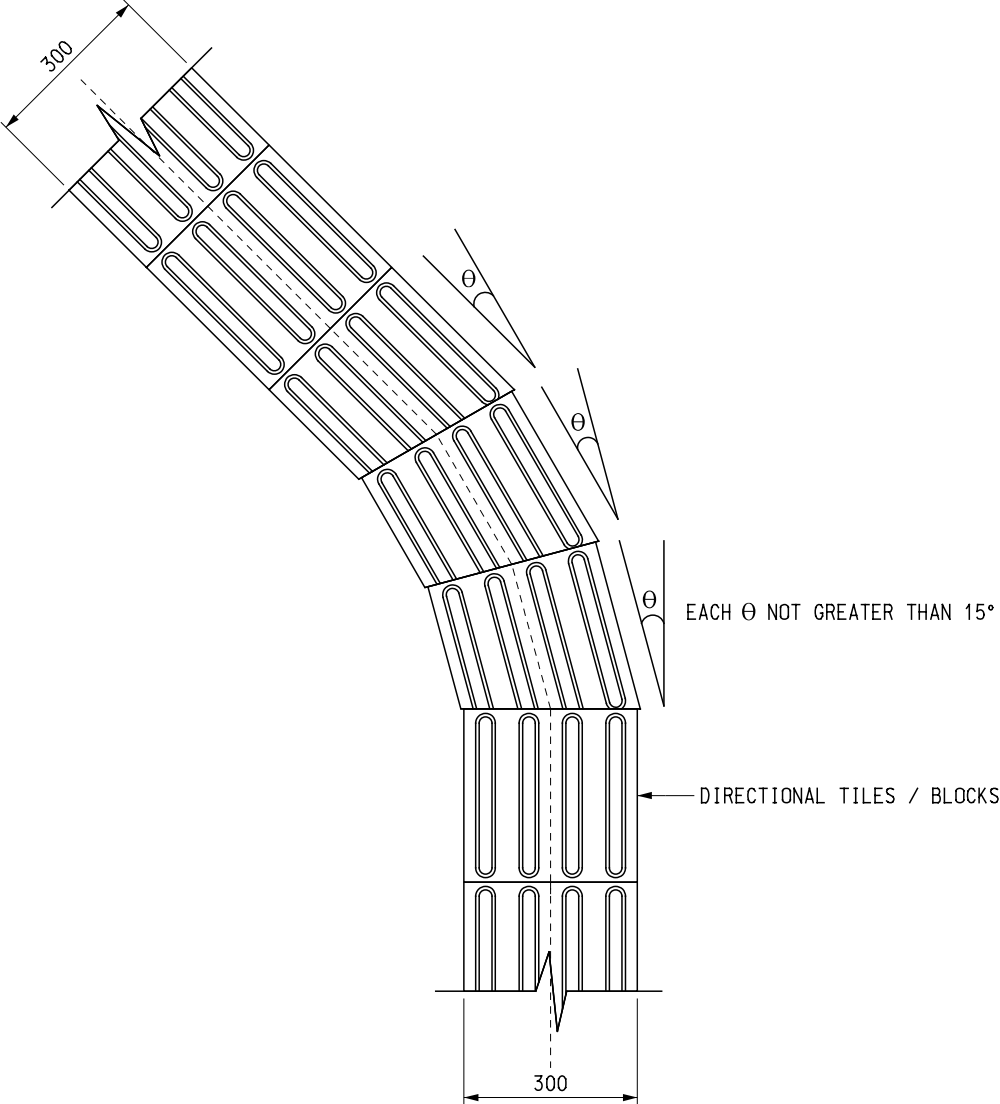

ALL DIMENSIONS ARE IN MILLIMETRES

DIAGRAM 8.3.3.4 : TACTILE WARNING STRIP AT BUILDING ENTRANCE / EXIT

TACTILE WARNING STRIP AT BUILDING ENTRANCE / EXIT WITH PUSH-OUT DOORS

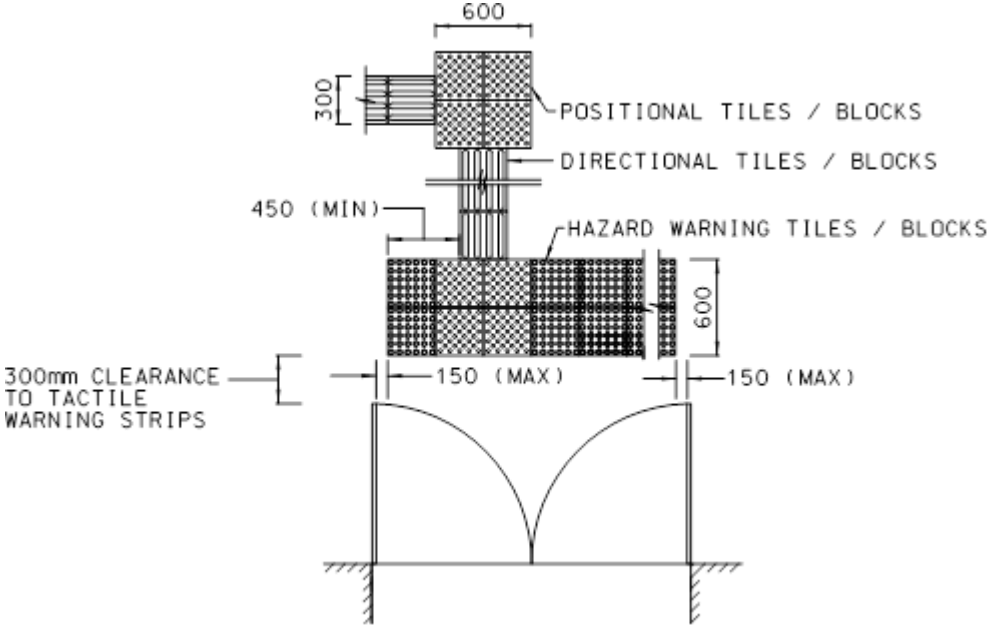

TACTILE WARNINGS STRIP AT BUILDING ENTRANCE / EXIT

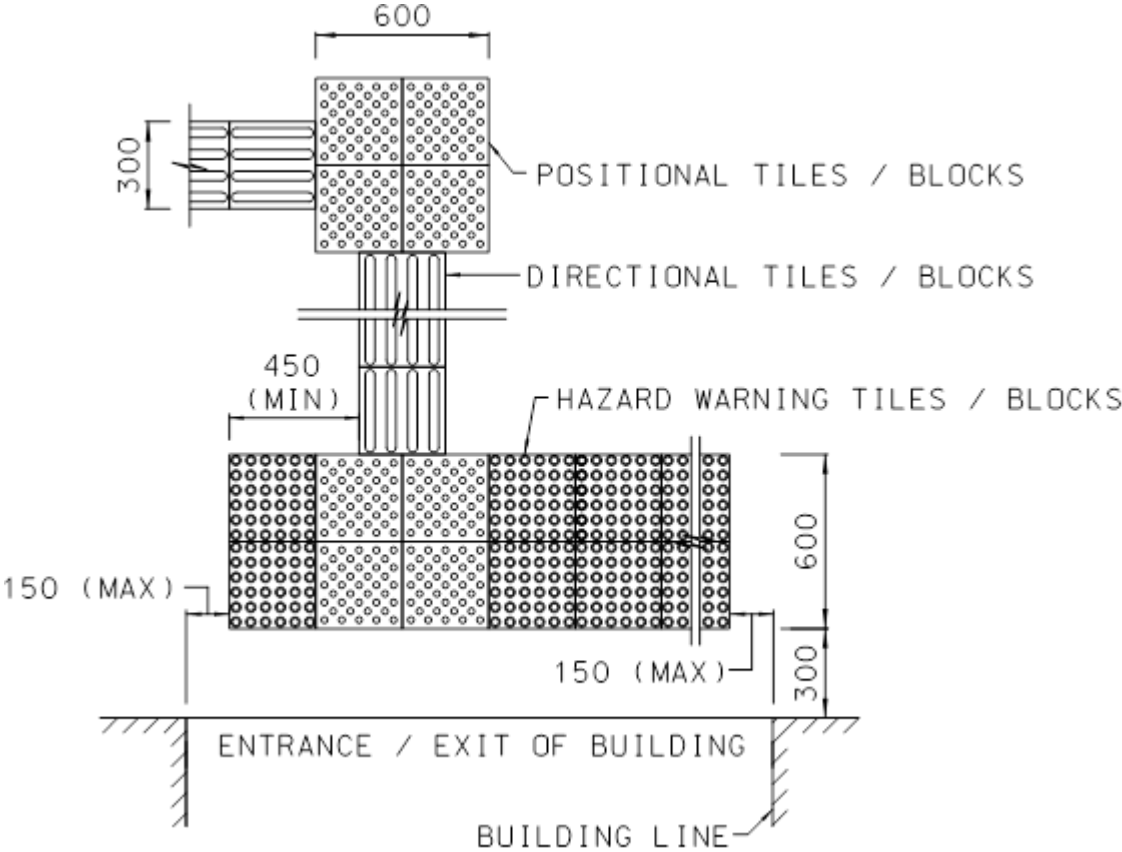

ALL DIMENSIONS ARE IN MILLIMETRES

DIAGRAM 8.3.3.5 : TACTILE GUIDE PATH LEADING TO LIFT ENTRANCE

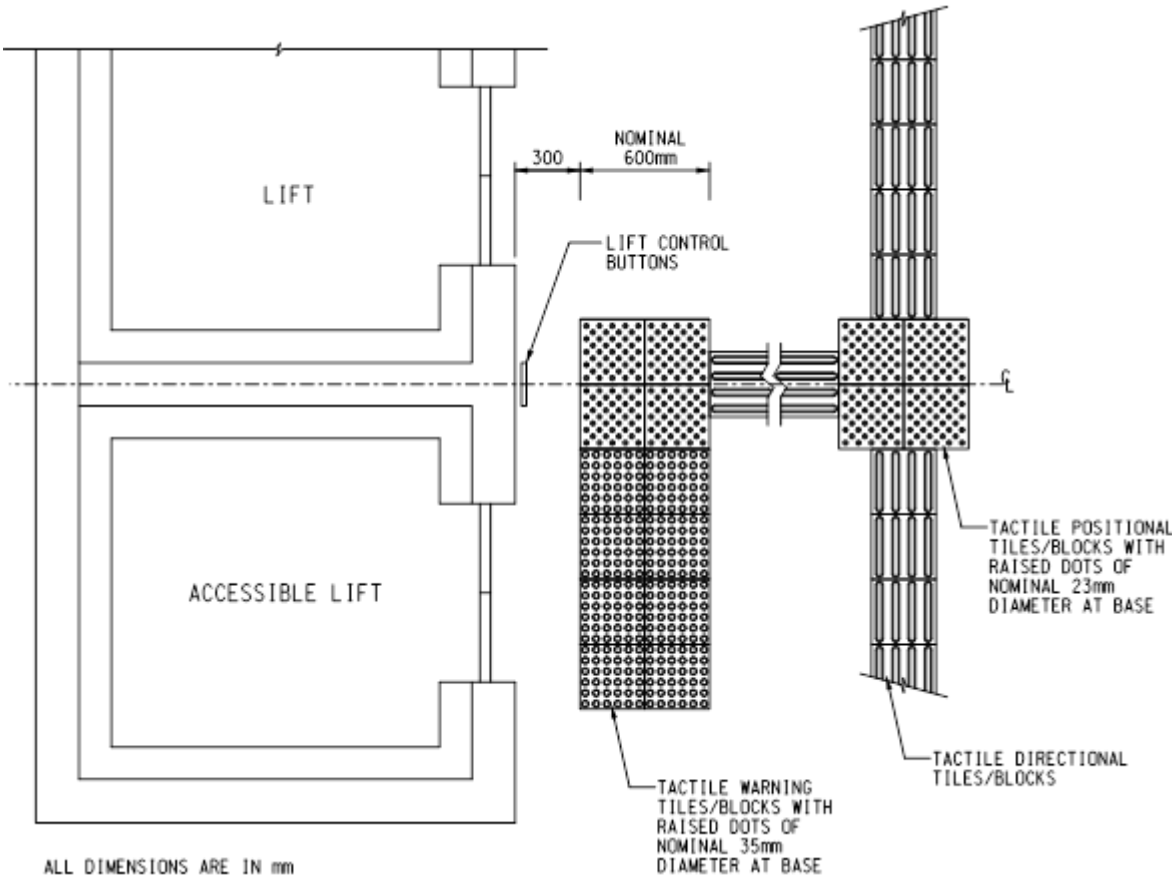

TACTILE GUIDE PATH TO LIFT ZONE

ALL DIMENSIONS ARE IN MILLIMETRES

DIAGRAM 8.3.3.6 : TACTILE GUIDE PATH LEADING TO PEDESTRIAN CROSSING

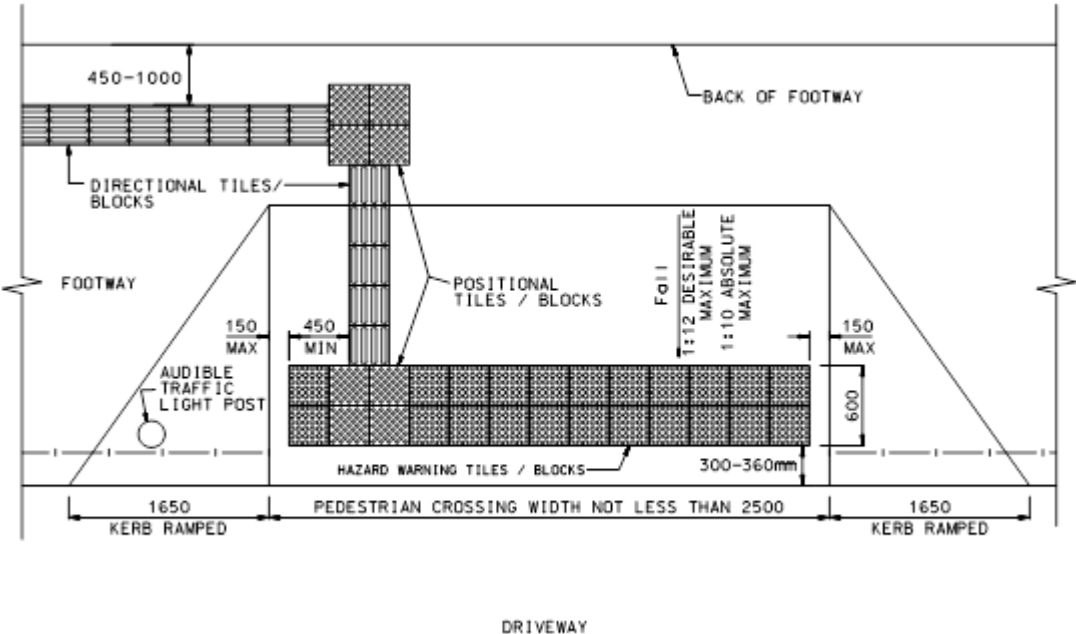

ALL DIMENSIONS ARE IN MILLIMETRES

DIAGRAM 8.3.3.7 : TACTILE GUIDE PATH AT RUN-IN

ROAD WITHOUT ROADSIDE RAILING

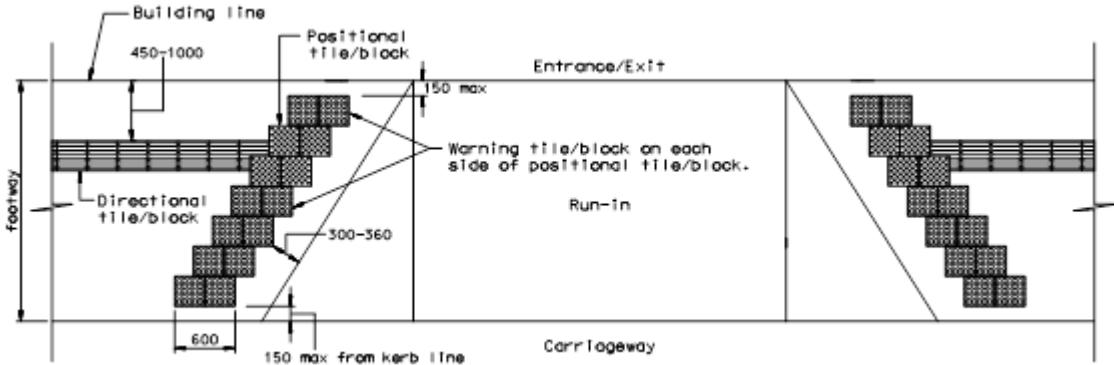

ROAD WITH ROADSIDE RAILING

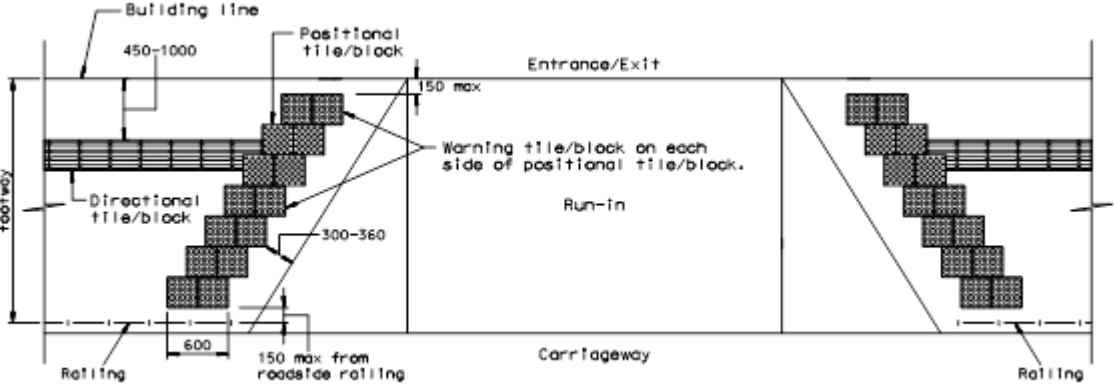

ALL DIMENSIONS ARE IN MILLIMETRES

8.4 Crossing Facilities for People with Disabilities

8.4.1 General

- 8.4.1.1 The different special needs of people with disabilities may affect their mobility. Whilst it is not possible to remove all of the obstacles for people with disabilities, the designer can and should, make crossing the road much easier for them by removing or reducing the effects of some of the more obvious obstacles.
- 8.4.1.2 Design details for crossings are contained in Volume 2 and Volume 4, and should be followed. The objective of this section is to provide additional information which the designer should wherever possible consider and include in the design of pedestrian crossing places, in order that they can be more fully utilised by people with disabilities.

8.4.2 Crossing Locations and Approaches

- 8.4.2.1 Attention should be given to the following in the design of crossings:
- (i) In order to reduce the exposure time to vehicular traffic, all at-grade crossing should be:
 - (a) as near perpendicular to the carriageway as possible;
 - (b) located at the narrowest most convenient part of the carriageway; and
 - (c) provided with central refuges as mid-crossing shelters if the width of carriageways to be crossed exceeds 10m. As indicated in Diagram 8.4.2.1, the central refuges should be at least 1.5m deep and 2.5m wide. It is desirable that these are also provided where the carriageway width is 6m or more, though this may require local widening of the carriageway.
 - (ii) All crossings should be located close if not contiguous with the normal pedestrian desire line.
 - (iii) The location should be such that a simple and uncomplicated crossing layout can be achieved.
 - (iv) Proper and direct crossing should be provided to divert from one footway to another through carriageway.
- 8.4.2.2 On the immediate approach to all at-grade crossings, 15mm high dropped kerbs with ramps should be provided across the full width of the crossing.
- 8.4.2.3 In some countries tactile warning strips of one form or another are provided in the immediate vicinity of crossings to alert people with visual impairment of potential hazard ahead. The provision of tactile warning strips at crossings as well as central refuges and safety islands are illustrated in Diagrams 8.4.2.2 to 8.4.2.7. Detailed design of the tactile tiles/blocks is provided in Section 8.3.2.

DIAGRAM 8.4.2.1 : CENTRAL REFUGE

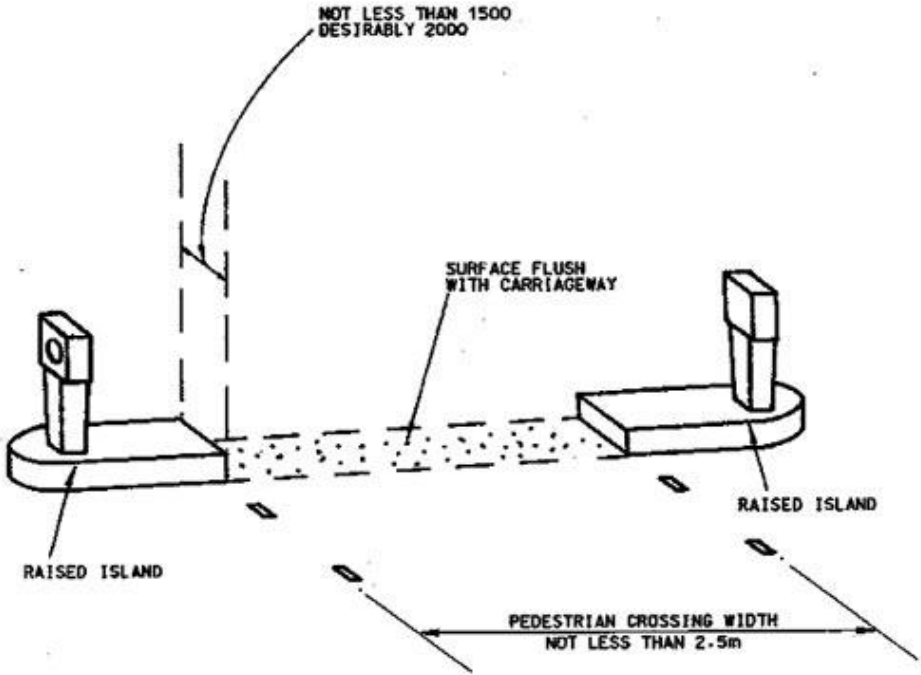

ALL DIMENSIONS ARE IN MILLIMETRES EXCEPT OTHERWISE STATED.

DIAGRAM 8.4.2.2 : TACTILE WARNING STRIP AT PEDESTRIAN CROSSING

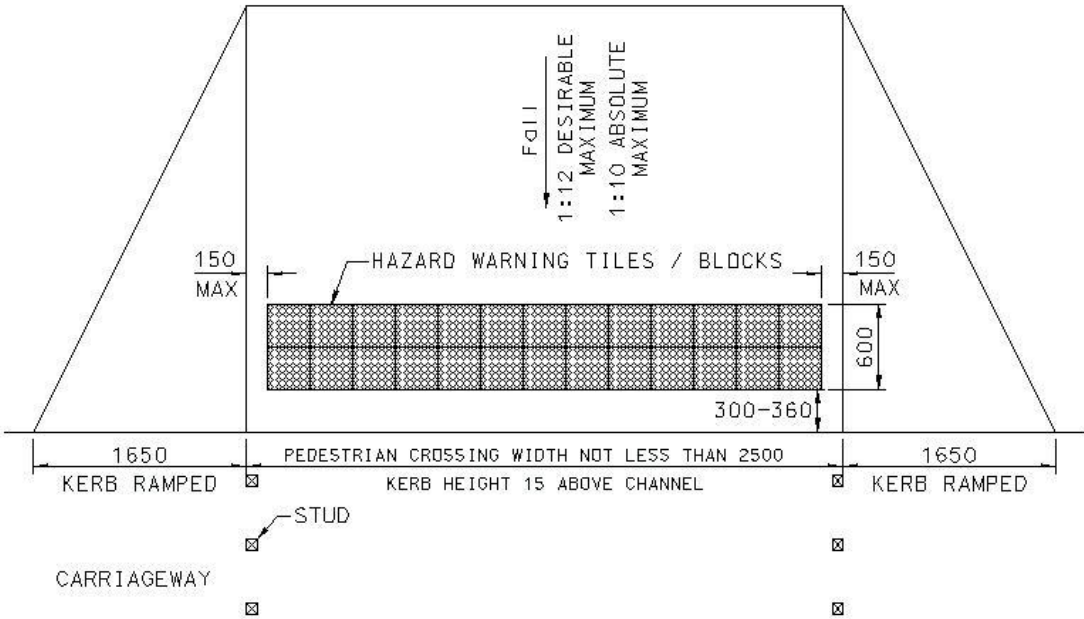

ALL DIMENSIONS ARE IN MILLIMETRES

DIAGRAM 8.4.2.3 : TACTILE WARNING STRIP AT SKEWED CROSSING

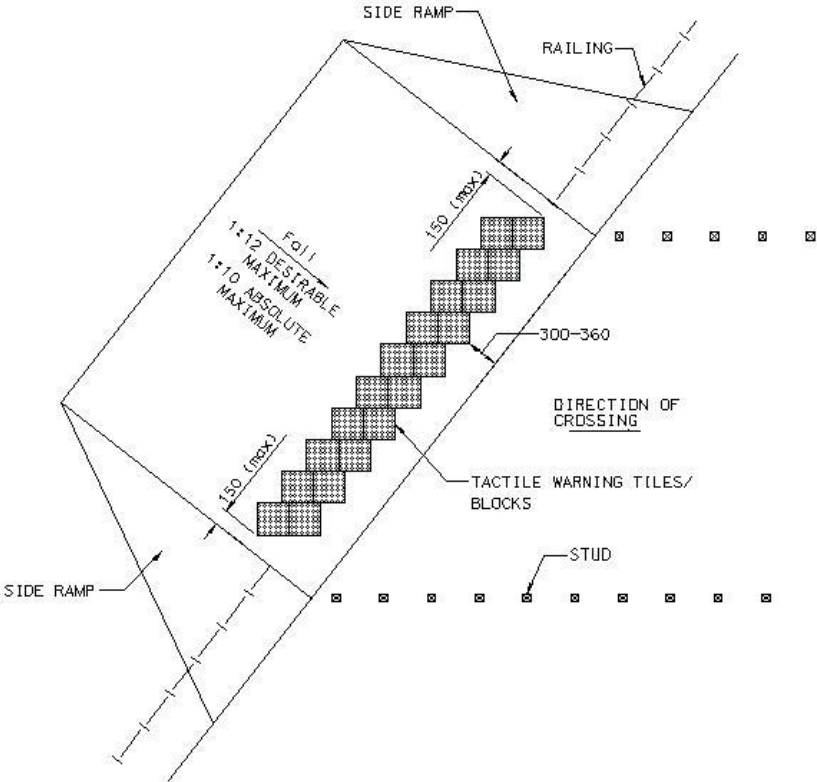

ALL DIMENSIONS ARE IN MILLIMETRES

DIAGRAM 8.4.2.4 : TACTILE WARNING STRIP AT PEDESTRIAN CROSSING TO ONE SIDE ONLY AT STREET CORNER

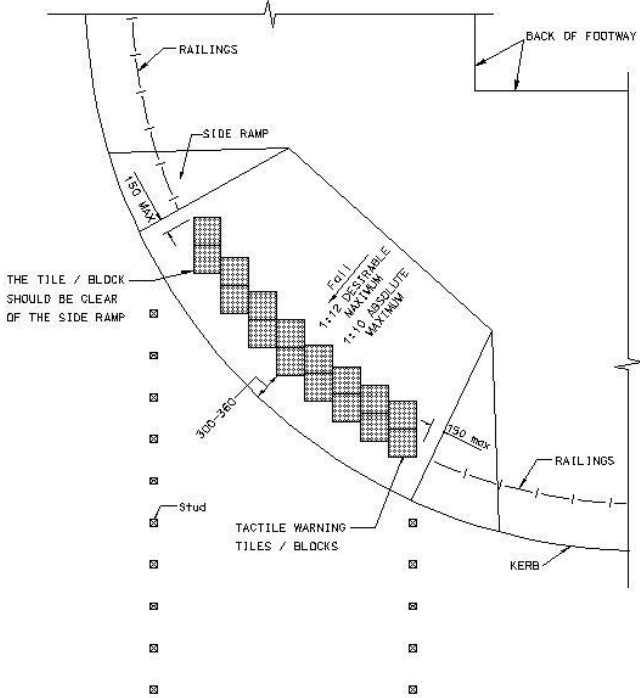

ALL DIMENSIONS ARE IN MILLIMETRES

DIAGRAM 8.4.2.5 : TACTILE WARNING STRIPS AT TRIANGULAR SAFETY ISLAND

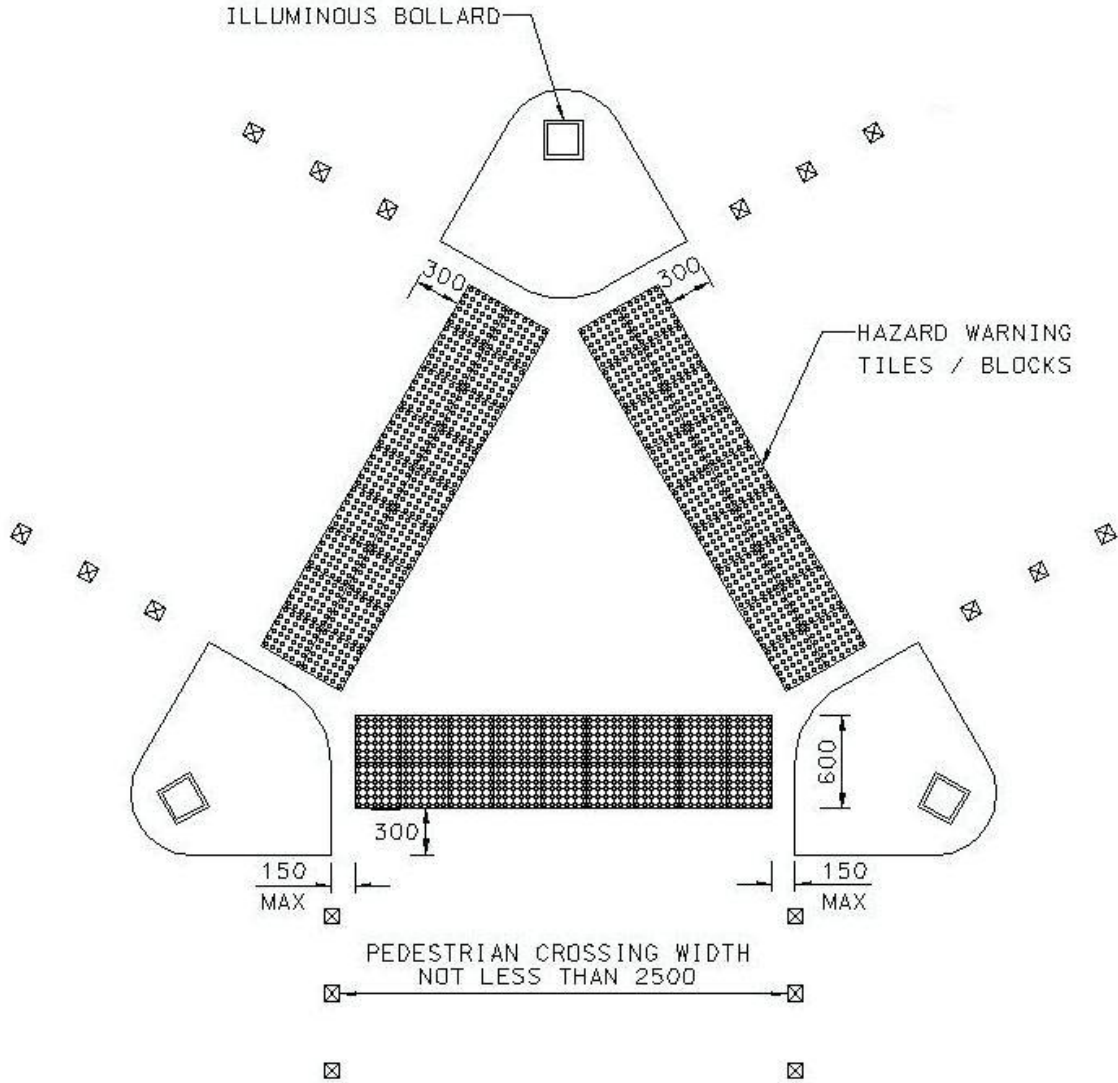

ALL DIMENSIONS ARE IN MILLIMETRES

DIAGRAM 8.4.2.6 : TACTILE WARNING STRIPS AT STAGGERED CROSSING

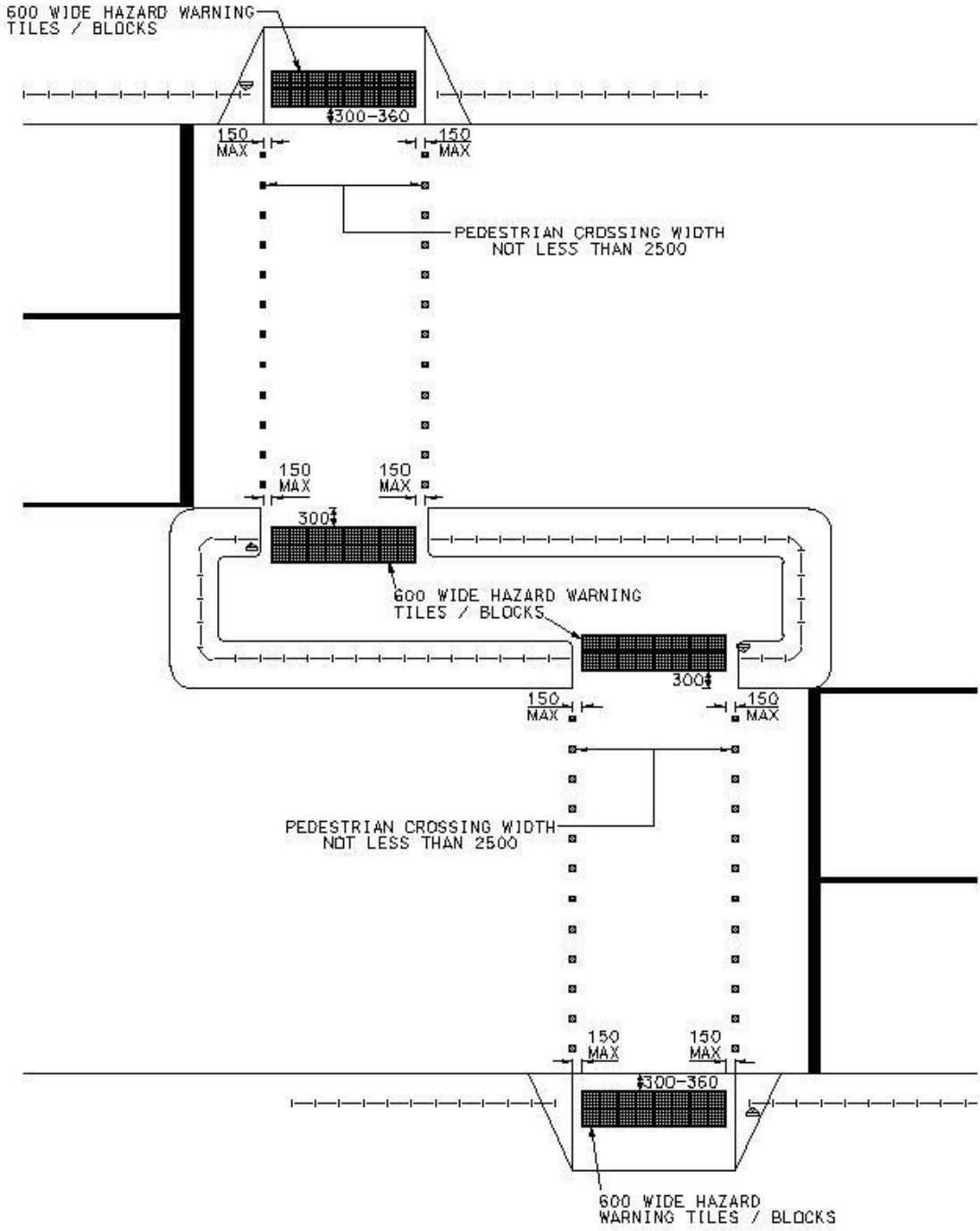

ALL DIMENSIONS ARE IN MILLIMETRES

DIAGRAM 8.4.2.7 : TACTILE WARNING STRIPS AT CENTRAL REFUGES
TACTILE WARNING STRIPS AT CENTRAL REFUGE (DEPTH < 1.80m)

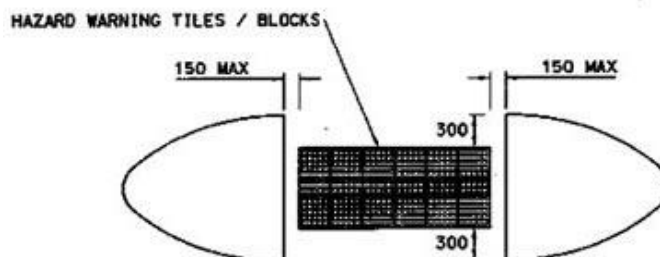

TACTILE WARNING STRIPS AT CENTRAL REFUGE (DEPTH ≥ 1.80m)

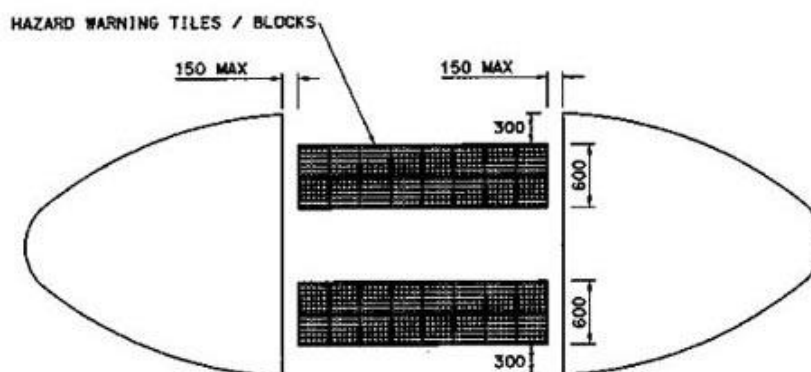

ALL DIMENSIONS ARE IN MILLIMETRES

8.4.3 Types of Crossing

- 8.4.3.1 The most beneficial form of crossing for any people with disabilities is the signal controlled crossing having pedestrian phases and audible signals, which should be provided in preference to other types of crossings wherever possible.
- 8.4.3.2 Light signal controlled crossing provides a level surface for crossing a road, without any major detour. Additionally, they have a protected phase so that people with disabilities are not unnecessarily concerned about any vehicles driving across their path during the time the crossing phase is operating. The audible signals provide not only assistance to people with visual impairment in respect of when to cross, but also further assurance to other people with disabilities. The audible signal also assists in locating where the crossing is.
- 8.4.3.3 One disadvantage of these types of crossings in the territory is the comparatively short period allowed for the crossing time. Whilst it is realised that a compromise has to be reached between the demands of the pedestrians and that of vehicular traffic, it has often been found that periods allowed do not provide sufficient time for the slower moving people with disabilities. In this respect the provision of central refuges can reduce the distance that needs to be travelled in any one crossing movement, and therefore such facilities should be provided wherever possible.
- 8.4.3.4 With regard to the actual crossing period time allocated wherever possible more than the minimum period calculated should be allotted as this will also aid pedestrians, especially people with disabilities. In this respect the flashing green period required for people with disabilities should be determined on the basis of a walking speed of 0.9 m/sec rather than the 1.2 m/sec normally recommended in Volume 4, and the minimum period for the steady green should not be less than 6 seconds.

- 8.4.3.5 Audible signals will be installed as part of any new light signal controlled crossing scheme. Electronic audible signals which will adjust their sound level output in accordance with the ambient noise condition are being installed progressively to replace the existing mechanical ones.
- 8.4.3.6 Zebra crossings are of course preferable to cautionary crossings. Even though it is a legal requirement for motorists to give way to pedestrians on the crossing, the pedestrians are still not entirely certain whether a vehicle is going to stop or not. Additionally, people with severe loss of eyesight have no real means of differentiating a zebra crossing from a cautionary crossing. On the crossing itself this differentiation can be assisted by ensuring that thermoplastic marking material or similar is used in preference to paint to mark the stripes, as this provides a change in texture, as well as a less slippery and hence safer crossing place.
- 8.4.3.7 Care should be taken that any street furniture does not obstruct any part of the crossing. Where railings are installed on the crossing approaches they should normally be taken to the edges of the crossing, so that they are in line with any studs marking the limits of the crossing width. The location of the railings in this manner will provide positive guidance to people with visual impairment as to where the crossing is and avoid them crossing outside the limits of the crossing.
- 8.4.3.8 At signalised crossings, care should be taken to ensure that the signal post is suitably sited in relation to the crossing, unnecessary obstructions do not occur between the post and the crossing, and the length of railing between the post and the crossing should not be longer than 600mm. This is illustrated in Diagram 8.4.3.1 (The railing as shown on the Diagram is an ordinary Type II railing. For other types of pedestrian railing, the supported post may be located at the end of the railing next to the edge of the crossing).
- 8.4.3.9 Whilst the advantages of grade separated crossings, whether subways or footbridges, in separating pedestrians from vehicular traffic are recognised, they are far from ideal as far as people with disabilities are concerned. The lengthy detours generally involved and the difficulties of ascending and descending such facilities even using the ramps are of considerable problems for people with disabilities.
- 8.4.3.10 If it is necessary to provide a grade separated crossing in any particular scheme, the designer should make every endeavour to use the most advantageous standards rather than just the minimum permitted. Care should also be taken that ancillary details such as handrails are most effectively located. Handrails on steps for example should be positioned approximately 850mm above the steps as any higher than this can be very inconvenient.
- 8.4.3.11 Access for people with disabilities should be provided on all footbridges, elevated walkways and subways either by the provision of ramps or lifts. It is perhaps relevant to mention that escalators, unless specifically designed for people with disabilities are not a suitable alternative to ramps or lifts. Similarly stepped ramps should not be considered as an alternative to ramps or lifts. A circular ramp is not a preferred design solution since it may adversely affect steering, particularly on manually propelled wheelchair. When considering retrofitting barrier-free access to existing grade-separated crossings or in designing new projects of footbridges, elevated walkways and subways, the project office should uphold the principles of the Transport Bureau Technical Circular No. 2/00, unless the local site conditions will impose unjustifiable hardship to the project office. In such exceptional circumstances where access for people with disabilities cannot be retrofitted at the existing grade-separated crossing, the project office should look for alternative access for people with disabilities such as at-grade crossings in consultation with relevant parties. For the definition of unjustifiable hardship, reference should be made to Section 4 of Cap.487 Disability Discrimination Ordinance.
- 8.4.3.12 For considerations in determining whether a ramp or a lift should be provided, the project proponent should refer to Section 3.7.7.11 of Volume 2, Chapter 3 of the Transport Planning and Design Manual.

- 8.4.3.13 It is stipulated in Regulation 72 of the Building (Planning) Regulations that accessible lifts shall be provided in all newly constructed buildings. If the accessible lifts in these buildings are open to the general public for 24 hours a day and reach the level linking to elevated walkways, relevant access and facilities in the buildings shall form part of an accessible route. In planning new building development projects, consideration should be given to developing linkage between new pedestrian facilities and existing routes in a barrier-free manner.
- 8.4.3.14 Tactile warning strips should be provided at ramp and staircase for people with visual impairment with two rows at the landings and one row only at intermediate landings as illustrated in Diagram 8.4.3.2.
- 8.4.3.15 The nosings of steps of staircases should be in high visual contrast with adjacent surface to enable pedestrians including those with low vision to differentiate the steps. The flight of steps should be kept free of long and straight horizontal pattern except for nosings. Steps of alternate colour should be avoided. This also includes all landings beyond end steps. It is advisable that the concerned organisations for the people with disabilities should be consulted on the visual contrast by providing mock-up panels for the proposed nosing/adjoining surface combination for inspection or by other similar means. Having established visual contrasting combinations which are acceptable to this group, any one of the combinations could be used in a specific project. All steps should be uniform. Circular stair and sloped landing should be avoided.
- 8.4.3.16 Tactile warning strips should be provided at both ends of the escalator for people with visual impairment. A typical arrangement is illustrated in Diagram 8.4.3.3.

DIAGRAM 8.4.3.1 : PEDESTRIAN LIGHT SIGNAL ARRANGEMENT

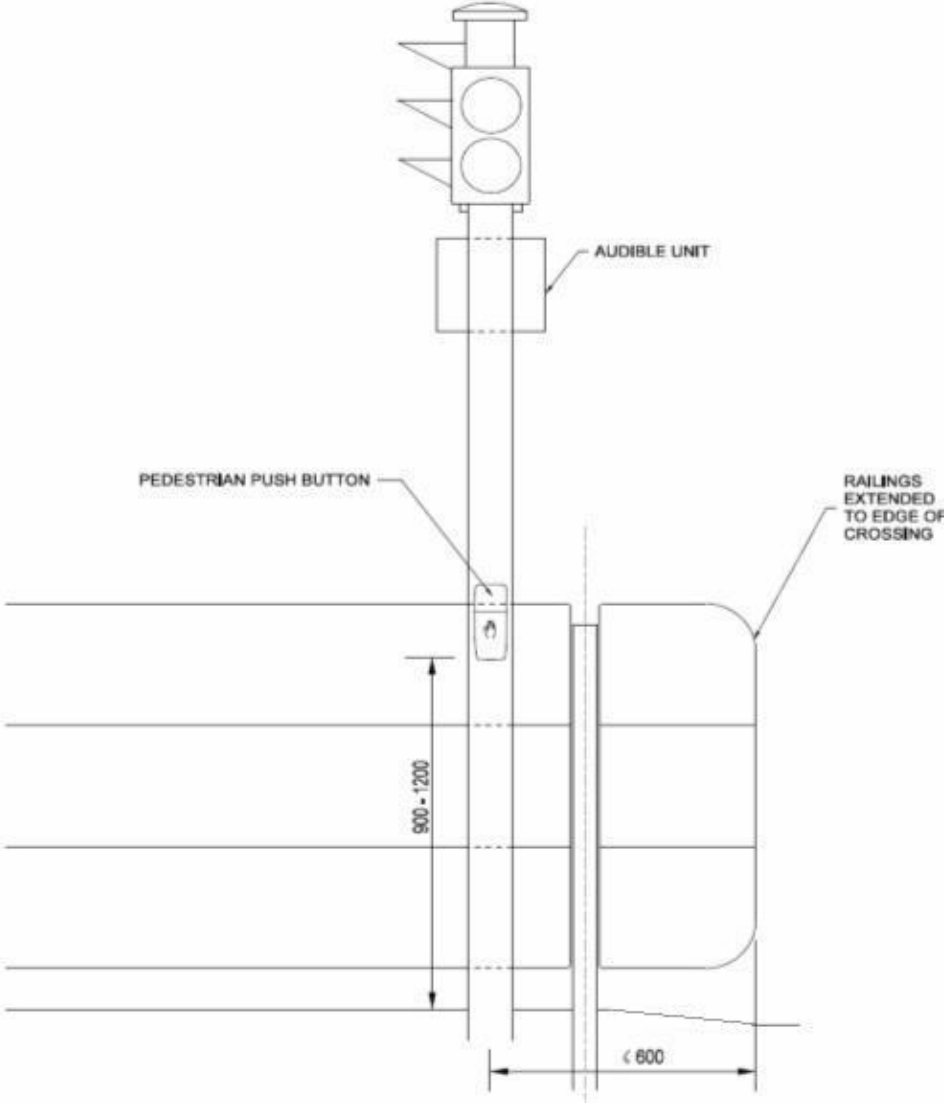

ALL DIMENSIONS ARE IN MILLIMETRES

DIAGRAM 8.4.3.2 : TACTILE WARNING STRIPS FOR RAMP & STAIRCASE

SIDE VIEW OF INSTALLATION AT A RAMP

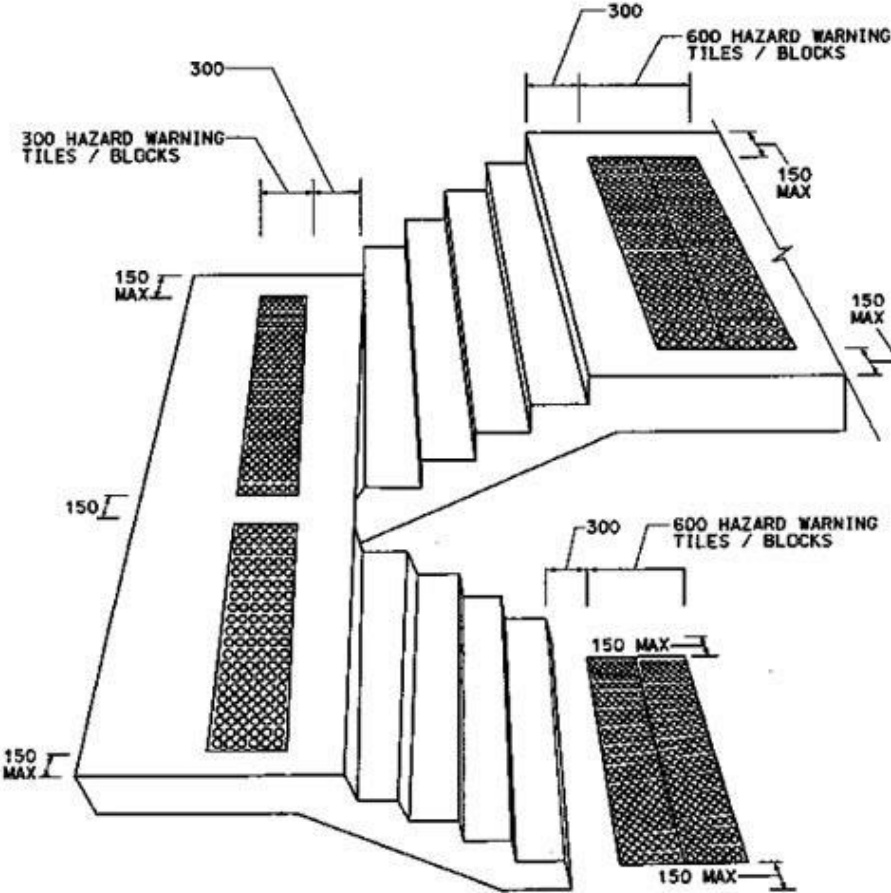
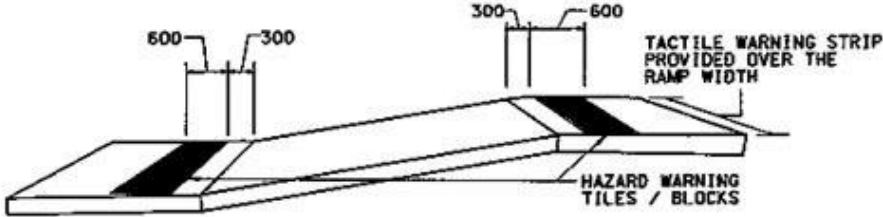

ALL DIMENSIONS ARE IN MILLIMETRES

DIAGRAM 8.4.3.3 : TACTILE WARNING STRIPS FOR ESCALATOR

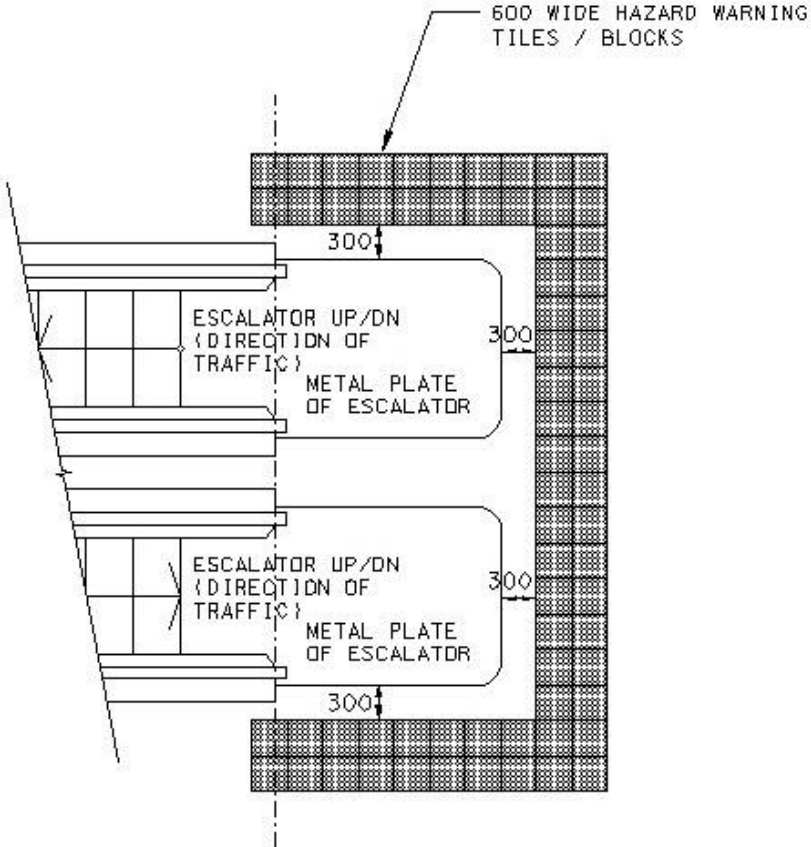

ALL DIMENSIONS ARE IN MILLIMETRES

8.5 Parking Facilities

8.5.1 General

8.5.1.1 In order that maximum benefit is gained by improved mobility it is important that suitable parking facilities are available for drivers with disabilities.

8.5.1.2 Such parking facilities, both on- and off-street, do require additional considerations to that given in respect of general parking requirements, and it is the objective of this section to provide the designer with suitable guidelines with regard to these.

8.5.2 Off-street Parking Facilities

8.5.2.1 Public parking facilities in buildings shall provide car parking spaces for drivers with disabilities with reference to Regulation 72 of the Building (Planning) Regulations.

8.5.2.2 The recommended provision of car parking spaces for drivers with disabilities in off-street parking facilities is as follows :

<u>Total No. of Car Parking Space in Lot</u>	<u>Required No. of Car Parking Spaces for Drivers with Disabilities</u>
1-50	1
51-150	2
151-250	3
251-350	4
351-450	5
Above 450	6

8.5.2.3 Designer should observe the following principles in determining the location of car parking spaces for drivers with disabilities :

- (i) Such car parking spaces are located where the longitudinal gradient is level or near level.
- (ii) Such car parking spaces should be located in close proximity to exit/entrance or accessible lifts meeting the requirements of the Building (Planning) Regulations and other relevant legislations.
- (iii) Any steps between the parking floor and the lift lobby, or from the lift lobby to the street, must be suitably ramped. In respect of steps on the parking floor, it is preferable that the ramps are constructed parallel to the entrance to the lift lobby to avoid wheelchairs running across the paths of circulating vehicles. This is illustrated in Diagram 8.5.2.1. The gradient for these ramps should not be steeper than 1 in 12, and preferably 1 in 20.
- (iv) Such car parking spaces should be provided in covered area.

8.5.2.4 It is recommended that off-street car parking spaces for drivers with disabilities should have a minimum width of 3.5m as shown in Diagram 8.5.2.2 to provide sufficient space for a wheelchair user to get on/off the vehicle.

8.5.2.5 Where there is more than one space to be provided the effect of the additional width can be lessened by having a shared common loading/unloading area with a width of 1.2m between adjacent spaces, as shown in Diagram 8.5.2.3. The common loading/unloading area must however be marked with yellow hatched markings to ensure that this area does remain free of any parked vehicles.

8.5.2.6 Car parking spaces provided for drivers with disabilities must be clearly marked on the floor of each space with the international symbol of accessibility and the space number, as shown in Diagrams 8.5.2.2 and 8.5.2.3 to facilitate identification of such spaces.

DIAGRAM 8.5.2.1 : RAMPED ACCESS TO LIFT LOBBY

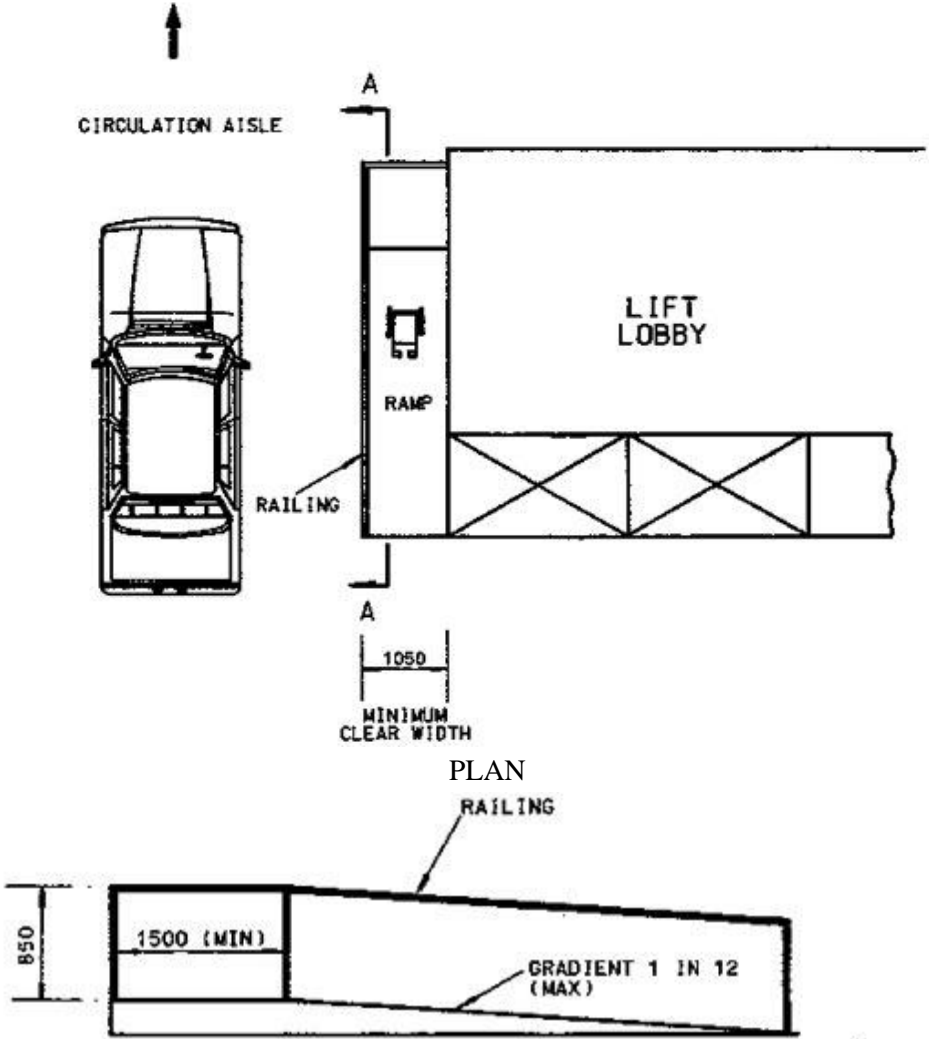

SECTION A - A
ALL DIMENSIONS ARE IN MILLIMETRES

DIAGRAM 8.5.2.2 : PARKING BAY DIMENSIONS AND IDENTIFICATION

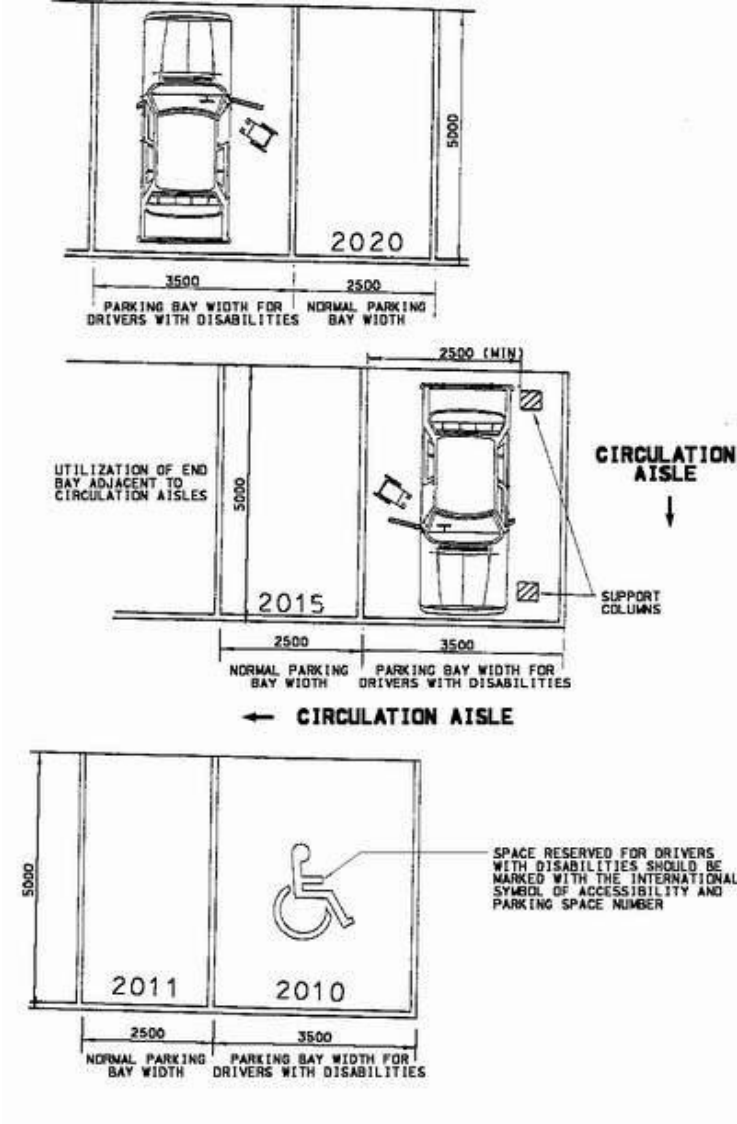

ALL DIMENSIONS ARE IN MILLIMETRES

DIAGRAM 8.5.2.3 : SIDE BY SIDE PARKING FOR LIMITED SPACE

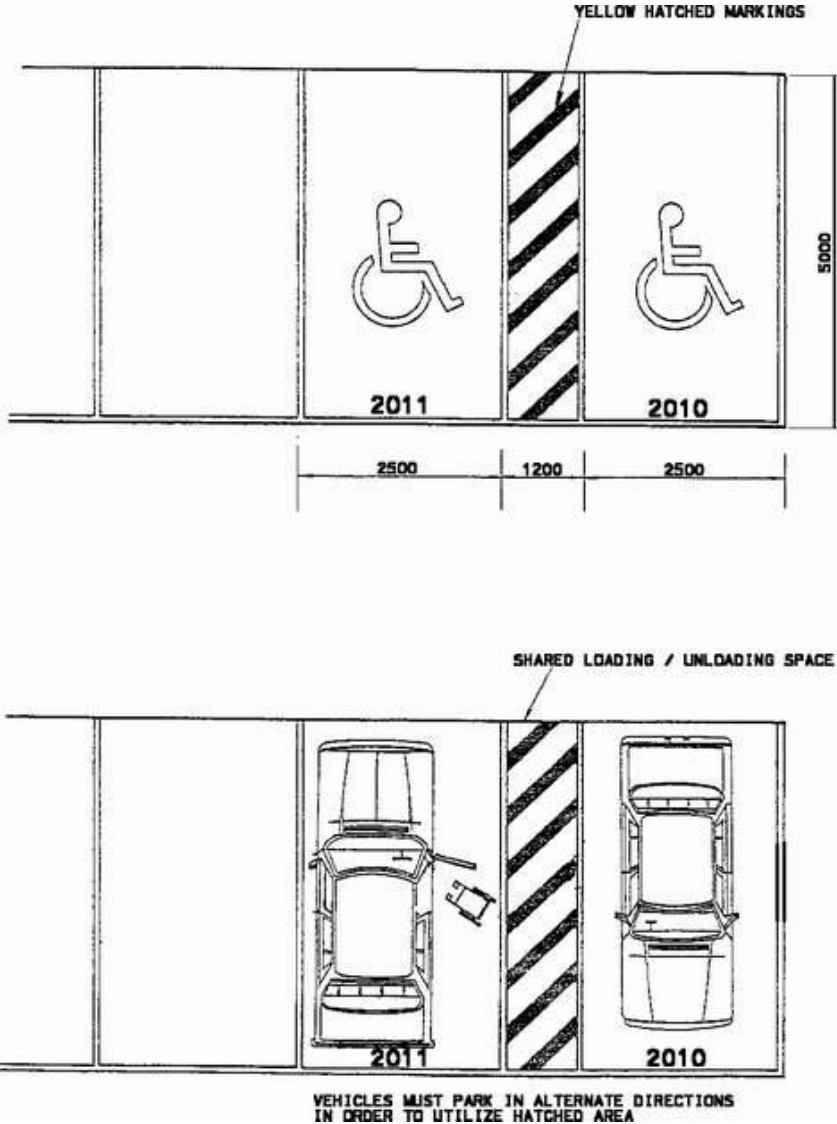

ALL DIMENSIONS ARE IN MILLIMETRES

8.5.2.7 Proper and adequate signings are provided at the entrances to indicate the exact locations of such car parking spaces as shown in Diagram 8.5.2.4.

DIAGRAM 8.5.2.4 : PARKING SPACE ALLOCATION SIGN
SIGN TO BE DISPLAYED IN PROMINENT POSITION AT ENTRANCE

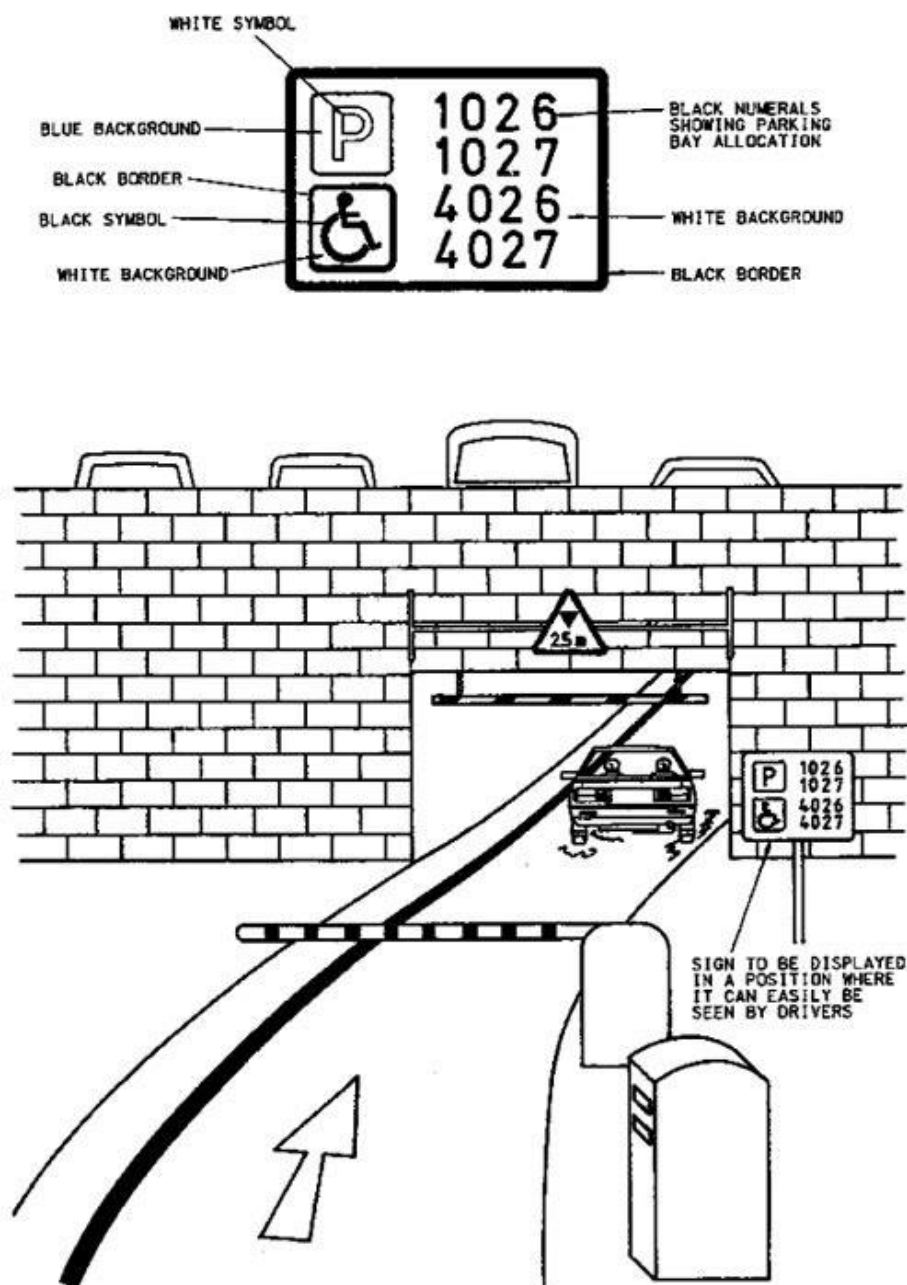

8.5.3 On-street Parking

8.5.3.1 The dimensions of on-street parking space for drivers with disabilities should be in accordance with Diagram 8.5.3.1.

8.5.3.2 To ensure that wheelchairs can be adequately loaded/unloaded, care should be taken that :

- (i) the parking space should be long enough for the vehicle to be manoeuvred and parked with its nearside wheels against the kerb;
- (ii) the footway should be wide enough for the passenger and rear doors to be fully opened and remain open without obstructing or causing a danger to passing pedestrians unnecessarily; and
- (iii) the kerb height does not create difficulties in respect of boarding or alighting from the wheelchair. With regard to this, it will be helpful if dropped kerb can be provided along the length of the reserved parking space.

8.5.3.3 Where on-street parking is required for Rehabus which is licenced as light bus, allowance must be made for the platform at the rear to be able to operate, and for wheelchair occupants to board and alight from this platform. In this respect it is recommended that a minimum 7 m length be provided together with an additional 1.2m hatched area to allow for access to and from the platform, as illustrated in Diagram 8.5.3.2. Where on-street parking is required rehabus which is licenced as bus, allowance must be made for the platform at the side for boarding and alighting of passengers. A minimum 11 m length and 6 m width should be provided.

8.5.3.4 Traffic signs 347 and 348 as shown in Diagram 8.5.3.3 should be erected at both ends of the car parking space(s) reserved for the vehicles with disabled person's parking permit or parking certificate for drivers who carry people with mobility disabilities. Parking space for drivers with disabilities should be painted in blue, and the international symbol of accessibility should be painted as illustrated in Diagram 8.5.3.4 to help all drivers identify the car parking space as one reserved for the vehicles with disabled person's parking permit. The blue dressing may however be unnecessary for temporary relocation of parking space for drivers with disabilities from maintenance point of view.

Diagram 8.5.3.4 indicates footways are typically adjacent to on-street parking for access of wheelchairs. If no footway adjoins the parking space, wherever possible, additional 1.2m hatched area should be provided on the side and at the back of the parking spaces as appropriate to facilitate wheelchair access from both rear and side of the vehicles. The additional area is useful for access of Drive-from-Wheelchair vehicles.

DIAGRAM 8.5.3.1 : ON-STREET SPACE DIMENSIONS AND OTHER FEATURES

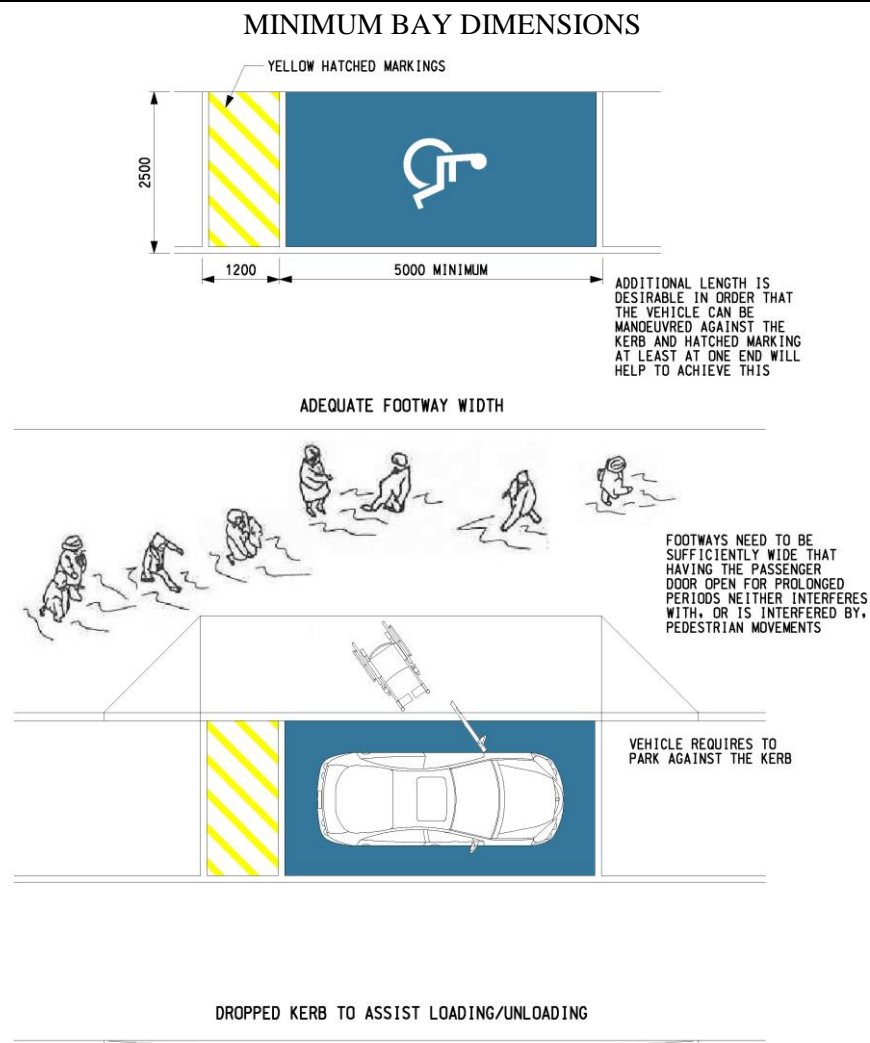

ALL DIMENSIONS ARE IN MILLIMETRES

DIAGRAM 8.5.3.2 : PARKING SPACE DIMENSIONS FOR REHABUS

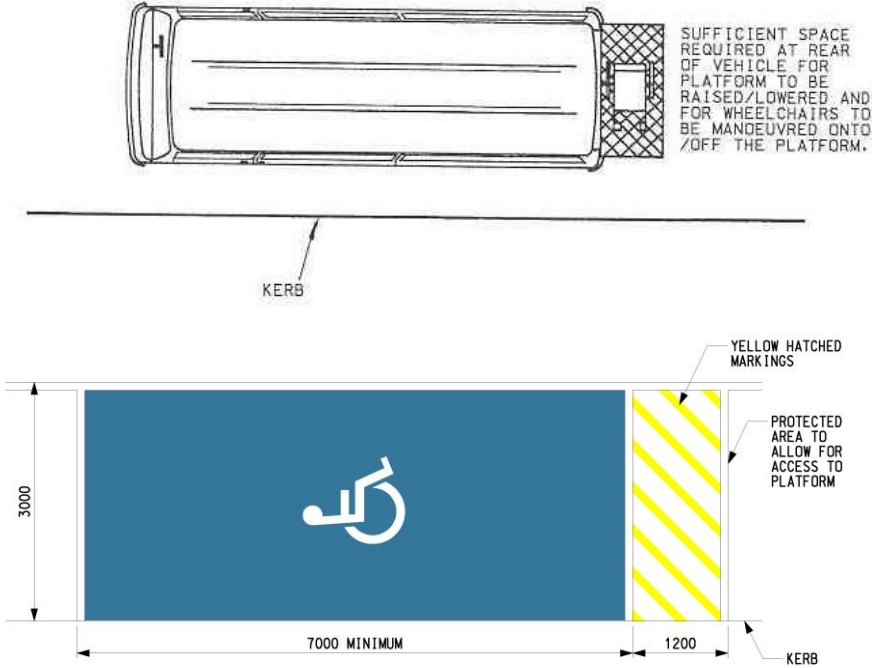

ALL DIMENSIONS ARE IN MILLIMETRES

DIAGRAM 8.5.3.3 : SIGNING ARRANGMENT FOR ON-STREET PARKING SPACE FOR DRIVERS WITH DISABILITIES / REHABUSES



TS 348

TS 347

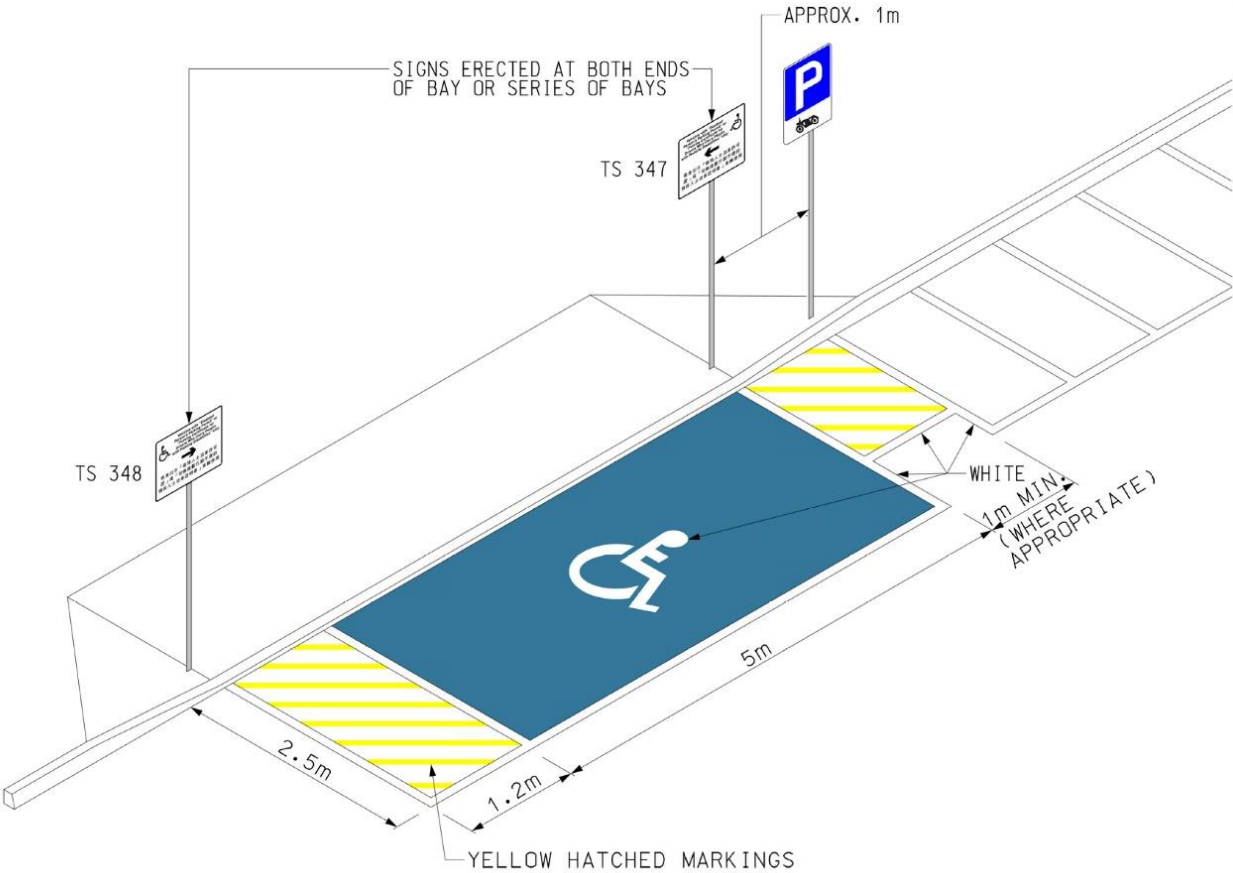
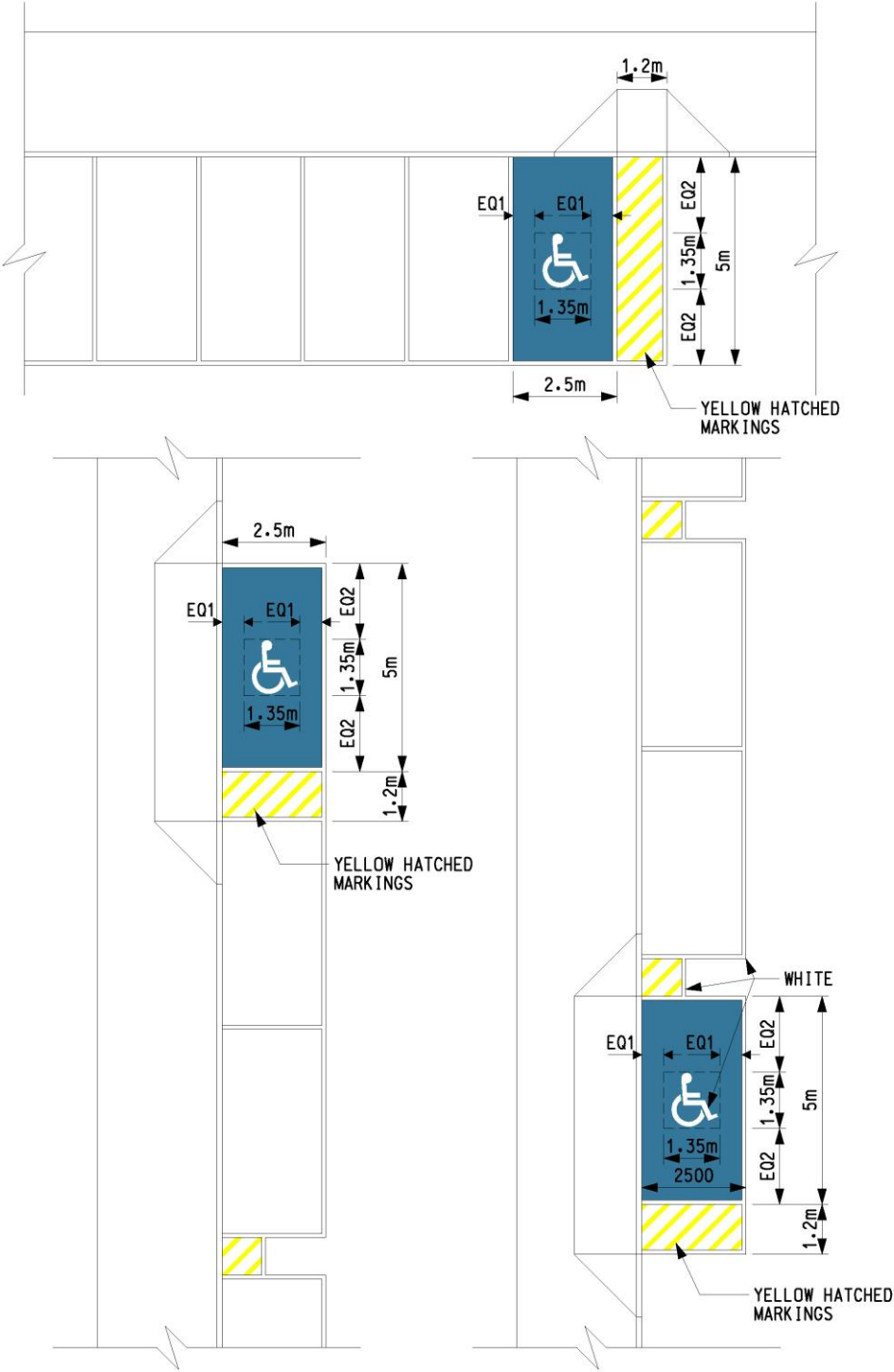

DIAGRAM 8.5.3.4 : MARKING FOR ON-STREET PARKING SPACES RESERVED FOR DRIVERS WITH DISABILITIES / REHABUSES



8.6 Road Works for People with Disabilities

8.6.1 General

- 8.6.1.1 People with disabilities are not alone in being adversely affected by road works as all members of the community whether as pedestrians, motorists or passengers in public or private transport suffer some inconvenience.
- 8.6.1.2 However whilst more able bodied persons can generally overcome the difficulties presented by loose planks on temporary footways, or building material piled across the footway, or excavations not properly fenced, to people with disabilities these may constitute extreme dangers and often mean that the continuation of their journey, at least by that route, is prevented.
- 8.6.1.3 The necessity that road works must be carried out is fully recognised and accepted, as is the fact that some inconvenience is bound to result. However what is not considered acceptable is that road works would place certain sections of the community, and in particular people with disabilities, at extreme risk or would cause them to make a longer detour because of insufficient consideration and bad workmanship.
- 8.6.1.4 The Code of Practice for the Lighting, Signing and Guarding of Road Works provides practical advice on these matters and must be followed, though it cannot of course provide for every eventuality.
- 8.6.1.5 The objective of this section is to highlight those aspects which, if advice given in the Code is not followed, can cause particular problems to people with disabilities.

8.6.2 Guidance at Road Works

- 8.6.2.1 All excavations whether on the carriageway or footway must be adequately protected i.e. fenced. However in respect of footways, or on those parts of the carriageway where pedestrians may need to walk, particular attention should be given to the type of fencing that is used.
- 8.6.2.2 Diagram 8.6.2.1 illustrates two different types of pedestrian fencing for road works, though other types may also be used. However whatever type is used it is important that the railings should incorporate the following features :
- (i) the height of the top of the rail should be at least 1000mm above the adjacent surface;
 - (ii) the railing should incorporate a tapping rail to assist people with visual impairment, and this should not be higher than 350mm above the adjacent surface;
 - (iii) the fence should be strong enough to offer resistance should people with visual impairment walk into it; and
 - (iv) gaps should not occur between adjoining fence lengths.

- 8.6.2.3 As stated in the Code of Practice for the Lighting, Signing and Guarding of Road Works published by Highways Department, and as further illustrated in Diagram 8.6.2.2, the footway width past any obstruction should not be less than 1500mm. However as shown in Diagram 8.2.3.1 the effective operating width of the wheelchair users is up to 1000mm. With only a 1500mm footway space available, the wheelchair and other users will likely cause inconvenience to each other. Therefore wherever possible the minimum width should desirably be not less than 1800mm. It is also essential that the width is the effective width available and is measured from any concrete blocks or similar used to support the railings and not from the railing itself.
- 8.6.2.4 Similar to railings, any scaffolding or hoarding should also, as shown in Diagram 8.6.2.2, allow a minimum effective footway width of 1500mm and preferably not less than 1800mm. It is also helpful particularly for people with low vision, that in addition to the normal lighting and signing required hoarding are painted a bright colour to aid visibility. If this cannot be done in respect of bamboo scaffolding, each upright support should have a white band 150mm in depth, and at a height of 1000mm above the footway, as shown in Diagram 8.6.2.2.
- 8.6.2.5 Footways are often, quite wrongly, used for the storage of materials and spoil. Where this cannot be avoided, the material must be properly fenced to avoid any danger being caused to people with visual impairment. If it is loose material it must be prevented from encroaching onto the remaining footway, by the use of a "kick board", which will also act as a tapping board for people with visual impairment. The board should be at least 200mm high as shown in Diagram 8.6.2.3 though it may need to be much higher in certain case to ensure that the material is properly contained and does not spill onto the footway.
- 8.6.2.6 When excavation is not in progress, the excavated areas in the footway or carriageway should be covered temporarily with properly constructed and supported boards to provide a temporary path for pedestrians as shown in Diagram 8.6.2.4.

DIAGRAM 8.6.2.1 : FENCING FOR ROAD WORKS ON FOOTWAY

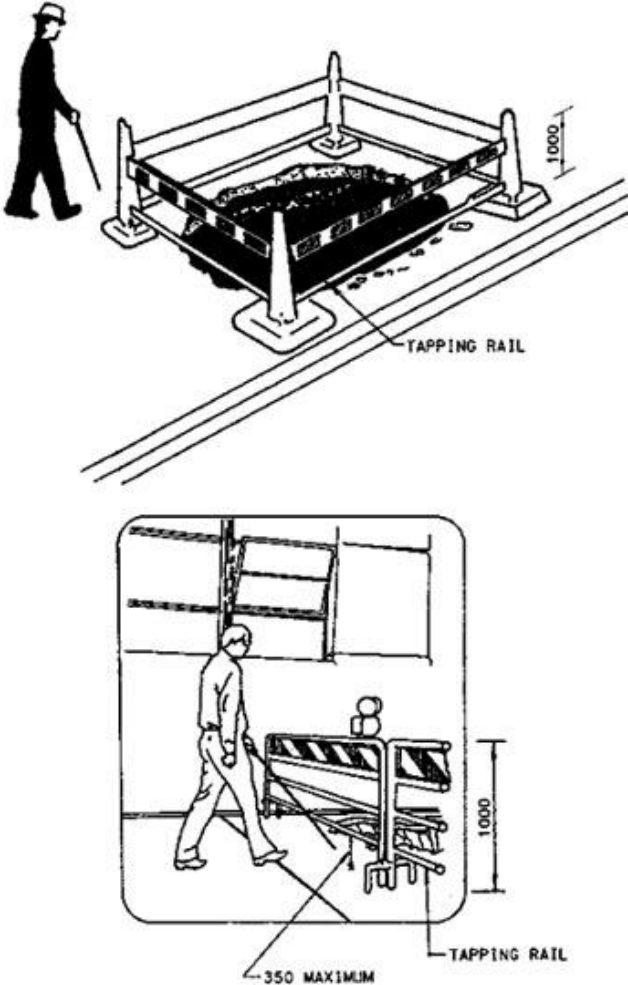

ALL DIMENSIONS ARE IN MILLIMETRES

DIAGRAM 8.6.2.2 : MINIMUM DIMENSIONS AT OBSTRUCTIONS

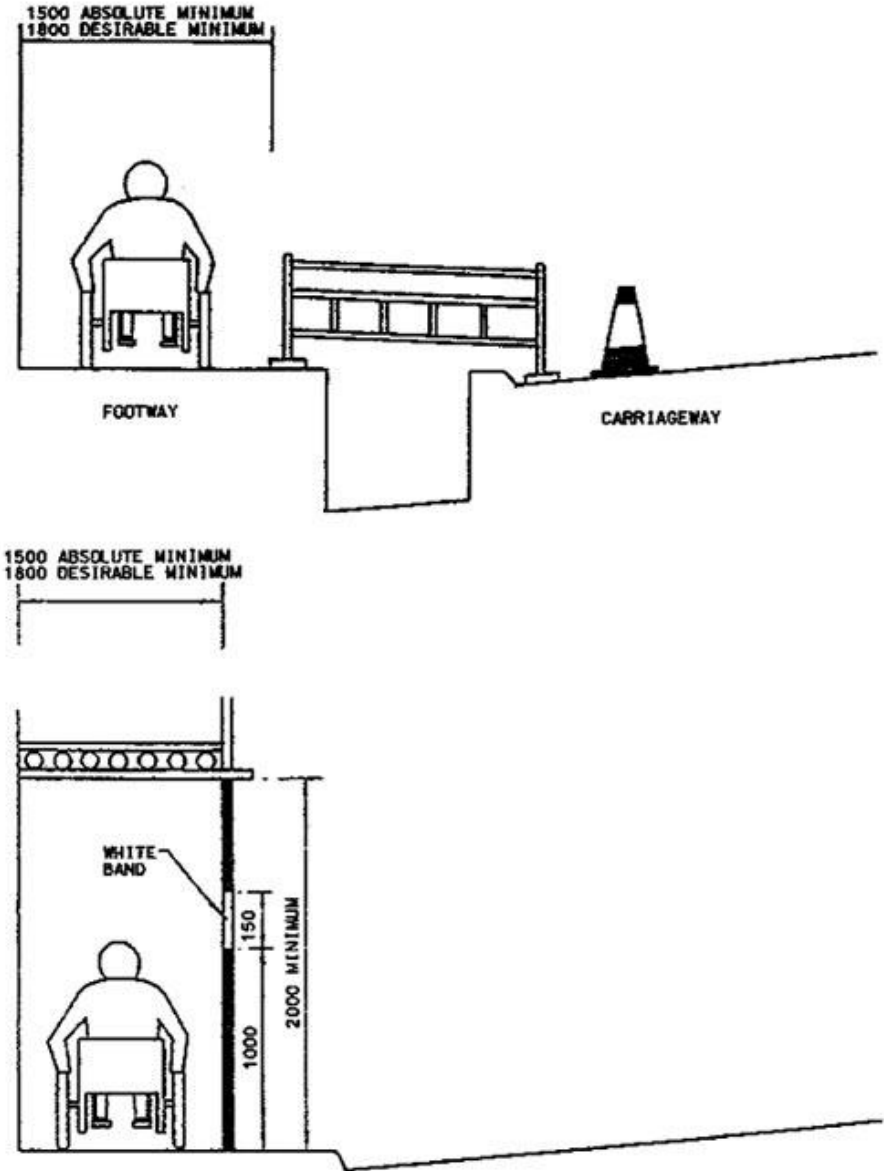

ALL DIMENSIONS ARE IN MILLIMETRES

DIAGRAM 8.6.2.3 : STORAGE OF MATERIAL ON FOOTWAY
STORAGE OF LOOSE MATERIAL

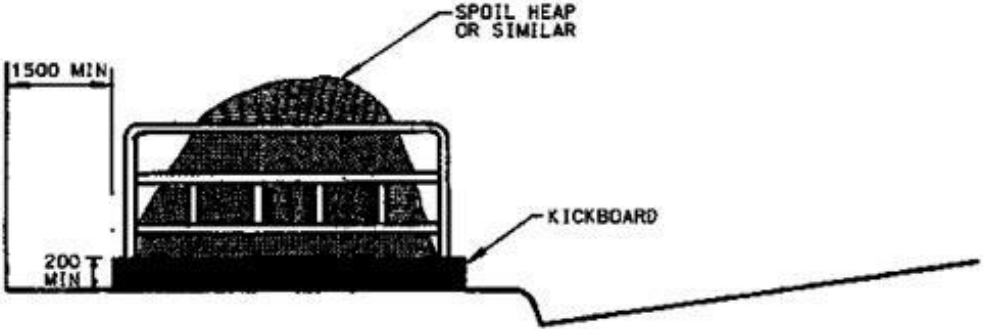

ALL MATERIAL STORED ON FOOTWAY SHOULD BE FENCED

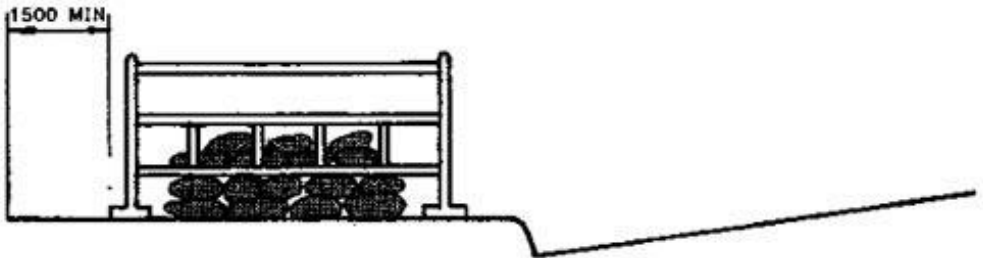

ALL DIMENSIONS ARE IN MILLIMETRES

DIAGRAM 8.6.2.4 : COVERS FOR EXCAVATIONS

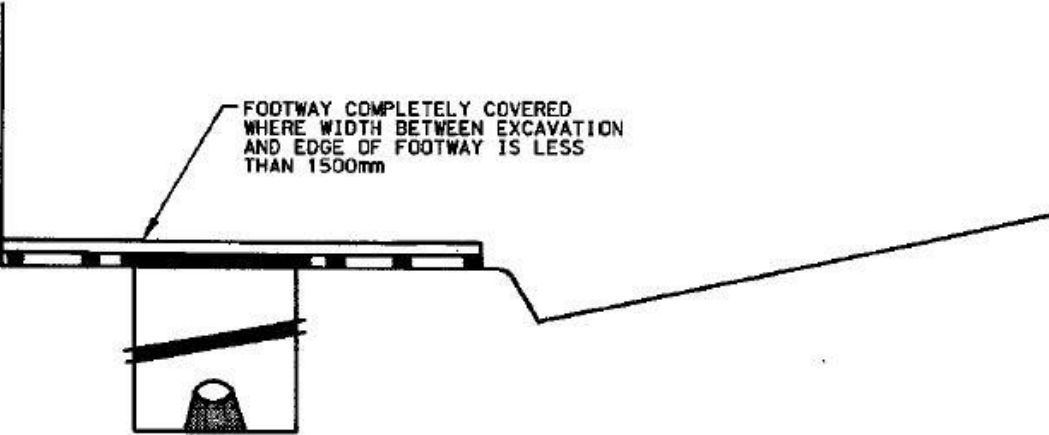
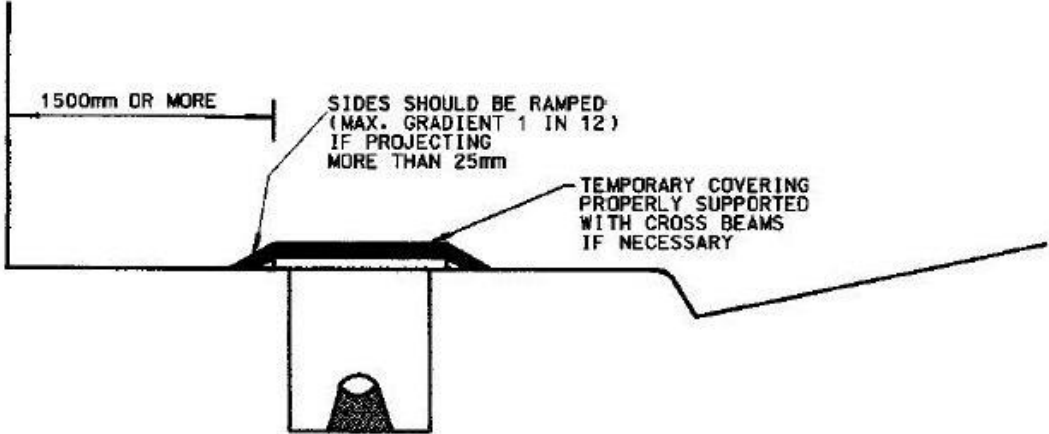

- 8.6.2.7 Where there is at least 1500mm between the edge of the boards covering the excavation and the edges of the footway, only the excavation need to be covered. However if the width is less than this, the covering should extend across the whole of the footway because wheelchairs could be denied access. For all temporary footways, regular maintenance of the footway must be carried out to ensure that any loose timbers are properly secured, or replaced if necessary.
- 8.6.2.8 Where timber planking is used to form a temporary footway and the sides project above the adjacent footway by more than 25mm, suitable ramping should be provided. In fact it is preferable to avoid any projection even if this is less than 25mm. As with the crowded footway conditions that occur in the territory, even the slightest projection can be a source of danger. Raised temporary footways with appropriate ramping should therefore be provided if possible.
- 8.6.2.9 Temporary signs used to warn of road works should be carefully located and should not cause any inconvenience to pedestrians and particularly to people with disabilities.
- 8.6.2.10 Signs should normally be located near the edge of the carriageway utilising wherever possible any verge or similar that may be present, as shown in Diagram 8.6.2.5.
- 8.6.2.11 If there is no verge, signs may be placed on footway. However, a minimum width of 1500mm should be maintained and greater widths for busy urban areas. If the footway is reduced to less than 1500mm wide, other measures will need to be taken. Any signs relating to road works on the carriageway should be placed on the carriageway with suitable cones to guide traffic around the signs. However, if the sign relating to works on the footway causes obstruction to pedestrians, pedestrians will need to be diverted to walk onto the carriageway.
- 8.6.2.12 Where it is considered desirable to utilise part of the carriageway as a footway agreement of the police must be obtained first. Additionally as well as the normal signing requirements, ramps should be provided from the kerb to the carriageway as shown in Diagram 8.6.2.6, in order to remove any obstacle caused by the kerb to people with disabilities.
- 8.6.2.13 Utilisation of part of the carriageway as footway is relevant where footways are being resurfaced, as it is unreasonable to expect pedestrians to have to squeeze around the area being resurfaced, or walk unprotected along the carriageway.
- 8.6.2.14 Following completion of any works, all signs, fences and surplus material must be removed immediately and footways should be swept to ensure loose debris is removed. Temporary reinstatement of footway surfaces should be carried out to provide a reasonably smooth walking surface. Final reinstatement with backfill material should be properly compacted to ensure that the ultimate surface will remain level with the adjacent footway.

DIAGRAM 8.6.2.5 : SIGNING FOR ROAD WORKS ON CARRIAGEWAY

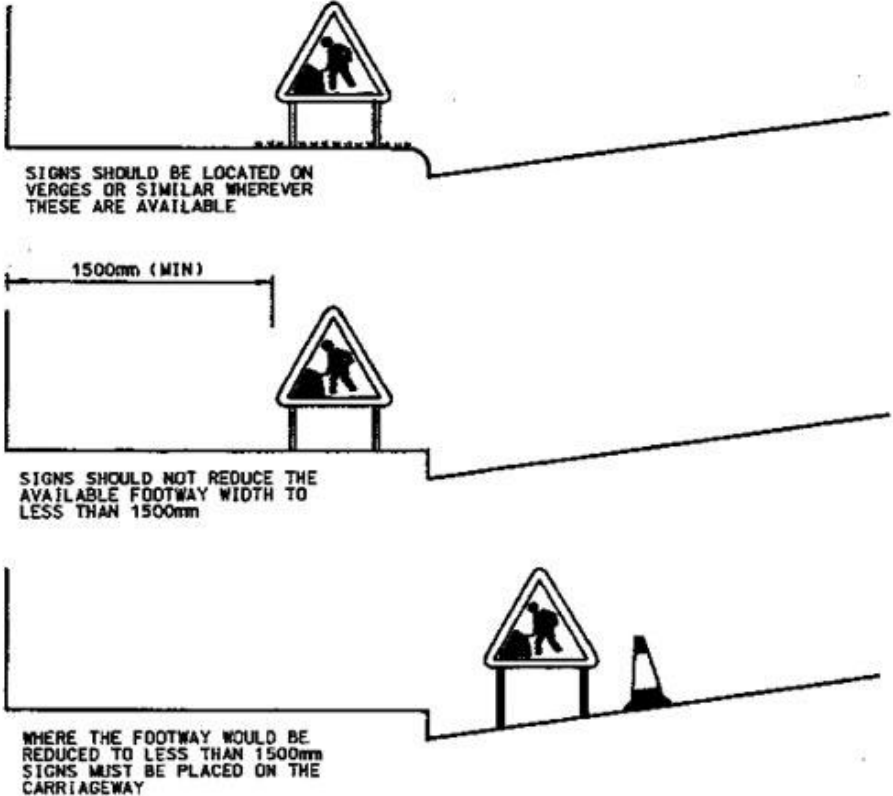
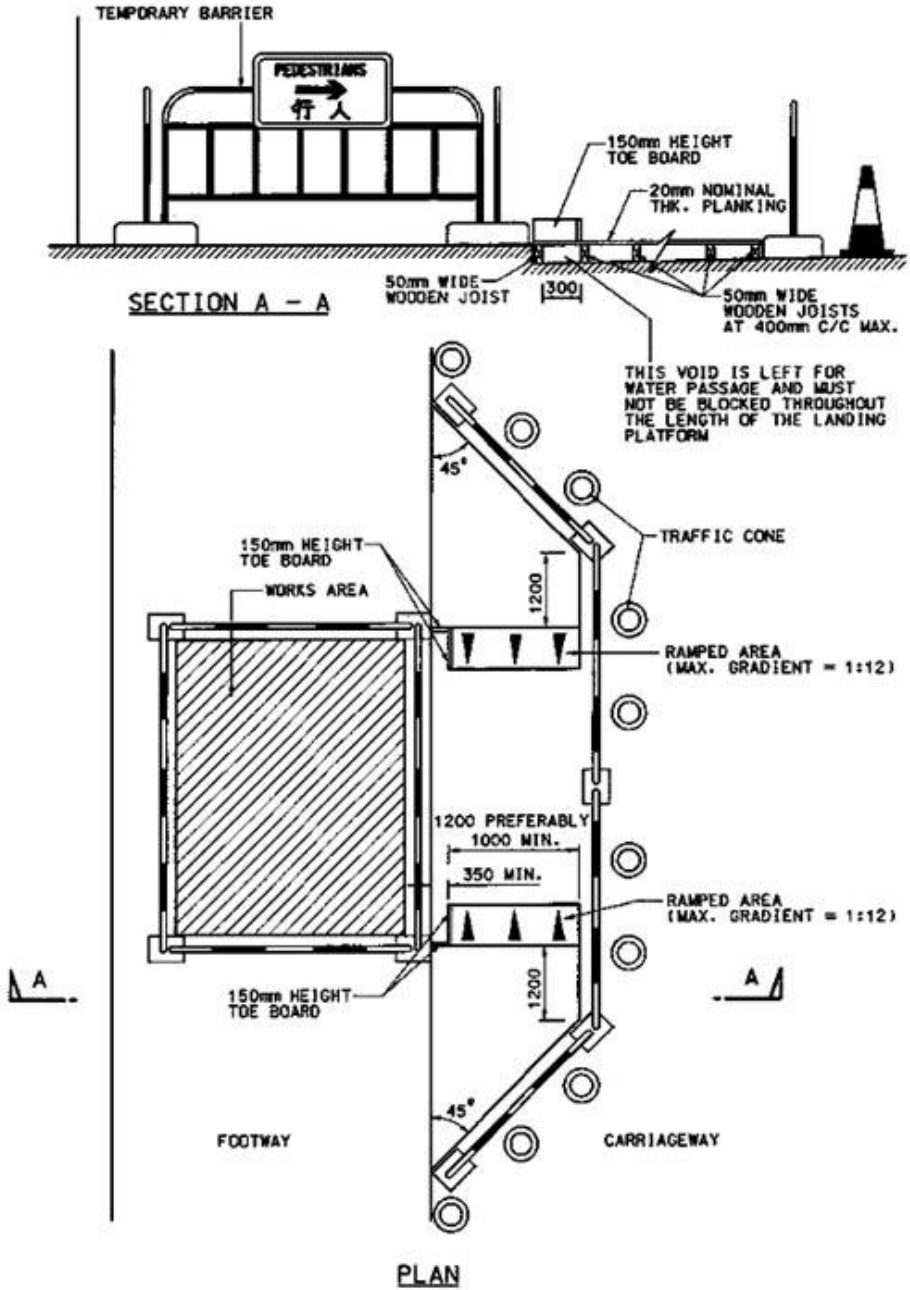

DIAGRAM 8.6.2.6 : TYPICAL ARRANGEMENT OF TEMPORARY FOOTWAY DIVERSION



ALL DIMENSIONS ARE IN MILLIMETRES

8.7 Signing

8.7.1 General

- 8.7.1.1 Traffic signs can be used in a variety of way to provide useful information for people with disabilities, or to advise other road users of the presence of people with disabilities and the necessity to take extra care.
- 8.7.1.2 Although general practice is to avoid the over use of traffic signs, as the signs together with any support posts can themselves cause obstruction, in respect of people with disabilities a more liberal attitude should wherever possible be adopted, particularly in respect of identifying routes suitable for their use.
- 8.7.1.3 The objective of this section is to outline the use of the international symbol of accessibility on various signs so as to indicate the accessible routes and ensure road safety for people with disabilities.
- 8.7.1.4 For actual design details of signs generally as well as advice on sign size and location Volume 3 should be referred to.

8.7.2 Sign Types

- 8.7.2.1 In the vicinity of establishments such as schools, hospitals or workshops where relatively large numbers of people with disabilities are expected it is appropriate to consider the erection of traffic sign 462, as in Diagram 8.7.2.1, as appropriate to warn motorists that there may be people with disabilities adjacent to the carriageway or crossing the road ahead. See also Section 2.3.3 of Chapter 2, Volume3.
- 8.7.2.2 Public toilets which are accessible to people with disabilities should be identified by direction sign, traffic sign 653, or similar, as shown in Diagram 8.7.2.1.
- 8.7.2.3 Where accessible routes can be made available for people with disabilities from transport interchanges, or similar, to places of special interest in the immediate vicinity, but these do not follow the normal pedestrian path, direction signs as for example traffic sign 655, should be erected indicating the path to be followed.
- 8.7.2.4 In locations where pedestrian route direction signs are erected, and if there are no steps along the route impeding any wheelchair users, then the international symbol of accessibility should also be incorporated in the sign as shown in Diagram 8.7.2.2.
- 8.7.2.5 As intermediary signs along a route, or to indicate highway facilities that can be utilised by people with disabilities, consideration should be given to erecting the signs shown in Diagram 8.7.2.2.
- 8.7.2.6 These intermediary signs should be positioned at a lower mounting height than normal to make it more visible to people with disabilities and the base of the sign should not be higher than 1.5 m above the adjacent footway level. Because of this lower mounting height, care will need to be taken to enhance that the sign is not causing danger to pedestrians. Alternatively consideration could be given to attach the sign to convenient street furniture, such as signposts, lighting columns, signal control boxes or similar.

8.7.2.7 Whether it should have direction arrows or not on the intermediary signs will depend on the particular circumstances. For identification of the actual facility the intermediary sign without arrows will be appropriate. When indicating the direction of such a facility then the intermediary sign with an arrow pointing towards this should be erected. In the case of a complete pedestrian route which can be used in both directions by people with disabilities, then the intermediary sign with arrows pointing in both directions will be appropriate.

8.7.2.8 For information concerning parking signs in respect of people with disabilities, Section 8.5 should be referred to.

DIAGRAM 8.7.2.1 : SIGNING FOR PEOPLE WITH DISABILITIES

TRAFFIC SIGN 462 PEOPLE WITH DISABILITIES AHEAD

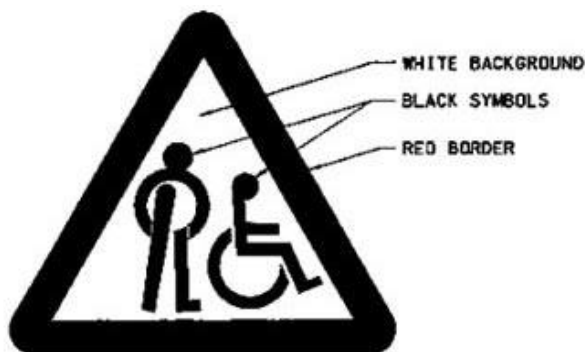

TRAFFIC SIGN 653 TOILETS WITH FACILITIES FOR PEOPLE WITH DISABILITIES



TRAFFIC SIGN 655 ROUTE WITH FACILITIES FOR PEOPLE WITH DISABILITIES TO COLISEUM



DIAGRAM 8.7.2.2 : ROUTE DIRECTION SIGNS
PEDESTRIAN DIRECTION SIGN INDICATING ACCESSIBLE ROUTE



ALTERNATIVE INTERMEDIARY SIGNS FOR INDICATING ACCESSIBLE ROUTE

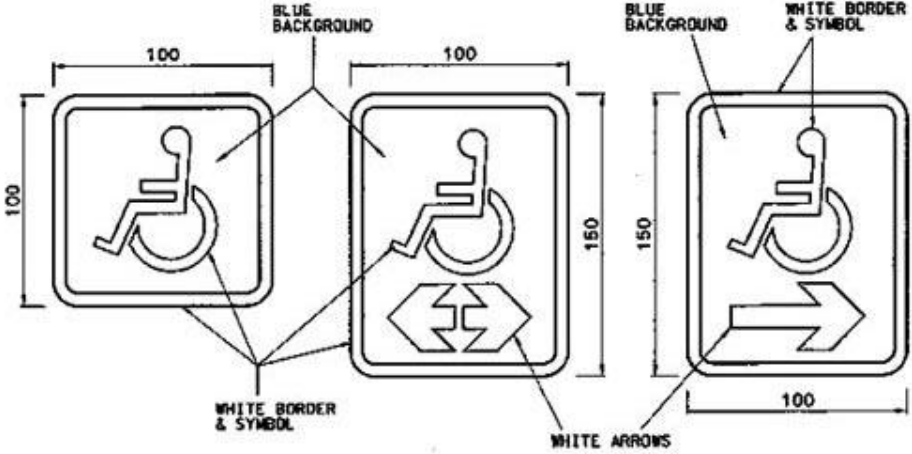

ALL DIMENSIONS ARE IN MILLIMETRES

8.8 Public Transport Services for People with Disabilities

8.8.1 General

- 8.8.1.1 The objectives in respect of public transport services and traffic facilities for people with disabilities should be to provide suitable services to meet their educational, employment, medical, social and recreational needs.
- 8.8.1.2 Policies, programmes and legislation should recognise that people with disabilities have the same rights and needs of able bodied persons to use traffic facilities, and that public transport services for people with disabilities need to form an integral part of the transport system.
- 8.8.1.3 A Working Group on Access to Public Transport for Disabled Persons was set up by the Transport Department in 1993 to provide a useful forum for various groups representing people with disabilities to exchange views on public transport services with the providers and the department.

8.8.2 Public Transport for People with Disabilities

- 8.8.2.1 We should facilitate the use of public transport services by people with disabilities as this will improve their mobility and help them to integrate into the community.
- 8.8.2.2 Not all modes of public transport are suitable for all people with disabilities, such as wheelchair users. Operators of public transport services should be encouraged to provide suitable facilities to facilitate the use of public transport services by people with disabilities
- 8.8.2.3 Where wheelchair users are unable to use public transport services which no wheelchair accessible vehicles are deployed, they may need to rely on the use of Rehabus services.

Rail

- 8.8.2.4 The MTR Corporation Ltd. should make their existing stations and also their future extensions accessible for people with disabilities. The following are examples of facilities which the railway company should provide to facilitate access of people to the stations and their train services.
- (i) At stations
 - (a) ramps, lifts, stair lifts or wheelchair aids;
 - (b) wide exit and entrance gate for wheelchair users;
 - (c) tactile guide paths;
 - (d) audible device at escalators to help passengers locate the escalator to leave and enter platforms;
 - (e) tactile warning strip on platforms;
 - (f) Braille plates on Octopus Add Value Machine;
 - (g) neon flashing lights at curve platform (MTR East Rail Stations only);
 - (h) Braille station layout maps (MTR East Rail Stations only);
 - (i) public announcement system;

- (i) (j) information panel; and
- (k) portable gang plank to bridge the wide gap between train and platform (MTR East Rail Stations only).
- (ii) Inside train compartment
 - (a) wheelchair parking spaces;
 - (b) public announcement;
 - (c) colour contrast grab poles and rails; and
 - (d) Buzzer sound of opening/closing doors.

8.8.2.5 Because of the narrow width of the tram stop platform and inaccessible compartment, tramway service is inaccessible to wheelchair users. Persons with visual impairment and people with minor walking difficulties may board the tram via the front door with assistance from the tram driver.

8.8.2.6 Peak Tramway is a cable-hauled funicular railway service which is accessible to most people with disabilities except wheelchair users. Wheelchair users may seek assistance from the station staff. Special facilities such as ramps, special access gates and call bells are available at platforms.

Franchised bus

8.8.2.7 To cater for the need of people with disabilities, bus operators should provide the following facilities on their new vehicles :

- (i) Low floor design (step-free layout between the entrance and exit doorways) and slip-resistant floors;
- (ii) Built-in boarding alighting fixed ramp;
- (iii) Wheelchair parking space;
- (iv) A wheelchair symbol should be displayed on the front of the bus so that wheelchair users are able to recognize accessible buses; and
- (v) A handrail or series of handholds shall be fitted along one or both side of a gangway and on both sides of an entrance or exit at a height of 800-900 mm above the floor. Handrails shall have a reasonable diameter (about 30-35 mm) and clearance (45 mm or more) so as to be easily and firmly gripped by a passenger, and shall have a slip-resistant colour-contrasting surface.
- (vi) Seats should be reserved for the people with disabilities. The seat should be located at a convenient location inside the bus compartment, and should be designed for ease of access.
- (vii) To assist the people with disabilities in stopping the bus, low level bell pushes should be installed near the seats reserved for them, such that these can be rung without the person having to rise.

- (viii) The destination boards should be made as large as the destination screen allows and in high contrast colour so that at least the main destination and the route number can be easily recognised from a reasonable distance. It is also of value to have a route number on the side of the bus near the entrance as this provides a further opportunity particular at bus stops used by a number of different routes for the persons with disabilities to confirm that it is the appropriate bus being boarded.
- (ix) Some bus companies have installed audible next stop announcement and LED display inside compartment of some buses. Consideration should be given to extend this facility to more buses.

8.8.2.8 Regarding the provision of facilities for passenger with disabilities in buses, reference should be made to the recommended specification for low-floor buses by Disabled Persons Transport Advisory Committee (DPTAC), UK, and other guidelines issued by Transport Department.

Public light bus

8.8.2.9 To cater for the need of people with disabilities, public light bus (PLB) operators should provide the following facilities in their vehicles :

- (i) Seats should be reserved for the people with disabilities. The seat should be suitably placed inside the compartment;
- (ii) Installation of call bell on new PLB near the reserved seats to facilitate passengers with hearing and speaking impairment to inform the driver of their need to alight from the bus is being considered; and
- (iii) Installation of Braille and tactile vehicle registration mark plate should be installed on new PLB near the reserved seat to facilitate passengers with visual impairment to know the vehicle in case they want to lodge a complaint against the driver about the service is being considered.

Taxi

8.8.2.10 Under the “Certificate for Picking Up or Setting Down of Passengers with Disabilities in Restricted Zones” scheme, passengers with disabilities can board and alight from taxis in restricted zones except 24 hours restricted zones and expressways. They can apply for the Certificate for Picking Up or Setting of People with Disabilities in Restricted Zone from contact organizations under the co-ordination of Hong Kong Council of Social Service. Visually impaired passengers can fill in the Certificate in Braille.

8.8.2.11 Braille and tactile taxi registration mark plates are installed on the rear left hand door of the taxi to let visually impaired passengers know the registration number of the taxi in case they want to lodge a complaint about or to show an appreciation of the taxi service.

8.8.2.12 To facilitate passengers with visual impairment to know the taxi fare, talking taxi meter is being introduced.

8.8.2.13 To facilitate wheelchair users to board and alight from taxi, access ramps should be provided at taxi stands. Design of the access ramps for different footway width are shown in Diagrams 8.8.2.1 and 8.8.2.2. Details of footway width less than 2.8m is not provided because it is inappropriate to provide taxi stand for such narrow footways.

Ferry

- 8.8.2.14 At ferry piers ground level access should be available for the wheelchair users. If turnstiles are used, there should be an alternative means for the wheelchair users to gain access to the piers. On the ramps down to the ferry, transverse slats are often provided as a means of preventing pedestrians from slipping. Unfortunately these slats do make it difficult for the wheelchair users and therefore grooves, as shown in Diagram 8.8.2.3, should be cut in the slats. A proposal to provide a 900 mm passage way, which is painted in yellow, free of slats but line with anti-slip aluminium stripes across, is being considered.
- 8.8.2.15 Parking space for wheelchair users should be designated inside vessel. Call bells should be provided at the entrance of the ferry piers so that people with disabilities can call assistance from pier staff if and when necessary.

Rehabus

- 8.8.2.16 The Rehabus, which is operated by the Hong Kong Society for Rehabilitation, provides a territory-wide transport network to enable people with disabilities to travel to work and school, or participate in social and recreational activities, attend medical treatment, etc. The service uses specially adapted vehicles which are equipped with wheelchair restraint systems for wheelchair users and occupant restraints for other passengers with disabilities as illustrated in Diagram 8.8.2.4.

DIAGRAM 8.8.2.1 : TAXI STAND WITH ACCESS RAMP FOR PEOPLE WITH DISABILITIES
(FOOTWAY NOT LESS THAN 4.0m WIDE)

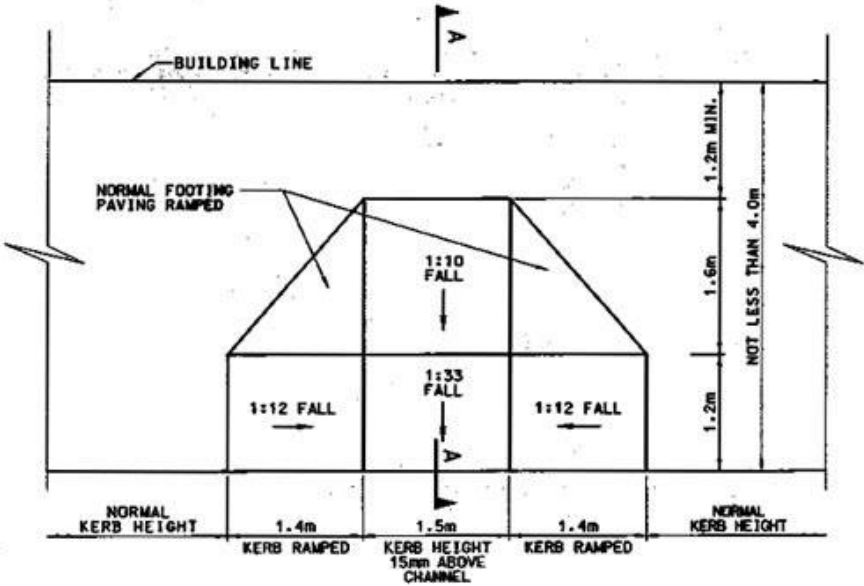

PLAN

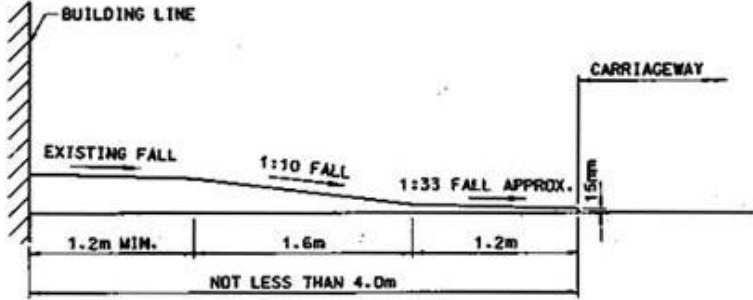
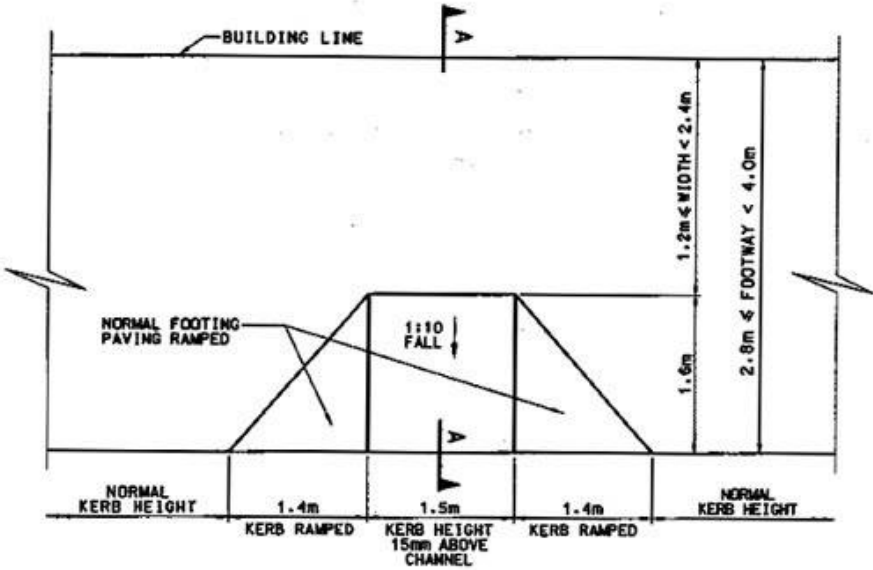

DIAGRAM 8.8.2.2 : TAXI STAND WITH ACCESS RAMP FOR PEOPLE WITH DISABILITIES
(2.8m ≤ FOOTWAY < 4.0m)



PLAN

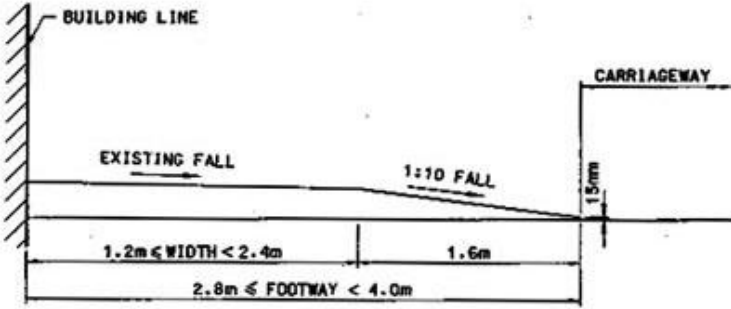
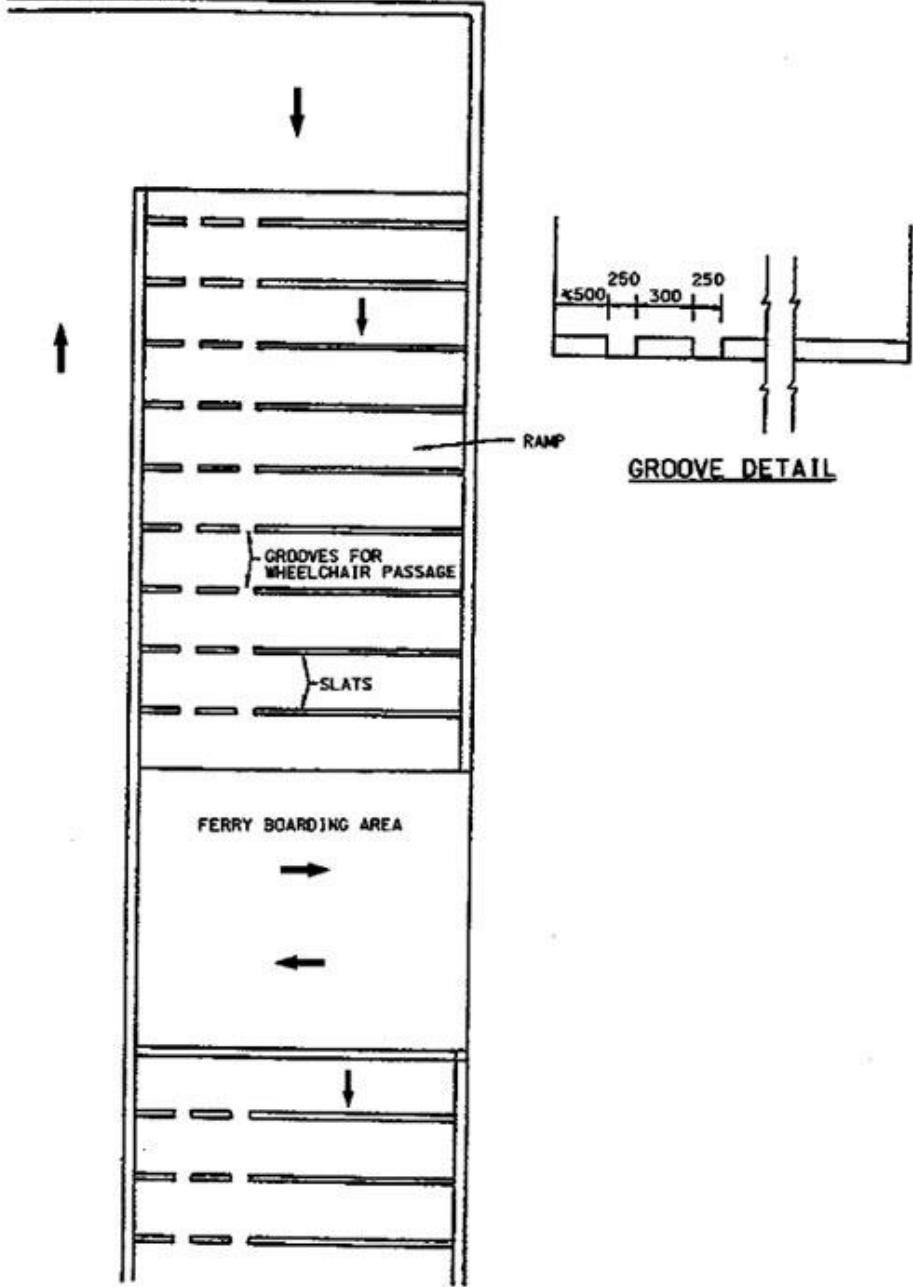

DIAGRAM 8.8.2.3 : GROOVED RAMPS FOR WHEELCHAIR PASSAGE AT FERRIES



ALL DIMENSIONS ARE IN MILLIMETRES

DIAGRAM 8.8.2.4 : WHEELCHAIR RESTRAINT SYSTEM

(a) 4 POINT WEBBING WHEELCHAIR RESTRAINT FOR ALLOY RAIL

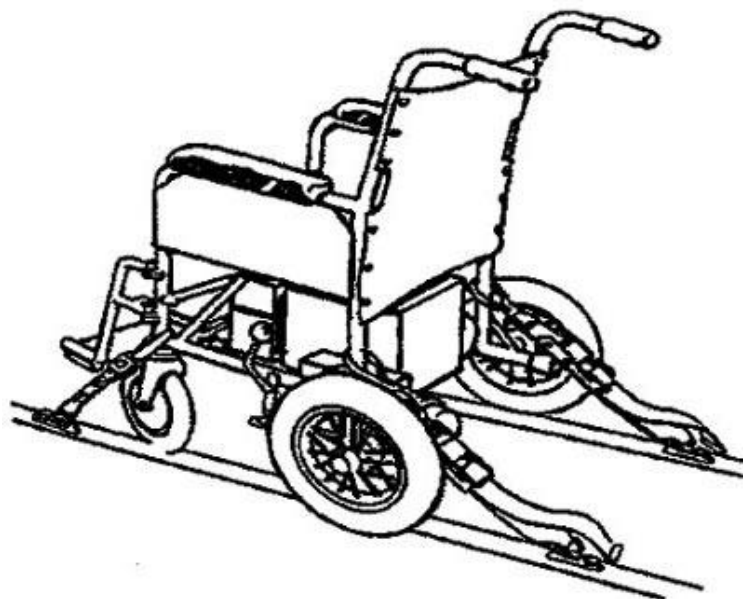

(b) EASILOK MK II



ALL DIMENSIONS ARE IN MILLIMETRES

Bus stop and public transport interchange

- 8.8.2.17 Bus stop should be as close to the kerb as possible. It is essential that there are no obstructions such as lamp columns, signposts or other street furniture within 500mm of the kerb where the bus stops are located.
- 8.8.2.18 We should facilitate access and movement of people with disabilities at all public transport interchanges including those located at the bus terminals, rail stations, and ferry piers. It should be noted that stairs are difficult for most people with disabilities to use and alternative lifts or ramps should be provided. Pedestrian crossing points within a public transport interchange should have dropped kerbs.

8.9 Public Transport Interchange

8.9.1 New major public transport interchange with cover

8.9.1.1 A layout of an accessible public transport interchange (PTI) is shown in Diagram 8.9.1.1.

DIAGRAM 8.9.1.1 : ACCESSIBLE FACILITIES IN COVERED PUBLIC TRANSPORT INTERCHANGE

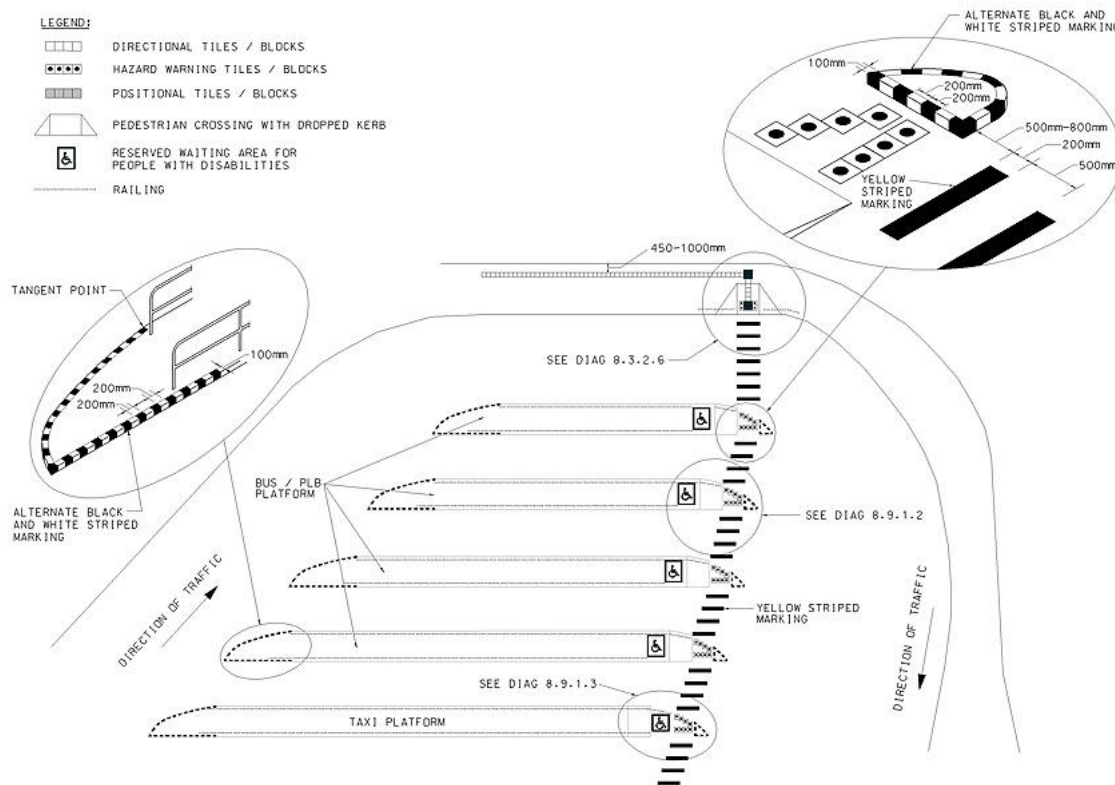

8.9.1.2 Tactile guide paths shall be provided within a major PTI to facilitate people with visual impairment to access all entrances/exits and boarding platforms of buses, taxis and/or public light buses via designated crossings. Detailed dimensions of the tactile tiles/blocks to be used and the basic patterns of tactile warning strips and guide paths are provided in Section 8.3.2 of this Chapter.

8.9.1.3 The tactile guide paths shall be provided at a distance of about 450 mm to 1000 mm from the back of the footway. Covers of utility services on the footway should be so positioned that they will not affect the guide path or the refuges as far as practicable. In case it is inevitable to place some services covers on the routes or any of the refuges, the recess covers should be provided with the matched tactile patterned tiles/blocks to make the guide paths continuous as far as practicable.

8.9.1.4 Approval should be sought from the maintenance authority of the major PTI before the use of the proposed tactile materials for the guide path. The colour of the tactile materials should be visually contrast with that of the adjacent pavement (e.g. yellow tactile tiles/blocks on grey/red footway, light-on-dark, dark-on-light, etc. but black tactile tiles/blocks are not desirable) to make the guide paths noticeable to people with low vision. In case of doubt, Commissioner for Rehabilitation and the Hong Kong Council of Social Service should be consulted.

- 8.9.1.5 The designated crossings to the boarding platforms of buses, public light buses and taxis should be aligned with the refuges at the front portion of the platforms so that they can form a continuous line of at grade crossings. The dropped kerbs at these crossings shall be flush with the carriageway and provided with tactile warning strips as illustrated in Diagram 8.3.2.6 but without audible traffic signal. Furthermore, gully gratings should not be located on the crossing area to avoid grating slots trapping wheels of wheelchairs and also confusing people with visual impairment.
- 8.9.1.6 Access ramps with a gradient not steeper than 1:12 shall be provided to facilitate wheelchair users to access the boarding platforms. Steeper gradient of up to 1:10 may be used if space is limited. Tactile warning strips should be placed at 300mm from the edge of the refuge to alert people with visual impairment of the potential hazard at the driveway ahead.
- 8.9.1.7 Details of the front portion of a boarding platform for buses and public light buses are illustrated in Diagram 8.9.1.2. To facilitate people with disabilities to board a bus with priority, a reserved waiting area of length 1.5 m shall be provided at the head of the queue with a yellow international symbol of accessibility. Where a major PTI is located in vicinity of workshops for people with physical handicap, consideration shall be given to providing a longer reserved waiting area of length 3 m for people with disabilities at each of the platforms within the major PTI. On the other hand, the conventional railings at the head of the queue may be modified by deleting the section of railing which is perpendicular to the kerbs so that people with disabilities could access that reserved area without difficulty.

DIAGRAM 8.9.1.2 : DETAILS OF FRONT PORTION OF PLATFORM FOR BUSES OR PUBLIC LIGHT BUSES

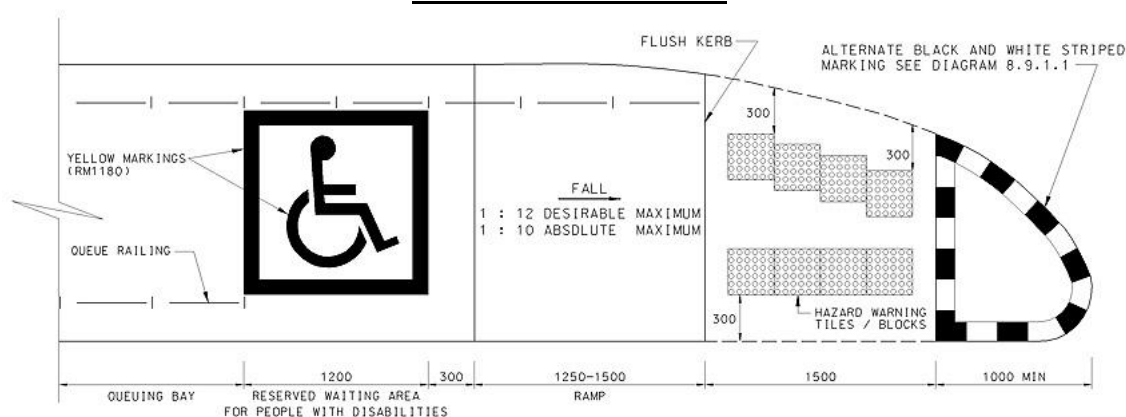

(NOT TO SCALE)

ALL DIMENSIONS ARE IN MILLIMETRES

- 8.9.1.8 For taxi boarding platform, a reserved waiting area for people with disabilities shall be accommodated in the refuge instead. Railings should be provided at the back of the waiting area to ensure people with visual impairment will not cross the area without knowing the potential hazard ahead. A typical detail of the taxi platform is shown in Diagram 8.9.1.3.

DIAGRAM 8.9.1.3 : DETAILS OF TAXI PLATFORM

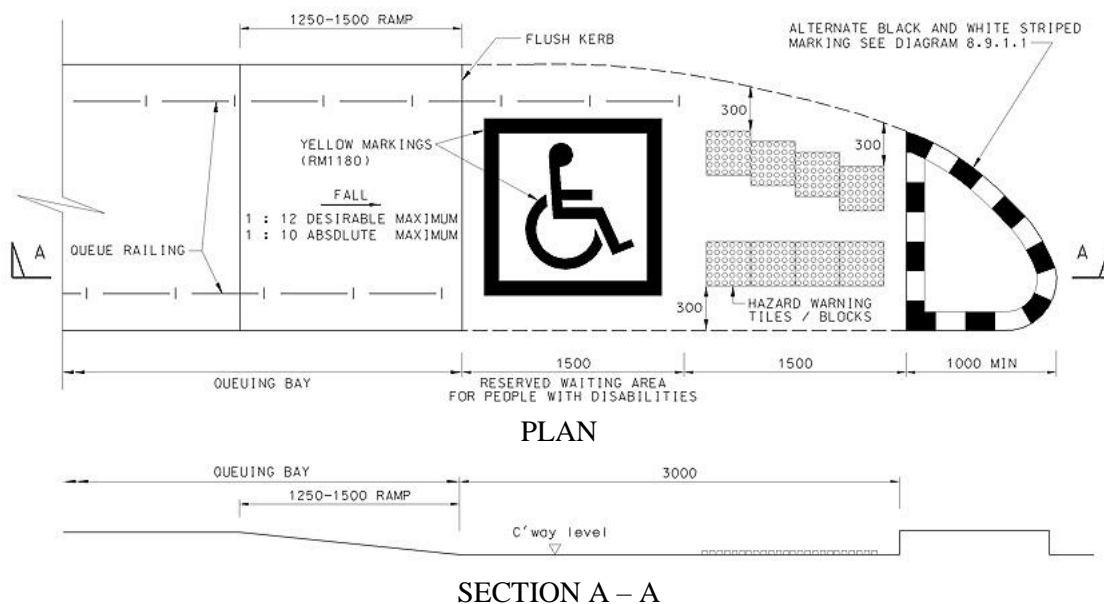

ALL DIMENSIONS ARE IN MILLIMETRES

- 8.9.1.9 If a common designated drop off point is provided, access ramp and tactile guide path should, as far as practicable, be provided to enable people with disabilities to access to all exits from it.
- 8.9.1.10 Tactile guide map and Braille routing information showing the information of the major PTI should be provided at the left hand side of each entrance to the PTI. The plate shall be erected at about 1.2m high. Disability organisations concerned should be consulted in respect of the design of the plate.
- 8.9.1.11 For major PTI with saw-tooth platforms, tactile guide paths shall be designed to lead to each of the boarding bays. In addition, an unobstructed clear pedestrian aisle of at least 2.4 m wide alongside the boarding platform shall be provided. A typical layout of this is shown in Diagram 8.9.1.4.

DIAGRAM 8.9.1.4 : ACCESSIBLE FACILITIES FOR SAW-TOOTH PLATFORM IN COVERED PUBLIC TRANSPORT INTERCHANGE

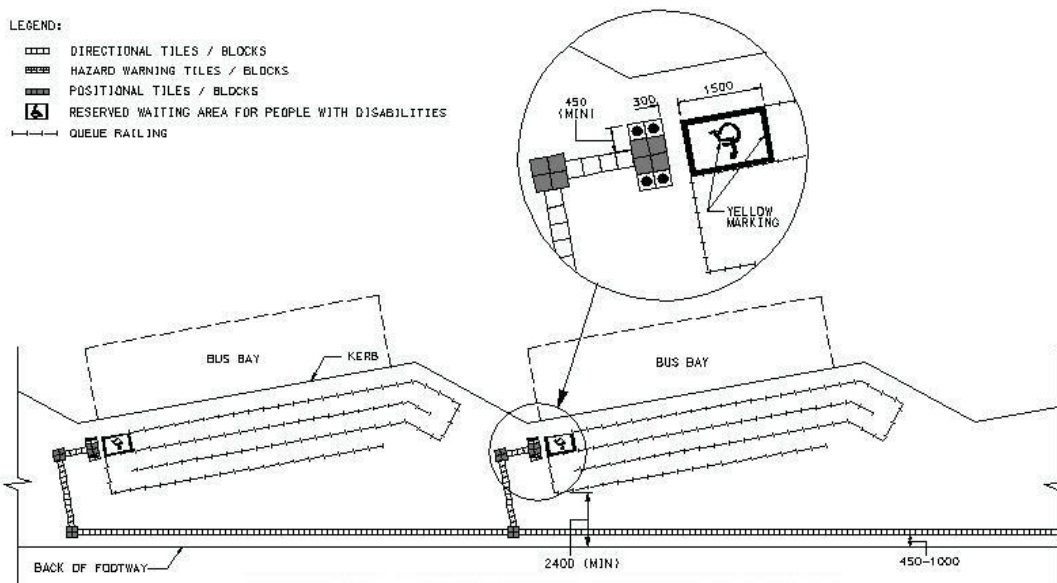

ALL DIMENSIONS ARE IN MILLIMETRES

- 8.9.1.12 Particular attention should be drawn to the provision of sufficient lighting to enable people with low vision to see clearly within a covered major PTI.

8.9.1.13 Facilities, such as public announcement system, should be available for public announcement of emergency message to people with disabilities including those with hearing or visual impairment.

8.9.2 New major public transport interchange without cover

8.9.2.1 The proposed provisions mentioned in Sections 8.9.1.1 to 8.9.1.13 above should also be applicable for new major PTI without cover except that the height of dropped kerbs for pedestrian crossings shall have a maximum height of 15mm.

8.10 Run-ins

8.10.1 Run-ins with High Traffic Flow

8.10.1.1 In general, the provision of tactile warning strip at run-ins should be considered only when the traffic flow is sufficiently high and the local circumstances warrant. Overuse of tactile warning strip at run-ins on street should not be allowed since proliferation of tactile warning strip on street will defeat its warning purpose.

8.10.1.2 The designers should exercise their own judgement taking into account the local circumstances when assessing a particular run-in. In general, run-ins to the following could be considered to have sufficiently high traffic flow :

- (i) Large petrol station;
- (ii) Shopping centre with a great number of parking spaces;
- (iii) Hospital;
- (iv) Large public car park; and
- (v) Residential development of a significant size.

8.10.1.3 The following factors should be taken into account when assessing whether the provision of tactile warning strip at a particular run-in is justified :

- (i) Speed of vehicles at the run-in;
- (ii) The availability of facilities near the run-in such as entrance gate, road hump, warning signs and signals, etc;
- (iii) Accident record;and
- (iv) The road environment near the run-in.

8.10.1.4 The typical arrangement for tactile warning strip at run-in with high traffic flow is illustrated in Diagram 8.10.1.1.

DIAGRAM 8.10.2.1 : TACTILE WARNING STRIP AT RUN-IN WITH HIGH TRAFFIC

FLOW
At Normal Run-in

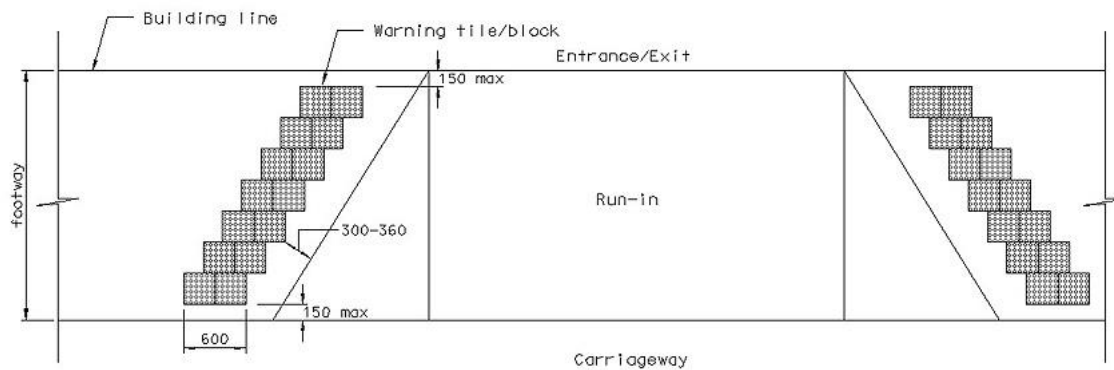

At Skew Run-in

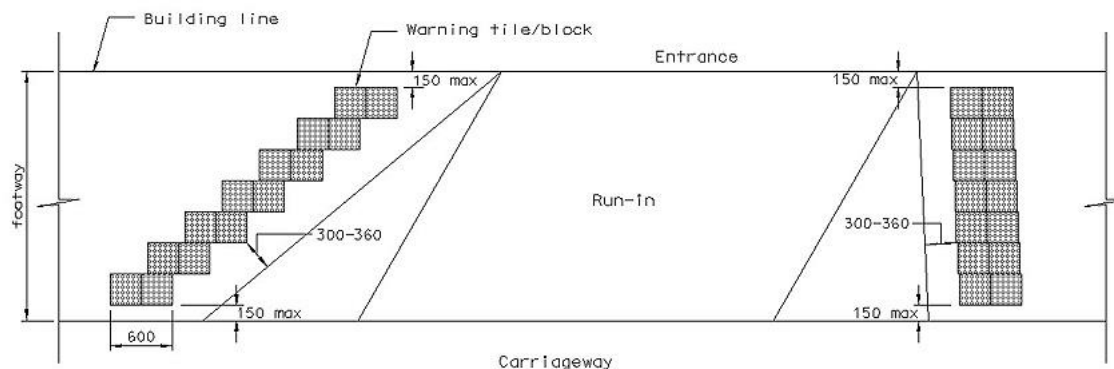

ALL DIMENSIONS ARE IN MILLIMETRES

8.10.2 Run-ins with Low Traffic Flow

8.10.2.1 It should be noted that proliferation of tactile warning strip on street will defeat its warning purpose. Sufficient justifications are required for the provision of tactile warning strips at a run-in with low traffic flow. Each situation should be assessed on its merits to decide whether or not tactile warning strips are necessary. When considered needed, the views of the concerned organizations for the people with disabilities should be sought and taken into consideration in making the decision.

TPDM Volume 6 Chapter 10 – Pedestrian Planning Framework

10.1 References and Abbreviations

10.1.1 References

- 1 1999 Policy Address
- 2 2017 Policy Address
- 3 2020 Policy Address Supplement
- 4 Mott MacDonald Hong Kong Limited, Reports and Working Papers prepared for the Transport Department on the “Consultancy Study on Enhancing Walkability in Hong Kong – Feasibility Study” under Agreement no. CE27/2017 (TT)
- 5 Planning Department, Hong Kong Planning Standards and Guidelines Chapter 8 on Internal Transport Facilities
- 6 Transport Department, Transport Planning and Design Manual, Volumes 2, 3, 5 and 6
- 7 Department of Environment, Transport and the Regions (DETR), Traffic Advisory Leaflets 1/01, Puffin Pedestrian Crossing
- 8 Fruin J J, Pedestrian Planning and Design, 2001
- 9 Ove Arup & Partners, Reports and Working Papers prepared for the Transport Department on the “Hong Kong Island North & Kowloon West District Traffic Study, “Additional Work – Pedestrian Schemes in Mong Kok, Tsim Sha Tsui and Causeway Bay” and “Additional Work 2 – Pedestrian Schemes in Central Wan Chai, Jordon and Shum Shui Po”, November 2001
- 10 Transport Department, Consultancy Brief: After-surveys for Review of Implemented Pedestrian Schemes in Causeway Bay, Mong Kok and Tsim Sha Tsui (TD51/2001)
- 11 DETR, Traffic Advisory Leaflets, 02/00: Framework for a Local Walking Strategy
- 12 DETR, Encouraging Walking, March, 2000
- 13 DETR, Traffic Advisory Leaflets 10/00, Road Humps: Discomfort, Noise, and Ground-borne Vibration
- 14 Institution of Civil Engineers, Designing Streets for People, Pre-Consultation Draft, September 2000
- 15 Institution of Highways & Transport, Guidelines for Providing for Journeys on Foot, 2000
- 16 Todd Litman, Traffic Calming Benefits, Cost and Equality Impacts, Victoria Transport Policy Institute, October 2000
- 17 Townland Consultant Limited, Reports and Working Papers prepared for the Planning Department on the “Study on Planning for Pedestrians” under Agreement no. CE12/2000
- 18 Transport Department, Road Safety and Standards Division, Road Traffic Accident Statistics 2000
- 19 Hong Kong Moving Ahead – A Transport Strategy for the Future, 1999
- 20 Institution of Highways and Transportation, Transport in the Urban Environment, ISBN 0 902933 21 3, June 1997
- 21 Transport Research Board, National Academy of Sciences, Highway Capacity Manual, Washington, D.C., 2016

10.1.2 Abbreviations

BDTM	Base District Traffic Model
CBD	Central Business District
DC	District Council
DETR	Department of Environment, Transport and the Regions, UK
DO	District Office
EPD	Environmental Protection Department
FEHD	Food and Environmental Hygiene Department
FSD	Fire Services Department
GMB	Green Mini Bus
HAD	Home Affairs Department
HCM	Highway Capacity Manual
HGV	Heavy goods vehicle
HKPF	Hong Kong Police Force
HKPSG	Hong Kong Planning Standards and Guidelines
HyD	Highways Department
kph	Kilometers per hour
LandsD	Lands Department
LCSD	Leisure and Cultural Services Department
LGV	Light goods vehicle
L/UL	Loading/ unloading
LOS	Level-of-Service
MGV	Medium goods vehicle
OPP	Outline Pedestrian Plan
PA	Policy Address
PFP	Pedestrian Framework Plan
PlanD	Planning Department
PPF	Pedestrian Planning Framework
PTI	Public Transport Interchange
PUFFIN	Pedestrian User-Friendly INtelligent
PWZP	Pedestrian Way Zonal Plan
RLC	Red Light Camera
TAL	Traffic Advisory Leaflets of DETR
TD	Transport Department
THB	Transport and Housing Bureau
TIA	Traffic Impact Assessment
TPDM	Transport Planning & Design Manual
TRL	Transport Research Laboratory
TUE	Transport in the Urban Environments of IHT

10.2 Introduction

10.2.1 General

- 10.2.1.1 This Chapter is a working guide that puts policy into actions in redressing the priority of the use of public roads for pedestrians with the key objective of fostering a pedestrian friendly environment to encourage people to walk more. It covers the new pedestrian planning framework (PPF) and pedestrian improvement measures formulated under the overall walkability strategy for Hong Kong (the Strategy).
- 10.2.1.2 The 1999 and 2017 Policy Addresses (PAs), and 2020 PA Supplement put greater emphasis on the needs of the pedestrians in transport planning and on taking forward pedestrian planning and pedestrian improvement initiatives/measures in a more holistic and coordinated manner. Pursuant to the 1999 PA, the Transport Department (TD) has in the early 2000s improved the existing pedestrian facilities through the implementation of area-wide pedestrian schemes in Causeway Bay, Central, Jordan, Mong Kok, Sham Shui Po, Sheung Shui, Stanley, Tsim Sha Tsui, and Yuen Long. The 2017 PA encouraged people to walk more so as to reduce the use of motorised transport for short-distance commuting and promulgated the “Walk in Hong Kong” initiatives with the implementation of walkability enhancements to promote walking along four pillars namely (i) making it connected; (ii) making it safe; (iii) making it enjoyable; and (iv) making it smart. To this end, various pedestrian improvement initiatives/ measures were taken forward by the TD and other departments. The Strategy embraces a paradigm shift in pedestrian planning from a vehicle-centric to a pedestrian-centric approach, with the vision of developing Hong Kong into a walkable city.
- 10.2.1.3 The guidelines are largely based on the Strategy developed in the course of the Consultancy Study on Enhancing Walkability in Hong Kong (Reference 4), which has made reference to international best practices and relevant local guidelines, standards and practices. They have also consolidated past efforts and new pedestrian improvement measures adopted by the TD and relevant departments.
- 10.2.1.4 A new PPF has been established by adopting a plan-based approach in integrating the four pillars of walkability by way of the preparation of Outline Pedestrian Plans (OPPs), the primary function of which is to translate the Strategy into pedestrian plans and pedestrian improvement measures at the district and local levels. Existing guidelines/standards for pedestrian improvement measures are also reviewed/updated.
- 10.2.1.5 Walking itself is not to eliminate other modes of transport, but to offer a greener and healthier alternative. To supplement the pedestrian network, there should be a balanced package of measures for traffic management and parallel improvement works on the road network and junctions, not simply a restriction on motorists. The guidelines in this chapter are not prescriptive and additional initiatives may be added and flexibility allowed to reflect specific planning context, planning circumstances and community aspirations of the district/ area.
- 10.2.1.6 Reviews should be carried out when necessary to ensure that the pedestrian planning proposals and the pedestrian improvement measures have been fulfilled and, if necessary, suitable adjustments could be made to accord with the changing circumstances.

10.2.1.7 This chapter is structured with six sections as follows:

Section 10.1	References and Abbreviation
Section 10.2	Introduction
Section 10.3	Highlights of the Overall Walkability Strategy for Hong Kong
Section 10.4	Pedestrian Planning Framework (including Appendix A which provides guidelines on formulation process of OPPs)
Section 10.5	Design of Pedestrian Improvement Measures (including Appendix B which provides the list of pedestrian improvement measures under the four pillars of walkability for reference)
Section 10.6	Performance Review

10.3 Highlights of the Overall Walkability Strategy for Hong Kong

10.3.1 The Strategy

10.3.1.1 Vision

10.3.1.1.1 The vision of the Strategy is to develop Hong Kong into a walkable city.

10.3.1.1.2 The vision embodies the value of placing high priority on pedestrians in transport planning, fosters a pedestrian friendly environment, and promotes walking as a form of sustainable mobility to bring about transport, social, environmental, economic and health benefits as set out below:

- (i) Transport perspective – reduces travel demand and travel distance by motorised transport through integrating land use and transport planning to promote walking as a preferred means of travel, promotes walking and public transport as a preferred mode of transport for commuting, school trips and leisure trips, and provides ease of access between developments, different transport modes and different pedestrian networks;
- (ii) Social and health perspectives - promotes walking as a part of an active and healthy lifestyle to improve health and wellbeing, provides affordable mobility, encourages social interaction and street vibrancy, and facilitates more independent mobility for the ageing population and more vulnerable groups;
- (iii) Economic perspective – increases foot traffic for commercial, retail and other economic activities, supports local economy, and alleviates economic impact of traffic congestion; and
- (iv) Environmental perspective – reduces reliance on motorised transport to reduce carbon emission, reduces traffic congestion and air pollution, and improves urban climate and the street environment.

10.3.1.2 Strategic spatial components to deliver a walkable Hong Kong

10.3.1.2.1 Hong Kong is a densely populated city and an international finance and business hub. It also has many invaluable green and blue assets which are of particular importance to the compact urban core. The strategic spatial components of a walkable Hong Kong consist of walkable Central Business Districts (CBDs), walkable districts and towns, and walkable blue and green links.

- (i) Walkable CBDs - A walkable CBD should be easily accessible by strategic transport infrastructure, be efficiently integrated with the public transport hubs by walking, include multi-level connection for efficient and convenient pedestrian movement, be provided with adequate footpath capacity for high pedestrian volume, be designed with attractive pedestrian realm for interaction, etc.
- (ii) Walkable Urban Districts and Towns - A walkable urban district/ town should have convenient access for daily convenience within walking distance, ease of first mile and last mile travel by pedestrian links to public transport nodes, provision for walking as part of an active and healthy lifestyle, and enjoyable leisure experience with the green and blue assets in the urban district/ town.
- (iii) Walkable Green and Blue Links - Walkable green and blue links comprise connected and accessible pedestrian links to or through green and blue assets. Green assets refer to open space, green space, the urban fringe, the countryside and country parks; green connectors such as landscaped links and walking trails; and other green features. Blue assets refer to the harbourfront, the riverfront, conservation related water space (such as wetland park), blue connectors such as waterfront promenade, and other blue features.

The nature, form and scale of strategic spatial components vary across different districts which have their own history, function and characteristics. They should be duly reflected with different emphasis as appropriate in the pedestrian planning and pedestrian improvement measures.

10.4 Pedestrian Planning Framework

10.4.1 Purpose

10.4.1.1 A pedestrian planning framework (PPF) has been developed under the overall walkability strategy for Hong Kong (the Strategy) with the purpose of translating the Strategy into pedestrian plans and pedestrian improvement measures at the district/ local level.

10.4.2 Pedestrian Planning Issues

10.4.2.1 The walking environment in Hong Kong has many challenges arising from limited pedestrian space and competing demands by different road users. Walking may be deterred by the hot, humid and rainy weather, the conflict between vehicles and pedestrians as well as the hilly topography of some neighbourhoods. Mobility needs of the ageing population and the physically challenged also pose special pedestrian design requirements.

10.4.2.2 A list of common walkability issues at the district/ local level has been identified under the four pillars of walkability. They may be addressed in the application of the PPF and formulation of pedestrian improvement measures:

Making it connected

- (i) Walking time and distance - 300-500 m or 10 to 15 -minute walking time is defined as the appropriate walking regime for most essential and normal day-to-day travel. Allowance should be made for sloping topography and hot and wet climate which reduce the walking catchment. Shade, shelter, mechanical walking assistance such as escalators and travelators and measures mitigating risk on a sloping or stepped street, on the other hand, may encourage people to walk further.
- (ii) Missing links - A missing link may be a missing pedestrian connection, a lack of visual access to a destination, or a lack of barrier free access for the physically challenged or other vulnerable pedestrian groups.
- (iii) Multi-level connection – At the urban core, multi-level pedestrian connection is necessary to form a comprehensive pedestrian network integrating walking with public transport hubs and other destinations with efficiency, convenience and an attractive walking environment. These could not be achieved by standalone footbridges or subways.
- (iv) Integration with public transport – As public transport makes up 90% of the modal share in daily trips, continuous pedestrian connections to public transport nodes should be provided to facilitate the first mile and last mile travel.
- (v) Inclusive mobility – An inclusive design principle should be adopted to cater for pedestrians of all ages and abilities.

Making it safe

- (i) Vehicle speed – Imposing vehicle speed limit is not only for road safety but also to manage vehicle speed for helping eliminate pedestrian fatalities and severe injuries in traffic accidents. Lower speed limit is considered necessary especially in neighbourhoods with more vulnerable pedestrian groups such as school children and the elderly.
- (ii) Traffic calming – To enhance pedestrian safety, vehicles are slowed down to give pedestrian priority for road use through road design.
- (iii) Perception of security – Enhancements such as better lighting and active building frontage could be implemented to provide a safe and attractive walking environment as perceived by the pedestrians.

Making it enjoyable

- (i) Inadequate capacity – Pedestrian congestion or overspilling of pedestrians onto the carriageways may be a result of inadequate footpath capacity due to heavy pedestrian flow, narrow footpath, uncoordinated allocation of space for bus stops and competing use of limited space which could be increased to prioritize pedestrian needs.
- (ii) Street clutters – Non-essential railings, road signs and traffic signs and excessive street furniture further reduce the effective footpath width, flow capacity and quality of the pedestrian environment.
- (iii) Pedestrian comfort under sub-tropical climate – The hot, humid and rainy weather under the subtropical climate discourages people to walk more and to walk further. The extreme weather brought by climate change will compound the problem. Weather protection in the form of building canopies, tree shades, covered walkways and a weather proof comprehensive walkaway system may be considered to make walking more comfortable.
- (iv) Quality of the walking environment – The pedestrian realm in Hong Kong as a public space is often with minimal streetscape design and pedestrian amenities. The place function of pedestrian ways along or around nodes of attraction could be enhanced to make these pedestrian ways by themselves an enjoyable destination.

Making it smart

- (i) Wayfinding – Legible walking routes with the aid of coherent and clear wayfinding signage help pedestrians reach their destinations more easily.
- (ii) Pedestrian route and modal choice – The use of technology should be leveraged to help pedestrians navigate their walking routes and make modal transfer more efficient.

10.4.3 Pedestrian Planning Objectives

10.4.3.1 The pedestrian planning objectives serve as the overarching principles to guide pedestrian planning and pedestrian improvement measures under the PPF to achieve the four pillars of walkability.

Making it connected

- (i) Continuity – Provision of crossings to achieve continuous pedestrian routes.
- (ii) Accessibility – Easy access (preferably with direct route) for population to reach key community facilities by walking.
- (iii) Integration with public transport – Easy connection to key public transport nodes by walking.
- (iv) Permeability – Permeable urban fabric for walking¹.
- (v) Multi-level connection – Easy pedestrian connection to destinations through different levels in urban core.
- (vi) Inclusive mobility – Wheelchair access along pedestrian routes, barrier free access at junctions and level changes, and barrier free access to MTR stations, public transport interchange and terminals.

Making it safe

- (i) Eliminating all pedestrian fatalities and severe injuries in traffic accidents.
- (ii) Rebalancing priority for pedestrians – Reduced conflict with vehicular traffic by traffic calming, and an inclusive pedestrian environment for the vulnerable groups.
- (iii) Perception of security – Vibrant pedestrian routes to reduce potential for crime.
- (iv) Safe sloping/ stepped streets – Measures to mitigate hazards of pedestrian ways.

Making it enjoyable

- (i) Capacity – Sufficient space for pedestrians.
- (ii) Comfort – Comfortable walking environment.
- (iii) Healthy – An improved walking environment to promote better health and well-being with more active walking habit and outdoor lifestyle.
- (iv) Attraction – Pedestrian way as a destination by itself.
- (v) Coordination – Coordinated space allocation for walking and public transport mode.
- (vi) Connection to nature – Pedestrian connection to or through green and blue assets².

¹ In order to provide a fine urban grain and permeable pedestrian network, the block length or sub-block length along a street block is preferably less than 150m.

² Section 10.3.1.2.1 (iii) of TPDM Volume 6 Chapter 10 provides detailed description of green and blue assets.

Making it smart

- (i) Legibility - Ease of wayfinding through physical signage.
- (ii) Interactive planning – Ease of route planning and wayfinding through the use of technology.
- (iii) Smart pedestrian infrastructure – Prioritising pedestrian movement through the use of technology.
- (iv) Automated collection of pedestrian flow data and pedestrian environment data.

10.4.4 Latest Approach for Pedestrian Planning

10.4.4.1 A comprehensive PPF which integrates traffic, transport, land use and walkability is developed. Pedestrian planning and pedestrian improvement measures should not only address the pedestrian ways and pedestrian realm but also the adjacent land uses, building frontage, public transport, cycling, loading/ unloading, vehicle parking, road layout and vehicular movements all having a bearing on walkability. There could be more considerations on enhancing pedestrian experience to address long-term pedestrian needs.

10.4.4.2 The new approach for pedestrian planning under the PPF embraces a paradigm shift in pedestrian planning and design from a vehicle-centric to pedestrian-centric approach. It comprises the following key concepts;

- (i) Urban grid for mobility³- The concept recognizes the relative priorities for motorized transport and pedestrians in the respective parts of the road network as an urban grid with higher priority for vehicular movement in the outer grids and higher priority for pedestrians in the inner grids;
- (ii) Link and Place approach for pedestrian ways – The approach serves to meet both the link and place functions of the pedestrian ways. This is the concept that streets provide for both the through movement of people, via all modes (Link), and that streets also function as destinations in their own right (Place), which may attract a range of people to the street due to its pleasant environment and/or adjacent land-uses. With the identification of link and place significance of the pedestrian routes, the corresponding pedestrian improvement measures could be suitably determined according to a Link and Place Typology matrix ⁴;
- (iii) Three zone concept and new minimum footway width requirement – The concept and new requirement integrate the relative significance of the link and place function in the three pedestrian zones of the footway i.e. the building frontage zone, through zone, and street furniture and greening zone. The through zone has a higher priority on the link function while the other two zones have a high priority on the place function. The new minimum footway width requirement, which could be found in Annex E of Appendix A under TPDM Volume 6 Chapter 10, has integrated the link and place significance and other relevant considerations in respective pedestrian zones; and
- (iv) Plan based approach for pedestrian planning and design – Developing pedestrian plans and pedestrian improvement measures in a holistic and coordinated manner for the districts/ areas are achieved by way of the Outline Pedestrian Plans (OPPs).

³ One of the intents of the concept is to limit vehicular access to the inner grids, which could be the pedestrian priority/traffic calming areas, except for loading/unloading and servicing, through traffic and non-essential traffic deterred from entering into and/or travelling through the study areas. Traffic restraint measures may apply and the likely traffic reassignment at parallel routes should be investigated with assessments of the traffic and transport impacts (TIAs) in order to support the pedestrian priority/traffic calming areas.

⁴ The Link and Place Typology is to provide an overall picture of the combined link and place significance of the pedestrian routes. Each pedestrian route will be assigned a category in accordance with its relative link and place priorities in the 3x3 Link and Place Typology matrix, to provide the basis for determining the corresponding pedestrian improvement measures in the next step. See details in **Appendix A**.

10.4.5 Application of the PPF

New Development Areas

10.4.5.1 In new development areas (NDAs), the planning and design of the public roads and the application of the new minimum footway width requirement are typically not constrained by existing developments. Integration of pedestrian facilities with developments and public transport nodes to form a comprehensive pedestrian system should be feasible with advance planning. As considered appropriate, the PPF could be applied through the preparation of OPPs in the planning and engineering feasibility studies, urban design study, detailed design and other relevant studies for the NDAs. The pedestrian improvement measures derived from the preparation of OPPs could be implemented through public works and the planning, lands and building regimes where appropriate. Pedestrian facilities involving private lots may include building canopies, building setback for the provision of sufficient footpath width, public passageways, elevated, at grade and underground pedestrian links, streetscape enhancement, etc.

Existing Built-up Areas

10.4.5.2 Opportunities should also be taken to apply PPF following similar approach in considerable scale comprehensive new urban developments and urban regeneration projects with replanning and land use restructuring (e.g. district based urban renewal schemes, street block consolidation and restricting schemes, and areas whereby an urban grid for mobility as mentioned in Section 10.4.4.2 (i) could be identified).

10.4.5.3 For some strategic and major pedestrian corridors in existing built-up areas, to rebalance priority for pedestrians, reclaiming space from carriageways or requiring building setback for footpath widening to achieve the new minimum footway width requirement, part time or full time pedestrianisation, implementing traffic calming measures, etc. without adverse impact on vehicular traffic may be considered. Pedestrianisation scheme if considered should be seriously assessed with due regard to its land use compatibility with the neighbourhood and public views to avoid nuisances to nearby occupants and public criticisms. The new minimum footway width requirement and pedestrian improvement measures involving private lots including building canopies, building setback for footpath widening, public passageways and pedestrian links, streetscape enhancement, etc. may be incorporated into new developments and redevelopments when opportunities arise and could be implemented through the planning, lands and building regimes where appropriate.

10.4.6 Outline Pedestrian Plans (OPPs)

10.4.6.1 The OPPs consist of a Pedestrian Way Zonal Plan (PWZP) and a Pedestrian Framework Plan (PFP) with explanatory notes.

Pedestrian Way Zonal Plan (PWZP)

The PWZP provides general guidance for pedestrian zones (including space reservation, pedestrian facilities, design, management and up-keeping guidelines) for different categories of pedestrian ways corresponding to their relative link and place priorities under the Link and Place Typology matrix. In general, one typical profile of the pedestrian zones should be prepared for each category of pedestrian way in the typology matrix. Therefore at least nine profiles should be drawn up for the PWZP.

Pedestrian Framework Plan (PFP)

The PFP outlines the planning vision, pedestrian design concepts, planned pedestrian network and pedestrian improvement measures in different locations of the concerned pedestrian network also corresponding to their relative link and place priorities under the Link and Place Typology.

The PFP is accompanied by a set of explanatory statement that sets out the planning concept, planning intentions and planning objectives, which are then translated into location-specific interventions from the Pedestrian Improvement Plan⁵. The PFP shows mainly the urban grid for mobility, the planned pedestrian network with pedestrian routes, and the pedestrian improvement measures corresponding to the Link and Place Typology, the key walkability enhancement areas, implementation and other relevant considerations.

The explanatory statement accompanying the PFP is to set out the pedestrian planning and pedestrian improvement proposals in context, which comprises the following key components:

- Introduction and Background
- Planning Vision
- Pedestrian Design and Landscape Concepts
- Challenges and Opportunities
- Pedestrian Planning Intention and Objectives
- Application of new Pedestrian Planning Approach and Design
- Key Walkability Enhancement Areas
- Implementation

10.4.7 Formulation of OPPs

10.4.7.1 The formulation of OPPs involves three major steps:

- (i) **Data Collection:** It covers defining the Planning Area, analysing land uses relevant to pedestrian planning, stocktaking pedestrian routes, reviewing the road hierarchy and public transport corridors, and collecting the link and place data and analysing their significance. The process involves the formulation of Planning Area Plan, Land Use Plan, Public Transport Route and Road Network Plan, Pedestrian Route Plan, Place Data and Significance Plan and Link Data and Significance Plan.
- (ii) **Urban Analysis:** It comprises the urban design appraisal of the Planning Area, the delineation of urban grids for placing higher priority for pedestrians in relevant part of the road network, the formulation of the planned pedestrian network, the analysis of the relative priorities for the link and place function of the pedestrian routes on the pedestrian network, and devising pedestrian improvement measures in accordance with their link and place significance. The process of urban analysis generates Urban Design Plan, Urban Grid Plan, Pedestrian Network Plan, Link and Place Typology Plan and Pedestrian Improvement Plan.
- (iii) **Preparation of the OPPs:** It involves the preparation of PWZP supplemented by specific guidance for each category under the Link and Place Typology and PFP supplemented by an explanatory statement setting out the planning context, planning intention, planned pedestrian network and associated pedestrian improvements, together with the key features identified in the urban analysis to govern the design and implementation.

The detailed formulation process of OPPs is set out in **Appendix A**.

⁵ The Pedestrian Improvement Plan shows all pedestrian improvement measures which are proposed to enhance the walking environment, as a result of the overall pedestrian planning exercise for a specific OPP area. See details in **Appendix A**.

- 10.4.7.2 The implementation of the OPPs adopt an integrated approach addressing the land use planning, public transport, pedestrian facilities, loading/unloading, access right, parking requirements and traffic management schemes/restrain measures as appropriate. It requires collaborative efforts in the planning, land, building, traffic and other relevant regimes. After suitably considering the pedestrian improvement proposals for the pedestrian priority areas with the support of the traffic review/ TIA, such proposals could be incorporated into the urban design, preliminary/recommended outline development plans, land lease and/or whatever applicable to the NDAs and the existing built-up areas as far as possible.
- 10.4.7.3 The methodology for the formulation of OPP set out above is not prescriptive and additional initiatives can be added and some flexibility allowed to reflect specific planning context, planning circumstances and community aspirations of the district or area.
- 10.4.7.4 Please refer to Section 10.5 for details regarding design of pedestrian improvement measures.

Appendix A

Formulation Process of Outline Pedestrian Plans (OPPs)

1. Overview

1.1 The formulation of OPPs encompasses the following three major steps:

- Step 1 – Data collection
- Step 2 – Urban analysis
- Step 3 – Preparation of the OPPs.

1.2 An overview of the key steps of the planning process and the key outputs for the OPPs is shown in **Figure 1**.

2. Step 1 - Data Collection

2.1 The data collection process covers defining the Planning Area, analysing land uses relevant to pedestrian planning, stocktaking pedestrian routes, reviewing the road hierarchy and public transport corridors, and collecting the link and place data and analysing their significance. The process involves the formulation of Planning Area Plan, Land Use Plan, Public Transport Route and Road Network Plan, Pedestrian Route Plan, Place Data and Significance Plan and Link Data and Significance Plan.

2.2 Planning Area Plan

2.2.1 A Planning Area Plan shows the extent of the Planning Area, the planning unit of an OPP which may cover an existing built-up area or a new development area (“NDA”). It would be beneficial to align existing or potential pedestrian planning areas within the same District Council District and with key connecting physical features such as major roads, major pedestrian spines, major blue and green links or neighbourhood boundaries.

2.3 Land Use Plan

2.3.1 A Land Use Plan consists of the existing and planned land uses within the OPP, based on the available Outline Zoning Plans (“OZP”) and/or relevant Outline Development Plans (“ODPs”) supplemented by on-site observations and relevant land use surveys for the existing built-up areas.

2.3.2 The Land Use Plan comprises:

- Existing and planned land uses;
- Planned development/ redevelopment projects;
- Major facilities (including educational facilities, community facilities, medical facilities, heritage, government facilities, transport hubs, etc.);
- Designated non-building areas and commercial frontages;
- Open space; and/or
- Committed and planned pedestrian improvements.

Figure 1: Overview of the Planning Process and key outputs for OPPs

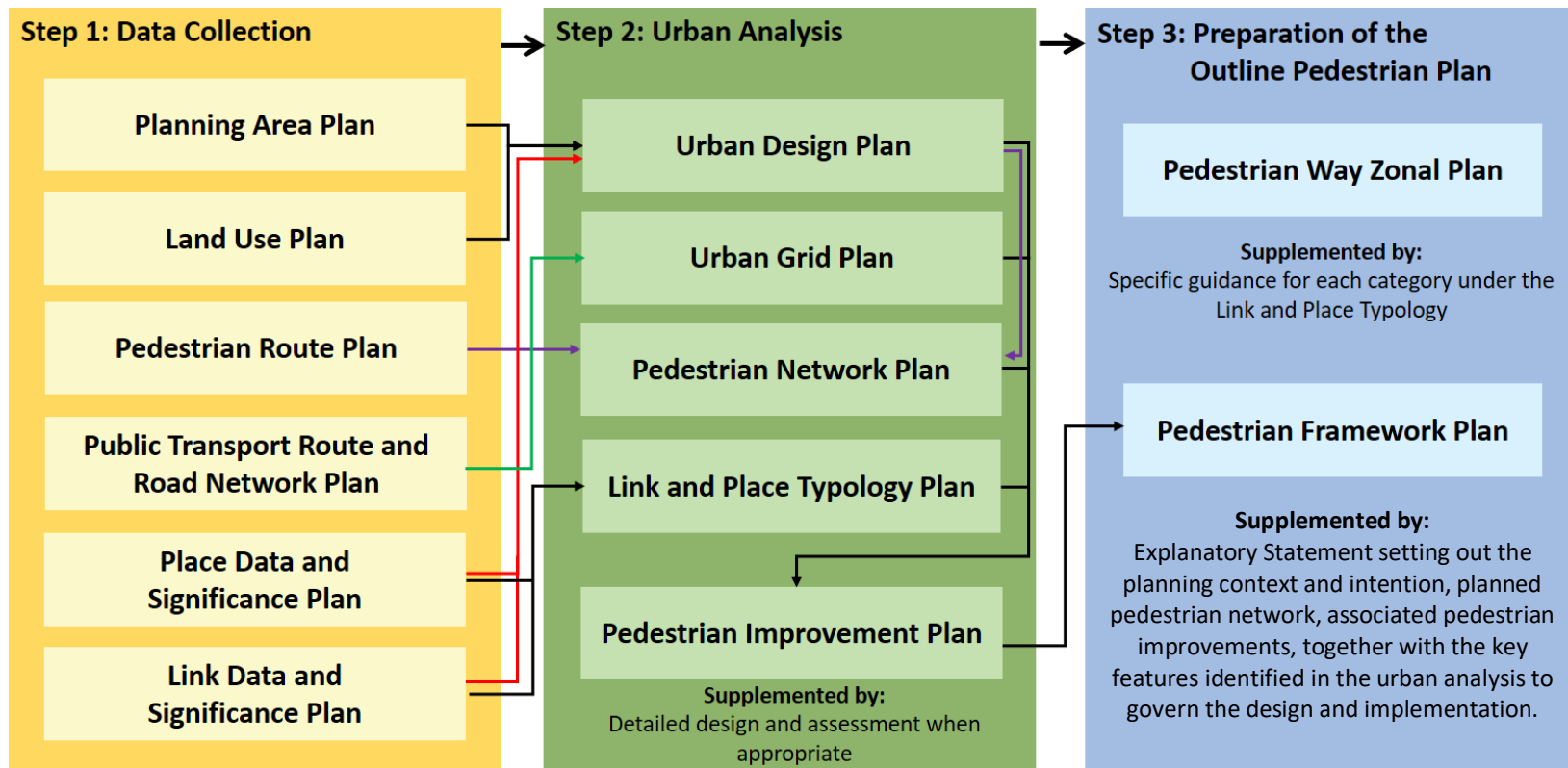

2.4 Pedestrian Route Plan

- 2.4.1 A pedestrian route can be at grade, elevated or underground, along the road or passing through buildings or public spaces.
- 2.4.2 A Pedestrian Route Plan shows existing and planned pedestrian routes within the Planning Area, based on pedestrian route geographic information system (“GIS”) data, survey maps, on-site observations, the available Planning and Engineering (“PE”) Study Report, OZPs and/or ODPs, planning briefs for proposed developments/ comprehensive redevelopments, desktop research, etc.
- 2.4.3 The Pedestrian Route Plan consists of existing and planned elevated, underground or at-grade pedestrian routes, including those 24-hour public passageways within developments. Other relevant information includes the availability of building canopies, covered walkways, trees or commercial frontages along the routes, accident statistics, etc., where appropriate.
- 2.4.4 In the NDAs, pedestrian routes on each side of the road may need to be analysed as there may be difference in the nature and intensity of the land uses.

2.5 Public Transport Route and Road Network Plan

- 2.5.1 A Public Transport Route and Road Network Plan is prepared to reflect the existing and planned vehicular traffic network and public transport networks, based on information on existing road network, road hierarchy and public transport routes, available PE Study Reports and Traffic Impact assessment (“TIA”) reports, etc.
- 2.5.2 The Public Transport Route and Road Network Plan consists of:
- Existing and planned vehicular traffic network, showing road hierarchy, i.e. primary distributor, district distributor and local roads;
 - Entrances of MTR stations and areas within 500m walking distance from the stations in the vicinity;
 - Existing and planned major public transport routes, in particular key road based public transport corridors; and/or
 - Existing and planned major transport hubs.

2.6 Place Data and Significance Plan

- 2.6.1 Pedestrian way can be a destination in its own right, where people are attracted and encouraged to spend time thereat due to its pleasant environment, urban experience and/or adjacent land-uses.
- 2.6.2 A place is a node that generate pedestrian activities along or around the pedestrian ways including (1) Activity Nodes; (2) Character Streets and Links; (3) Public Space (4) Transport Nodes.
- 2.6.3 The higher the place significance, the further people are willing to travel to (i.e. catchment) or the more nodes of activities (i.e. clustering) are attracting people to visit. It often results in a vibrant pedestrian realm. Three levels of significance are described below:
- High: A pedestrian way that will have significant clustering of places (Activity Nodes, Character Streets and Links, Public Space and/or Transport Nodes) attracting territory-wide catchment and activities with high vibrancy.
 - Medium: A pedestrian way that will have some clustering of places attracting district-wide (and at-most neighbouring district) catchment and activities with medium vibrancy.
 - Low: A pedestrian way that will have a predominantly local function with a local catchment and activities and low vibrancy.
- 2.6.4 The place significance of a pedestrian way is determined by catchment size and clustering of the nodes and the expected vibrancy level.

Catchment size

- 2.6.5 Catchment refers to how far people typically travel to reach specific node(s) as their destination(s) and they can be categorised as territorial, district and local catchments. The details of nodes of different land use types and catchment sizes are summarized in **Annex A**.

Clustering

- 2.6.6 Clustering refers to the agglomeration of two or more nodes along or around the pedestrian route. The clustering can be dense or sparse.

Level of Vibrancy

- 2.6.7 Vibrancy refers to how people interact with the pedestrian way in terms of dwell time and the amount of activities. It captures an agglomeration of nodes (or facilities), the presence of active frontage and the extent of stationary or other activities. The vibrancy level for a place consists of high, medium and low levels. The details of nodes of different land use types and vibrancy levels are summarized in **Annex A**. The vibrancy of the existing built-up area also is to be ascertained by on-site observations.
- 2.6.8 After deducing the catchment size, clustering and vibrancy level, the place significance would be worked out from **Table 1** below.
- 2.6.9 A flow chart summarising the steps to determine the place significance for a section of footpath is given in **Annex B**

Table 1. Place significance

		Level of Vibrancy		
		Low	Medium	High
Catchment Size	Territorial	Subject to review*	P2	P3
	District	P2	P2	P3
	Local	P1 (without clustering) P2 (with clustering)	P2	Subject to review*

* The catchment size for the node appears not matching with its level of vibrancy. The place significance would be reviewed on case by case basis.

2.7 Link Data and Significance Plan

- 2.7.1 Pedestrian ways also facilitate movement of people from one place to another. A link includes pedestrian connections between nodes and local access to a neighbourhood. The link significance is combined with the place significance to form the Link and Place Typology,

- 2.7.2 Link significance illustrates the importance of the pedestrian way within the pedestrian network. The link with high link significance typically connects major destinations or has high usage in terms of pedestrian volume. Three levels of significance are described below:

- High: A pedestrian way that performs a major link function providing direct connections between major nodes and has high pedestrian volume.
- Medium: A pedestrian way that performs a minor link function connecting major node and minor node, or between minor nodes, and has medium pedestrian volume.
- Low: A pedestrian link that is locally oriented, providing connection to local destinations, and has low pedestrian volume.

- 2.7.3 The link significance of a pedestrian way is determined by link function of a pedestrian route between

nodes with various movement levels. For the existing built-up area, pedestrian flow data may be collected to provide a benchmark for the variation of pedestrian volume across different level of link significance. For the NDA, a more comprehensive approach might be adopted by referencing a pedestrian flow model for the NDA as part of planning and engineering feasibility study whenever available.

- 2.7.4 The movement level for nodes of different land use types is shown at **Annex C**. In determining the link function along a footpath, the nodes¹ along the footpath and those at the end of the footpath with pedestrian access are identified. A footpath may also provide access to local destinations and does not connect nodes.
- 2.7.5 After deducing the link function, the link significance is derived as shown in **Table 2**. On some occasions when the concerned footpath section is along a major pedestrian corridor, special consideration would be required when determining its link significance.
- 2.7.6 A flow chart summarising the steps to determine the link significance for a section of footpath is given in **Annex D**.

Table 2. Link significance

		Movement level of another node		
		High	Medium	Low
Movement level of a node	High	L3	L2	L2
	Medium	L2	L2	L1
	Low	L2	L1	L1

Remark: Footpath of L1 significance may also provide pedestrian access to local destinations and does not connect nodes.

3. Step 2 - Urban Analysis

3.1 The urban analysis for preparing the OPPs comprises the urban design appraisal of the Planning Area, the delineation of urban grids for placing higher priority for pedestrians in relevant part of the road network, the formulation of the planned pedestrian network, the analysis of the relative priorities for the link and place function of the pedestrian routes on the pedestrian network, and devising pedestrian improvement measures in accordance with their link and place significance. The process of urban analysis generates the Urban Design Plan, Urban Grid Plan, Pedestrian Network Plan, Link and Place Typology Plan and Pedestrian Improvement Plan.

3.2 Urban Design Plan

3.2.1 The Urban Design Plan shows elements for the nodes, precincts and places, the pedestrian movement pattern and their relationships to land use and urban design, providing the planning context for the subsequent OPP planning process. It may co-relate with the urban design concept of the ODP/OZP, the urban design plans/schemes formulated under the urban design study and other relevant studies of the existing built-up area or NDA.

3.2.2 The Urban Design Plan helps delineate the Urban Grid Plan by analysing the urban structure, the spaces for movement by vehicles and pedestrians and pedestrian desire lines. It helps formulate the Pedestrian Network Plan by the nature and pattern of movement identified.

3.3 Urban Grid Plan

3.3.1 The Urban Grid Plan defines major vehicular thoroughfares within the Planning Area. The outer grid

¹ Nodes are places including but not limited to Activity Nodes, Character Streets and Links, Public Space and Transport Nodes.

lines of urban grids are formed by roads that are important links for motorized transport modes and generally with high vehicular demand and of high level of significance in the road network. These are trunk road, primary distributor and district distributor (of the road classification system) and key public transport corridors. Mobility performance of the area are likely sensitive to alterations to these important links at the outer grid lines. The outer grid should primarily be retained to facilitate vehicle movement.

3.3.2 By reviewing Public Transport Route and Road Network Plan (Session 2.5 refers), the outer grids are defined when there is

- carriageway with dual/ single 2-lane or more; or
- a walking radius between 150m to 300m; or
- edge of the Planning Area.

The boundary of the urban grids should also have regard to the existing/ planned functions and characteristics of the neighbourhood.

3.4 Pedestrian Network Plan

3.4.1 A Pedestrian Network Plan shows the planned pedestrian network and the hierarchy of existing and planned pedestrian routes, including Primary Pedestrian Routes, Secondary Pedestrian Routes and Tertiary Pedestrian Routes. It is derived from the Pedestrian Route Plan, the pedestrian planning intention, planning objective and the planned network to achieve the four pillars of walkability for the Planning Area.

3.4.2 Three levels of pedestrian routes are described below:

- Primary Pedestrian Routes: routes provide the most direct, desirable and vital connections between major destinations or transportation nodes. Primary Pedestrian Routes are characterised by high pedestrian demand and pedestrian flow.
- Secondary routes: routes are less in usage, and see less demand than Primary Pedestrian Routes and connect to other destinations.
- Tertiary routes: shortcuts or laneways between buildings, which have the least usage and demand among all pedestrian routes.

3.5 Link and Place Typology Plan

3.5.1 A Link and Place (“L&P”) Typology matrix for Pedestrian Ways classifies the pedestrian ways according to the Link and Place matrix into nine classifications of pedestrian ways in **Figure 2**. Each axis is divided into three level of significance: high, medium and low.

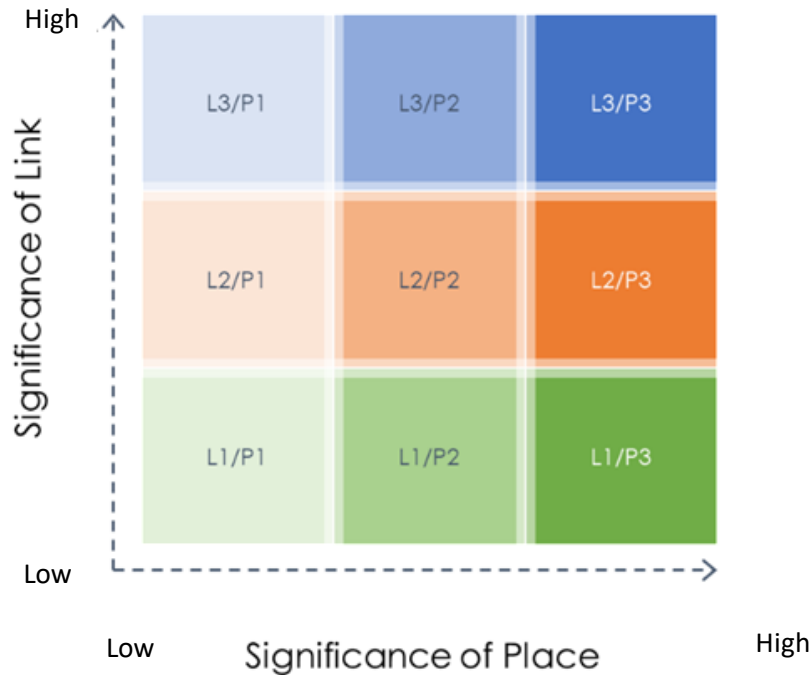
Figure 2: Link and Place Typology Matrix for Pedestrians Ways

- 3.5.2 Each classification in the L&P Typology matrix reflects different functions and respective significance of the link and place in question. The typology approach enables quick understanding of a pedestrian way's role and relative priorities for the link and place functions.
- 3.5.3 A L&P Typology Plan provides an overall picture of the combined place and link significance of the pedestrian routes for the Planning Area with the information of Place Data and Significance Plan and Link Data and Significance Plan.
- 3.5.4 The L&P Typology of a pedestrian way may change with time when there are new developments or planned pedestrian facilities in the area. It may be used as a planning tool to compare and contrast with the existing and the planned pedestrian environments, to identify any gaps or under-performance and to enable appropriate improvement proposals to be readily applied with a view to bringing walkability improvement in the district. Suggested walkability enhancement proposals under the L&P Typology matrix are shown in **TPDM Volume 6 Chapter 10 Section 10.5.3**.
- 3.6 Pedestrian Improvement Plan
- 3.6.1 The Pedestrian Improvement Plan shows all pedestrian improvement measures that have been proposed to enhance the walking environment, as a result of the overall pedestrian planning exercise for a specific OPP area. The Pedestrian Improvement Plan consists of walkability enhancement measures suitably selected under the L&P Typology Matrix. It should be supplemented by detailed design and assessment when appropriate.
- 3.6.2 The recommended footpath width requirements are summarised in **Annex E**. The L&P functions of a pedestrian way and the relative link and place significance of three pedestrian zones of it have been applied to refine the three-zone concept² to help determine the relative space allocated to each zone and the types of pedestrian improvements, reflecting the pedestrian needs in a more comprehensive and balanced manner.
4. **Step 3 – Preparation of the OPPs**

² Table 9, Chapter 8 of HKPSG.

- 4.1 The preparation of the OPPs involves the preparation of Pedestrian Way Zonal Plan supplemented by specific guidance for each category under the L&P Typology and Pedestrian Framework Plan supplemented by explanatory statement setting out the planning context, planning intention, planned pedestrian network and associated pedestrian improvements, together with the key features identified in the urban analysis to govern the design and implementation.
- 4.2 Pedestrian Way Zonal Plan
- 4.2.1 The Pedestrian Way Zonal Plan (“PWZP”) provides general guidance for pedestrian zones (including space reservation, pedestrian facilities, design, management and up keeping guidelines) for different categories of pedestrian ways corresponding to their relative link and place priorities under the Link and Place Typology matrix. In general, one typical profile of the pedestrian zones should be prepared for each category in the typology matrix, and therefore at least nine profiles should be drawn up for the PWZP.
- 4.2.2 The PWZP covers the pedestrian routes at grade, and where applicable, above-grade and below-grade for the nine categories of pedestrian ways under the Link and Place Typology matrix.
- 4.2.3 The PWZP delineates the pedestrian ways into zones, together with a set of notes to guide the implementation in the longer term for the design, management and up keeping of the pedestrian realm and pedestrian improvements.
- 4.2.4 Following the three-zone concept as set out in **Annex E**, there are different emphasis on link and place functions in the Through Zone, Building Frontage Zone and the Street Furniture and Greening Zone. For the Through Zone, the emphasis is on improving the link function. Thus, a minimum footpath width of 3.0 m to 4.5m for the Through Zone for all land uses except rural uses is proposed, and the LOS target is LOS C or above. For the Building Frontage Zone and the Street Furniture and Greening Zone, the emphasis is on the place function, and the footpath width standard for these zones corresponding to the place significance of these zones is proposed. These footpath standards and other guidance on pedestrian facilities, design, management and up-keeping of the pedestrian realm (such as building set back to increase footpath width, building canopies to improve weather protection, space allocation, waiting facilities for buses, and other typical pedestrian improvement measures for the pedestrian ways should be manifested in the typical profiles for different categories of pedestrian ways under the Link and Place Typology matrix.
- 4.2.5 The PWZP, together with a set of notes, guides the implementation of the walkability enhancement measures for that typology. The notes are to explain the space allocation to accommodate varying pedestrian functions and activities corresponding to the Link and Place Typology, as well as to support the deployment of various tools in prioritising the pedestrian needs in relation to the link and place functions.
- 4.2.6 The PWZP is to be read in conjunction with the PFP to provide a complete OPP for a Planning Area. The latter shows the spatial locations of the pedestrian improvements in the Planning Area.
- 4.3 Pedestrian Framework Plan
- 4.3.1 The PFP sets out the strategic, high-level vision for the proposed OPPs. The PFP is accompanied by a set of explanatory statement that sets out the planning objectives and planning intentions for each of the main improvement areas. The strategic connections and planning intentions set out in the PFP are translated into location-specific interventions from the Pedestrian Improvement Plan. The PFP shows mainly the urban grid for mobility, the planned pedestrian network with the pedestrian routes, and the pedestrian improvement measures corresponding to the Link and Place Typology and other relevant considerations.
- 4.3.2 The explanatory statement accompanying the PFP is to set out the pedestrian planning and pedestrian improvement proposals in context, which comprises the following key components:

- **Introduction and Background** – Introduce the basic characteristics of the Planning Area (i.e. the existing built-up area or NDA), as well as the objectives of the OPPs.
- **Planning Vision** – Address the challenges, opportunities and pedestrian planning issues in respect of the four pillars of walkability and particular to the Planning Area (i.e. the existing built-up area or NDA) for setting out the pedestrian planning intentions of the OPPs.
- **Pedestrian Design and Landscape Concepts** – Identify the pedestrian design and landscape design concepts, specifically tailored to the Planning Area, which will inform the pedestrian planning proposals.
- **Challenges and Opportunities** – Set out the major pedestrian planning issues and trends in the Planning Area.
- **Pedestrian Planning Intention and Objectives** – Recap the guiding vision and planning objectives of the overall walkability strategy of Hong Kong and its specific application to the Planning Area.
- **Application of new Pedestrian Planning Approach and Design Standards** – Highlight urban grids, planned pedestrian network, pedestrian improvement measures available, with particular regard to the link and place typologies, and the application of new standards for footpath width and other pedestrian planning and design standards.
- **Key Walkability Enhancement Areas** – Define key walkability enhancement areas, which are identified and delineated to cover an urban grid or a group of urban grids according to their functions, special characteristics and walking conditions, around which the pedestrian enhancement measures are structured. The nature of the walking enhancement measures should respond to the unique challenges of the key enhancement areas.
- **Implementation** – Set out the implementation time frame and packages as appropriate for the walkability enhancement measures.

4.3.3 Technical assessments, in terms of traffic review/ TIA, constructability, time and cost implications, shall be conducted where necessary before the implementation of the walkability measures.

Annex A**Place Significance Table**

Defining Place Significance

(A) Catchment size for nodes of different land use types

Land Use⁽¹⁾	Catchment Size⁽²⁾
<ul style="list-style-type: none"> • Arts Venues (for territorial use) • Commercial (Exhibition/ Convention Hall) • Commercial (Offices) • Elevated Walkway to Access of Railway Station • Higher Education • Open Space (for regional use)⁽³⁾ • Railway Station • Sports Ground • Stadium • Water Recreation Centre 	Territorial
<ul style="list-style-type: none"> • Clinics/ Health Centres • Commercial (Market) • Commercial (Hotel (4 stars or above)) • Commercial (Shopping Malls) • Commercial (Street-front Shops) • Commercial (without shop frontage) • Commercial/ Residential Zone • Hospitals/ Specialist Clinics/ Polyclinics • Indoor Recreation Centre • Libraries • Open Space (for district use)⁽³⁾ • Public Transport Interchange • Religious Institution • Secondary Schools • Social Welfare Facilities 	District

<ul style="list-style-type: none"> • Sports Centre • Swimming Pool 	
<ul style="list-style-type: none"> • Arts Venues (for local use) • Commercial (Eating Place) • Commercial (Shopping Malls (for local use)) • Commercial (Street-front Shops (for local use)) • Community Halls • Kindergartens • Open Space (for local use) ⁽³⁾ • Primary Schools • Residential Zone 1 	Local

Remarks:

- (1) The “link and place” approach provides a framework that takes into consideration land use and activities. In terms of land use, reference should be made to the Outline Zoning Plan / Outline Development Plan / other related sources of the NDA/existing built-up area concerned to identify relevant land uses and facilitate defining their place significance. The land uses shown are not exhaustive. For land uses not included, the catchment size should be reviewed and determined in light of envisaged situations.
- (2) Reference is made from Table 4, Chapter 3 of HKPSG for the community facilities related land use while the assumed catchment sizes for other land uses follow general planning practice.
- (3) Reference from definitions in Chapter 4 of HKPSG.

(B) Level of Vibrancy for nodes of different land use types

Land Use ⁽¹⁾	Level of Vibrancy
<ul style="list-style-type: none"> • Arts Venues (for territorial use) • Commercial (Exhibition/ Convention Hall) • Commercial (Hotel (4 stars or above)) • Commercial (Shopping Malls) • Commercial (Street-front Shops) • Elevated Walkway to Access of Railway Station • Higher Education • Open Space (for regional use) • Railway Station • Sports Ground • Stadium • Water Recreation Centre 	High
<ul style="list-style-type: none"> • Arts Venues (for local use) • Hospitals/ Specialist Clinics/ Polyclinics • Clinics/ Health Centres • Commercial (Eating Place) • Commercial (Market) • Commercial (Office) • Commercial (Shopping Malls (for local use)) • Commercial (Street-front Shops (for local use)) • Commercial/ Residential Zone • Community Halls • Indoor Recreation Centre • Kindergartens • Libraries • Open Space (for district use) • Primary Schools • Public Transport Interchange 	Medium

<ul style="list-style-type: none"> • Religious Institution • Secondary Schools • Social Welfare Facilities • Sports Centre • Swimming Pool 	
<ul style="list-style-type: none"> • Commercial (without shop frontage) • Open Space (for local use) • Residential Zone 1 	Low

Remarks:

- (1) The “link and place” approach provides a framework that takes into consideration land use and activities. In terms of land use, reference should be made to the Outline Zoning Plan / Outline Development Plan / other related sources of the NDA/existing built-up area concerned to identify relevant land uses and facilitate defining their place significance. The land uses shown are not exhaustive. For land uses not included, the level of vibrancy should be reviewed and determined in light of envisaged situations.

Annex B

Flow Chart: Steps to Determine the Place Significance for a Section of Footpath

Remark

[1] Nodes are places including but not limited to Activity Nodes, Character Streets and Links, Public Space and Transport Nodes.

[2] In case there are more than one node along the footpath, determine the “catchment size” and “level of vibrancy” based on the most representative level of these nodes.

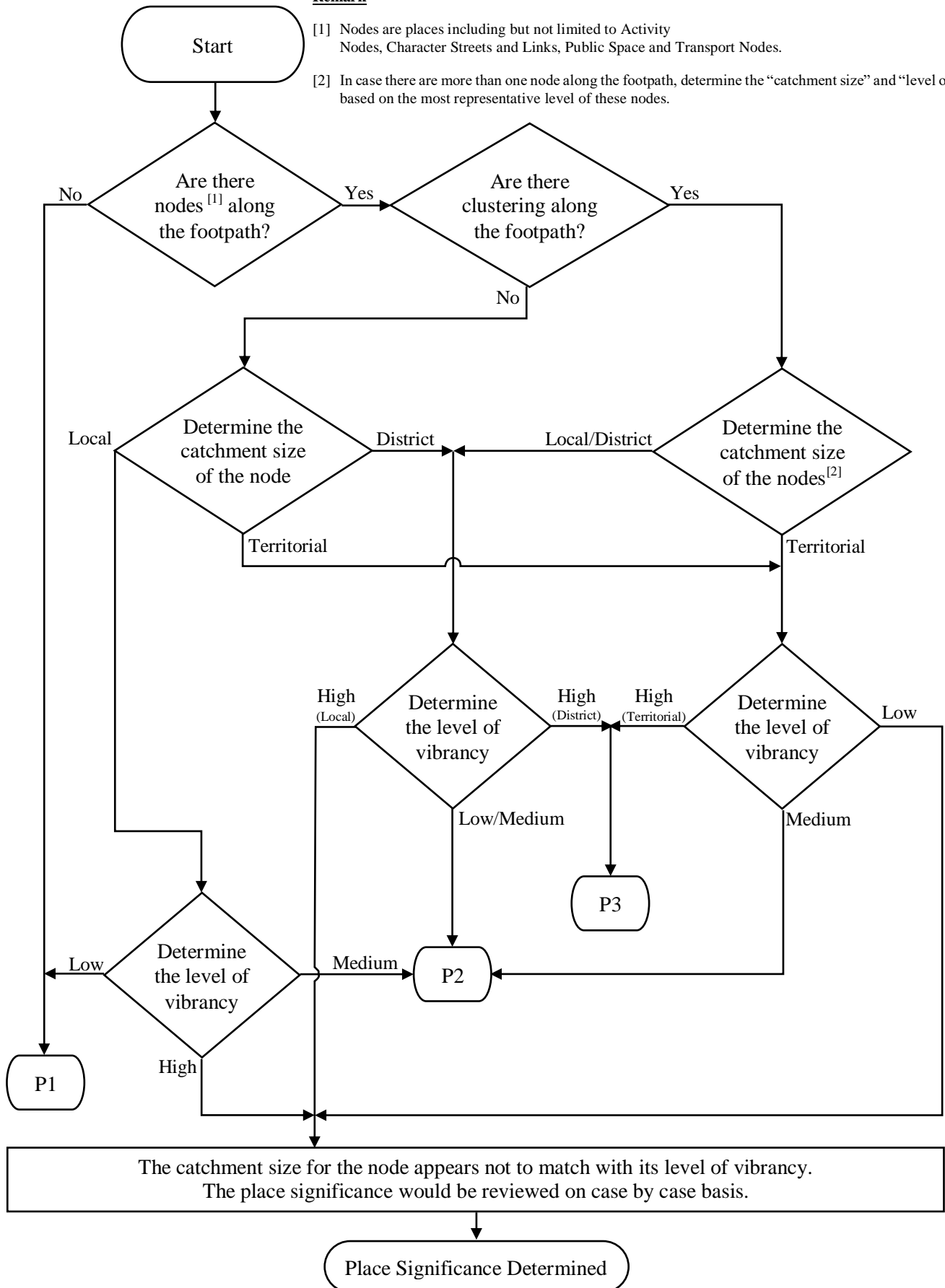

Annex C

Link Significance Table

The movement level for nodes of different land use types

Land Use ⁽¹⁾	Movement Level
<ul style="list-style-type: none"> • Art Venues (for territorial use) • Commercial (Exhibition/ Convention Hall) • Commercial (Shopping Malls) • Commercial/ Residential Zone • Elevated Walkway to Access of Railway Station • Higher Education • Commercial (Hotel (4 stars or above)) • Open Space (for regional use) • Open Space (for district use) • Public Transport Interchange • Railway Station • Residential Zone 1 • Sports Ground • Stadium • Water Recreation Centre 	High
<ul style="list-style-type: none"> • Art Venues (for local use) • Commercial (Eating Place) • Commercial (Market) • Commercial (Office) • Commercial (Shopping Malls (for local use)) • Commercial (Street-front Shops) • Commercial (without shop frontage) • Community Halls • Clinics/ Health Centres • Hospitals/ Specialist Clinics/ Polyclinics • Indoor Recreation Centre • Libraries • Open Space (for local use) • Primary Schools • Religious Institution • Secondary Schools • Social Welfare Facilities • Sports Centre • Swimming Pool 	Medium
<ul style="list-style-type: none"> • Commercial (Street-front Shops (for local use)) • Kindergartens 	Low

Remarks:

- (1) The “link and place” approach provides a framework that takes into consideration land use and activities. In terms of land use, reference should be made to the Outline Zoning Plan / Outline Development Plan / other related sources of the NDA/existing built-up area concerned to identify relevant land uses and facilitate defining the link significance. The land uses shown are not exhaustive. For land uses not included, the movement level should be reviewed and determined in light of envisaged situations.

Annex D

Flow Chart: Steps to Determine the Link Significance for a Section of Footpath

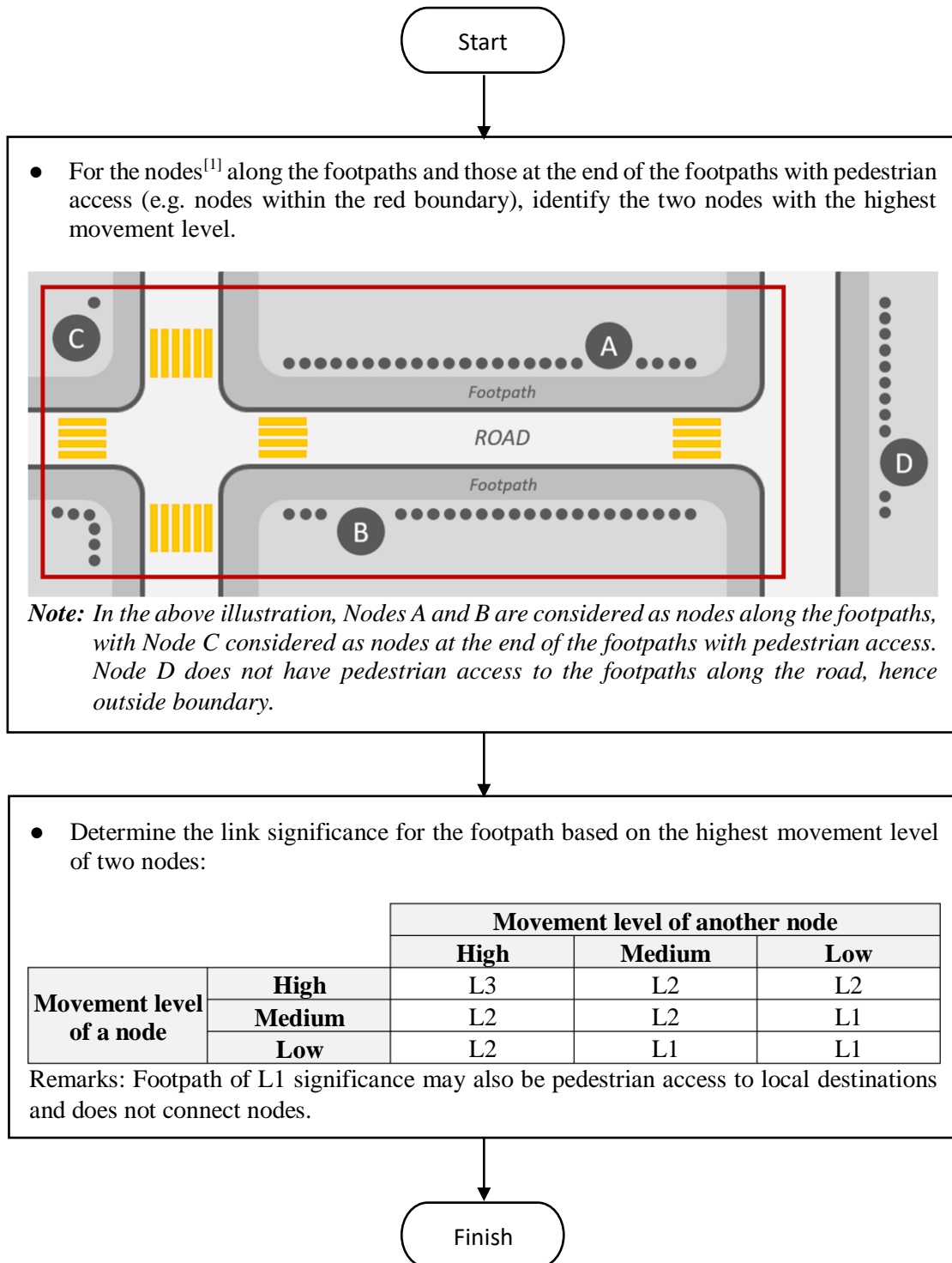

Remarks

[1] Nodes are places including but not limited to Activity Nodes, Character Streets and Links, Public Space and Transport Nodes.

Annex E

New Minimum Footway Width Requirement

Land Use Type	Through Zone Width ^{[1][3]/} Peak Pedestrian Volume	Building Frontage Zone Width ^[3]	Street Furniture and Greening Zone Width ^{[2][3]}
Commercial Commercial / Residential Residential Zone 1 and those other areas near pedestrian generators such as cinemas, rail stations, some GIC facilities (e.g. schools), etc.	Link 4.5 m ^[4] Very High	Place 0.5 m (P1) <i>Extra-over allowance for higher place significance</i>	Place 1.5m (P1) <i>Extra-over allowance for higher place significance</i>
Residential Zone 1	3.5 m ^[4] High		
Residential Zone 2	3 m ^[5] Medium		
Residential Zone 3	3 m ^[5] Low to Medium		
Rural	2 m ^[4] Very Low	1.0m (P2)	2.0m (P2)
Business	4.5 m ^[4] Medium	1.0m (P3)	3.0m (P3)
General Industrial Use	4.5 m ^[4] Medium		
Special Industrial Use	3.5 m ^[4] Low to Medium		
Rural-Based Industrial Use	2.5 m ^[4] Low		

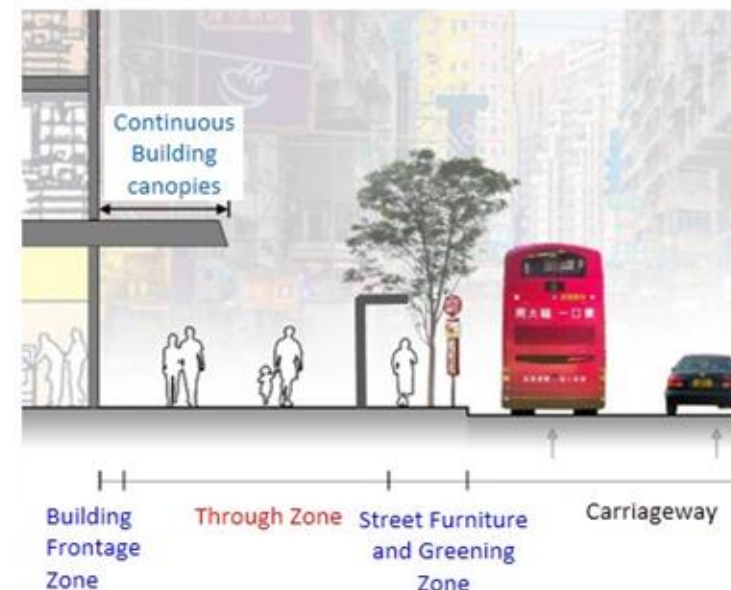

Remarks:

- [1] Designed to achieve Level-of-Service (LOS) C or above (*LOS C = 23-33 pedestrians/minute/metre*)
- [2] If planting is provided, the zone shall have a minimum width as shown in the table. The designer shall also refer to the notes of Table 9 of Chapter 8 of the HKPSG regarding the increase in width for planting of large trees, installation of bus shelters and large street furniture, etc. Tree planting and greening works shall follow the spatial requirements as stipulated in DEVB TC(W)No. 2/2012.
- [3] Minimum footpath clear width of 3m should be provided if the total three-zone width could not be achieved. The minimum footpath width is to tie in with the increase in pedestrian volume due to increase in residential development intensities under the HKPSG in recent years, to cater for needs of the ageing population, the physically

disadvantaged and other vulnerable pedestrian groups, and to provide for a more comfortable pedestrian environment under more frequent inclement weather events due to climate change.

[4] Reference is made to HKPSG Chapter 8 Table 9 for the Through Zone width.

[5] The increase in footpath width to 3m for both Residential Zones 2 and 3 is to tie in with the increase in pedestrian volume due to increase in residential development intensities under the HKPSG in recent years and to enhance the LOS to a level of C or above for all urban land use zones.

10.5 Design of Pedestrian Improvement Measures

10.5.1 Data Collection and Review of Existing Conditions

- 10.5.1.1 Surveys can reveal the existing transport facilities and the existing pedestrian and vehicular flows in the subject area. Observation techniques such as screen line and cordon count may provide sufficient information on the traffic flows, pedestrian movements and inventories of transport facilities. Other survey techniques such as written methods using questionnaires/travel diaries, and oral approach of face-to-face and telephone interviews will provide higher resolution of the travel patterns with respect to the purposes, origin-destination, travel time, mode share, trip proportion.
- 10.5.1.2 The transport facilities inventory provides information about the facilities in the existing pedestrian and vehicular networks. The surveys are on-site observation and records of all existing transport facilities in the study area. In general, the inventory includes general road layout, pedestrian facilities, on-street and off-street parking facilities, on-street loading provisions, and stopping restrictions.
- 10.5.1.3 The general road layout contains description of major highway corridors in the study area with respect to the road hierarchy, characteristics, access points, implemented traffic management schemes such as bus-only lane, priority movements, one-way streets etc. A plan is suggested showing the road network and the study area.
- 10.5.1.4 There should be a comprehensive description of the pedestrian network and facilities such as existing principal pedestrian corridors, walkway systems, at-grade and grade separated crossings, and existing pedestrian priority/traffic calming areas etc. The pedestrian facilities should also include those within private developments, which form part of the pedestrian network.
- 10.5.1.5 This includes the on-street and off-street parking provision, private and public car parks for various types of vehicle (cars, goods vehicles, coaches, motorcycles, special vehicles etc.) and their utilization. Stopping restrictions for different types of vehicles (all traffic, minibuses, goods vehicle etc.) and the hours of the restrictions should be described. The demand for loading/unloading should be assessed. A plan is recommended to show the locations, numbers and type of space, and also locations and access points for loading/unloading, within the study area.
- 10.5.1.6 The public transport service inventory contains information of the existing services and details of their operation. The inventory includes services of franchised bus, Red Minibus (RMB), Green Minibus (GMB), Taxi, Tram and Residents Services.
- 10.5.1.7 The surveys collect information on termini locations, stopping points (both regulated and popular pick up and drop off points), number of routes, popular routings of the services, peak frequencies of services, passenger queuing and any other operation characteristics of public transport of railways, bus, minibuses, trams, taxi, resident services, ferries, etc.
- 10.5.1.8 Screen line surveys at selected location can further collect information of routing, frequency of services and occupancy details.
- 10.5.1.9 The pedestrian and vehicular surveys can establish the levels of demands on existing facilities and to determine the requirement for, and to forecast the impacts of other schemes.

- 10.5.1.10 The collected information forms the platform for the pedestrian environment improvement schemes. The peak periods can be identified by full day pilot surveys at key locations. Where appropriate the pilot surveys may include counts on weekdays, Saturdays, Sundays and Public Holidays. Comprehensive surveys of the pedestrian and vehicle movements can be undertaken for the identified peak periods over the study areas. It may also refer to data of other recent studies in the same areas or from other reliable sources.
- 10.5.1.11 The pilot pedestrian surveys may be conducted between 0700 and 1930 hours in general. The period would be site specific. The pilot pedestrian flow data are plotted along the time scale so that the variation of pedestrian flow suggests the peak periods. In some situations, the variation is so small that no peak flow is identified.
- 10.5.1.12 A comprehensive pedestrian survey can be conducted over the study area for the identified peak periods. The flow data may be tabulated with details of their station reference, sidewalk or cross walk type, location, flow at each side, total flows, average LOS and LOS at pinch point. The pinch point LOS assesses the worst service level because of local bottleneck caused by walkway obstruction objects.
- 10.5.1.13 The pedestrian peak flows are usually expressed in 15-minutes interval. A plan is suggested showing the observed peak flows at each sides of the corridors. For comparison, the flow data can be converted to Level-of-Service (LOS). A brief summary of LOS is given in section 10.5.2.2 (viii).
- 10.5.1.14 The pilot vehicle surveys should be classified counts of typical traffic composition of car/motorcycle, minibus, taxis, LGV, MGV, HGV, bus/coach, tram etc. Turning movements at junctions are to be included in the surveys. The peak hourly link flow, expressed in pcu, may be presented on a plan. The pcu values of different vehicle types could be found from TPDM Volume 2 Chapter 2.
- 10.5.1.15 Comprehensive vehicle traffic surveys can be conducted over the study area for the identified peak periods. The vehicular traffic flow data can be tabulated with reference to the traffic composition, the number of vehicle, proportion/percentage, equivalent pcu, and the totals at each link.
- 10.5.1.16 Scenarios with combinations of the heaviest demands of both pedestrian and vehicular movements may be further considered for improvement schemes. The incidences may not coincide. The peaks of vehicle traffic and pedestrian movement will be site and time specific.

10.5.1.17

In order to decide which parts of a pedestrian network require improvements, the designer needs to have a clear understanding of the patterns of pedestrian activities. However, pedestrians, unlike vehicles, do not confine themselves to specific routes but rather follow the shortest and most direct path between the origin and destination. Surveys can be undertaken by a variety of techniques, using interviews, filming and observations. Generally, a combination of survey techniques should be used so as to cross-validate data.

(a) Principal Pedestrian Corridors

The busy pedestrian corridors can be identified with site observation, pedestrian counts, and traffic information at the subject area. The principal pedestrian origin-destination desire routes can be established with reference to the principal attraction/generation of walking trips, and pedestrian facilities within the area. On-site observation, shadowing pedestrians and identifying trip purposes are additional information confirming the pedestrian travel patterns.

(b) Pedestrian Accident Situation

A statistics of accident involving pedestrians for up to the last three years in locations within the study areas may be required to tell how serious the conflicts between pedestrians and vehicles have been.

(c) Air Pollution Black Spots

The information of locations with levels of roadside pollution can be obtained from the Environmental Protection Department.

(d) Sensitive Receivers

Sensitive receivers such as schools, churches, parks and hospitals need careful consideration of impacts such as noise, air pollution and travel patterns of pedestrian and vehicular movements. Some frontage shops requiring frequent roadside access/loading/unloading such as garages, builders' shops, and hardware shops need due consideration of their loading operations.

(e) Vehicular Right-of-Way

The right-of-way of access for loading/unloading within buildings and for both public and private car parks should be properly addressed. Entry control by means of permits can be one of the ways to introduce pedestrianisation at streets with light vehicular access.

10.5.2**Planning for Pedestrian Improvement Measures**

10.5.2.1

This section considers improvements that will benefit the pedestrian environment and takes account of the distinct sense of place and avoid being monotonous to enhance the vitality. Schemes for pedestrian improvement measures may be developed beyond the streets and link/extend to open space, laneways and squares.

10.5.2.2

The following highlights some salient points for consideration while carrying out planning for pedestrian improvement measures:

- (i) According to the link and place functions of pedestrian ways as mentioned in Section 10.4.4.2 (ii) under this chapter, full-time and/or part-time pedestrianisation at streets with “high” place function could be considered. Pedestrianisation should not be taken easily since it would likely cause nuisances to the neighbourhood and attract public criticism. An alternative is to introduce traffic volume and speed reduction measures to deter non-essential vehicular traffic and calm down traffic volume and speeds.
- (ii) Following the reduction of vehicular traffic, street space can be re-orientated with priorities allocated towards pedestrians to satisfy their genuine needs and the intended functions of the streets.
- (iii) In order to provide proper and safe facilities for pedestrians within the pedestrian priority/traffic calming areas, slight delay to vehicular traffic may have to be accepted though the extent to which this may affect public transport and the movement of emergency vehicles will need to be taken into account.
- (iv) The objective of the urban grid for mobility as mentioned in Section 10.4.4.2 (i) under this chapter is intended to deter non-essential traffic from entering the inner grids to accord higher priority to pedestrian.
- (v) One of the objectives in the reallocation of street space is to discourage on-street parking. For the time being, on-street parking for motorcycles is maintained. The possibility of having motorcycles parked at off-street carparks should be explored. Designated on-street parking space for people with disabilities are necessary for their accessibility. Parking space for coaches may be necessary at tourist attraction sites.
- (vi) It may be necessary to reroute public transport (bus, GMB, taxi, etc.) services away from the critical pedestrian priority/traffic calming areas. Special consideration should be given to whether or not to exclude public transport, so as to ensure continued ease of access to the streets and to the buildings. Impacts on the commuters should be considered and provision of comfortable and safe linkages between the new stopping places and the activities centers are necessary. The diverted route should possess sufficient link and junction capacities, and space for public transport stops along the new routes.

(vii) Loading/unloading Bays

- (a) The provision of laybys for loading/unloading of goods, and dropping off/picking up of passengers need to be carefully reviewed, especially near areas which are to be full-time or part-time pedestrianised although loading operation may be carried out outside the pedestrianisation hours at part-time pedestrian streets.
- (b) Latent demands may arise from the removal of previous on-street parking space, pedestrianisation, street activities, and change of travel pattern in the vicinity.
- (c) The width of layby depends on site conditions. A width of 3.0~3.5m is recommended for laybys with frequent heavy goods vehicle loading operation and/or coaches/large buses. Laybys of 2.5m wide are often sufficient to serve private cars, LGVs, taxis and minibuses.
- (d) The loading/unloading provisions should be reviewed together with the kerbside no stopping restrictions regularly.

(viii) Footpaths width assessments

- (a) The width of footpaths should be able to cope with the expected future pedestrian volume and take into consideration of the link and place functions of the footpaths. For general guidance, refers to TPDM Volume 2 Section 3.4.11, regarding the minimum width of footways. Footpaths should accommodate the peak uses. Latent demands may arise following improvements of the street environments, provision of new footways, change of travel patterns, and possible land use changes etc.
- (b) Providing adequate width of footpath and allowing a zone for amenities such as street trees, seating, bus shelters are important to enable pedestrians to walk with comfort and safety. If these facilities cannot be provided during the construction stage, adequate space should be reserved for incorporation at a later stage.
- (c) An alternative to assess the width of footpath in the Through Zone for pedestrian movements is the Level-of-Service (LOS) in the Highway Capacity Manual (HCM-version 2000). The HCM LOS is primarily based on the density of people in a given space and has six levels. In general, LOS C is desirable for most design at streets with dominant 'living' pedestrian activities. Extracted details of the HCM LOS are tabulated below. The flow rates may need adjustments accounting for critical clear width of footpaths and conflicting factors for reverse and crossing movements in the main stream of the subject area.

Description of Level-of-Service (LOS)
(Reference: HCM 2000)

LOS	Flow Rate (ped/min/m)	Description
A	≤ 16	Pedestrians basically move in desired paths without altering their movements in response to other pedestrians. Walking speeds are freely selected, and conflicts between pedestrians are unlikely.
B	16 - 23	Sufficient space is provided for pedestrians to freely select their walking speeds, to bypass other pedestrians and to avoid crossing conflicts with others. At this level, pedestrians begin to be aware of other pedestrians and to respond to their presence in the selection of walking paths.
C	23 - 33	Sufficient space is available to select normal walking speeds and to bypass other pedestrians primarily in unidirectional stream. Where reverse direction or crossing movement exist, minor conflicts will occur, and speed and volume will be somewhat lower.
D	33 - 49	Freedom to select individual walking speeds and bypass other pedestrians is restricted. Where crossing or reverse-flow movements exist, the probability of conflicts is high and its avoidance requires changes of speeds and position. The LOS provides reasonable fluid flow; however considerable friction and interactions between pedestrians are likely to occur.
E	49 - 75	Virtually, all pedestrians would have their normal walking speeds restricted. At the lower range of this LOS, forward movement is possible only by shuffling. Space is insufficient to pass over slower pedestrians. Cross- and reverse-movement are possible only with extreme difficulties. Design volumes approach the limit of walking capacity with resulting stoppages and interruptions to flow.
F	> 75	Walking speeds are severely restricted. Forward progress is made only by shuffling. There are frequent and unavoidable conflicts with other pedestrians. Cross- and reverse-movements are virtually impossible. Flow is sporadic and unstable. Space is more characteristics of queued pedestrians than of moving pedestrian streams.

(ix) Street furnitures

- (a) Bus stops, bus stop shelters, taxi stands, minibus stands, resident services (RS) stops and other associated on-street facilities should be critically reviewed and rationalized as necessary for better pedestrian environment.
- (b) Other street furniture such as railings, post boxes, fire hydrants, traffic signs, direction signs, advertisement displays, roadside cash machines, telephone kiosks, litter bins, planters, passenger shelters, queue railings and the likes also reduce the clear width and interrupt the pedestrian movements and obscure pedestrian sightlines (particularly at crossings and corners). They should be reviewed and rationalized while the streetscape is being enhanced.

- (c) The street furniture being the responsibility of several organizations including utility companies may not be well coordinated to the best interest of pedestrians, particularly to people with visual impairments. These organizations need to work together to get rid of superfluous obstacles. What is left should be useful, attractive and in the right place. The facilities should take account of the needs of people with disabilities. TPDM Volume 6 Chapter 8 has more details.
- (x) Landscape works such as planting, seating, and sheltering should be considered in the early planning stage, so long as the minimum clear width of footpath can be provided. Street trees provide air purification benefits, greenery for more appealing environment for pedestrian, and shade against strong sunlight and limited protection against rain.
- (xi) At-grade crossings
 - (a) The existing pedestrian crossing facilities need regular reviews to reflect the possible increase in pedestrian volumes at signal junctions. At-grade crossings are ranked top for the convenience to pedestrians. Where possible, cautionary crossings and zebra crossings should be upgraded to signal crossings whereas staggered crossings should be converted to straight crossings. Demand dependent (push button) type would be suitable for locations, at which the pedestrian crossing demand is light but genuinely needed. Red light camera (RLC) helps enforcement of red light jumping especially at signal crossings with light and infrequent pedestrian crossing demands. RLC should be installed on road safety grounds irrespective of the pedestrian flows.
 - (b) Review the locations of crossings at which people want to cross as far as practicable. The crossings should be free of any obstruction such as controller, traffic signs, fire hydrants etc. The demand for crossing locations may change over time.
 - (c) At signal-control junctions, the pedestrian waiting timing can be shortened, the crossing time can be lengthened and pedestrians can complete the crossings with minimum number of stages. Direct single crossings are preferable to staggered crossings. The size of refuge islands and the waiting areas at crossings should be adequate to accommodate waiting pedestrians. At wide junctions with heavy pedestrian crossing demands, diagonal crossings may be considered even at the expense of longer delay to vehicle traffic.
 - (d) New at-grade crossings may be planned to cope with the increased demands following new travel patterns arising from changes in land use or new transport infrastructure/policies.
- (xii) Grade-separated crossings

- (a) In densely populated residential or commercial areas, grade-separated walkway systems can link up developments and public transport nodes so as to provide a safe and convenient passageway for pedestrians. Provisions should include ramps, lifts, travelators especially for long walkways with heavy pedestrian flows. It may be worthwhile to explore options of air-conditioned walkway systems and underground streets, which will provide full weather protection and comfortable walking environment. The feasibility would depend on the availability of space and access to the developments. Some walkway systems may connect to shopping malls, which are closed at night. Alternative should be made available nearby in particular for crossings over major distributor roads.
 - (b) New footbridges/subways are necessary to cope with new demands or to augment the limiting capacity of existing facilities. As construction takes a few years for completion, it may be considered as a (long) medium term proposal. However, when planning new developments on reclamation or elsewhere the provision of walkway systems should be considered.
 - (c) A 24-hour unrestricted access and/or passage within new development or redevelopment can improve pedestrian circulation. The provision of connection points and right-of-way for pedestrian access and passage may be included in the Lease of the development or redevelopment. The walkways can be at-grade or grade-separated. In the latter case, it should also be linked to at-grade public walkways, footbridges, and/or other walkways systems with 24 hours access and pedestrian passage rights.
 - (d) Provision of one lift on each side of a footbridge for people with disabilities within the development with 24 hours unrestricted access may be considered as a suitable replacement for ramp. However, if such facility can be provided on one side only, appropriate warning signs should be displayed for such information.
 - (e) An integrated walkway system which avoids frequent change of levels should be encouraged.
 - (f) Provided that lands matters can be resolved, provision of shops alongside long walkway (footbridges or subways) may be desirable to attract more people to use the walkway systems. The operation of the shops and activities at display windows should not obstruct the pedestrian movements along the walkways.
 - (g) Natural sunlight penetration to subways, protection from inclement weather and strong sunlight for walkways and footbridges should be considered for the comfort of pedestrians. Surveillance measures such as policing/patrolling, CCTV/video recording, adequate lighting etc. may also be considered. It should be borne in mind that excessive lighting could be unpopular and intrusive to residents nearby.
 - (h) Footbridge is better than subway because of personal security, ventilation, lighting and risk of flooding. Overall, at grade crossings often rank top preference.
- (xiii) Traffic management measures
- (a) Certain traffic management schemes can enhance pedestrian facilities. For example, stopping restrictions can prevent loading vehicles from impeding the smooth flow of traffic, and also stop vehicles from blocking

pedestrian crossings hence improve pedestrian sight lines. One-way routing would simplify turning movements at junctions and enable new or modified at-grade crossings to be provided at signal junctions. Banning of certain vehicular movements or vehicle types reduces the volume and speeds of traffic and enhances pedestrian safety. Traffic calming measures help discourage non-essential and through traffic from entering the traffic calming areas. So long as traffic is manageable, the extra carriageway space may be released for footpath widening.

- (b) Illegal parking on footpath impedes pedestrian movements and damage the pavement. This can be prevented by physical barriers. The provision of adequate and properly located facilities for the parking, loading and unloading of vehicles should be reviewed.
- (xiv) Needs for people with disabilities
- (a) Due consideration should be given to maintain the accessibility of people with disabilities to the pedestrian priority/traffic calming areas. These include facilities such as drop kerbs, tactile guide paths, tactile warning strips, audible signals, ramps, lifts, drop off points, and parking space etc.
 - (b) Clear demarcation in terms of colour, texture and materials are necessary between the driveway and footpath, especially at shared surface streets. High contrast colours should be used whenever possible for the benefit of the visually impaired people.
 - (c) Audible signals are generally provided to assist visually impaired people at signalized pedestrian crossings. The unit, located in the pedestrian push-button box, produces a series of bleeps when activated. It works well at crossings of single carriageways. However, it should be used with caution at locations where another crossing is nearby or on a staggered crossing of a dual-carriageway. There may be confusion about which crossing has been activated. The volume should be automatically adjusted to the ambient background noise level, so as to be heard by pedestrians close to the loudspeaker but not by anyone waiting at the other crossing. The audible signal operates while the steady green-man pedestrian signal is lit.
 - (d) Maintenance works should be undertaken with particular regard to people with disabilities. Special care should be taken wherever maintenance works interfere with facilities provided for such people. Facilities provided for people with disabilities, such as tactile surfaces, are to be reinstated in full after street works have been undertaken.
 - (e) Further advice can be obtained from TPDM Volume 6 Chapter 8- facilities for people with disabilities.
- (xv) Generally speaking, it would be hazardous to allow vehicles entering a full-time or part-time pedestrian area when it is closed to motorised traffic. Access for emergency vehicles is always allowed. Police and FSD should be consulted at the early planning and implementation stages.
- (xvi) The peripheral of pedestrian priority/traffic calming areas should be readily accessible by the public using public transport. Stands for taxis, minibuses, bus stops, tram stops, rail stations etc. should be adequately linked to the activity nodes, usually within the pedestrians/commuters catchments zones.

- (xvii) Due consideration should be given to improvements of the environment of pedestrian streets. The elements include (decorative) lighting, street maps, signing, paving, public toilets, information kiosks, public telephone, rest areas, seating, litter bins, sculpture, fountains and trees. These need to be planned and installed in a coherent way. Proper control of vendors' activities, illegal occupation of footpaths, littering, graffiti and vandalism is needed.
- (xviii) Planning of pedestrian network and land use planning
 - (a) Transport and land use policies interact. Walking cannot be considered in isolation from public transport, cycling or private motoring, or from wider context of land use planning.
 - (b) The main role of land use planning measures is to improve the integration of land use and transportation planning, particularly by reducing the need to travel both in terms of shorter journeys and less frequent travel. Some key aims of land use and transportation planning are to reduce growth in the length and number of motorised journeys, and to encourage alternatives of travel (walking, cycling, public transport etc.) which have less environmental impact. TPDM concentrates on the transport issues. Chapter 8 of the Hong Kong Planning Standards and Guidelines (HKPSG) contains more details on the land use planning.
 - (c) In the short run (usually less than 5 years), land use has predominant influence in the transport system. In the long terms (5 to 10 years), the predominant effects are those of transport infrastructure on urban forms because of improved accessibility.
 - (d) The role of land-use planning in encouraging walking should be strengthened. Walking access to, through and within new developments/comprehensive redevelopments should be a key consideration in planning decisions. Accessibility criteria should apply to the existing urban forms, project locations, whether roads or other barriers prevent walking, whether public passageways or pedestrians' rights of way through the development/redevelopment are provided around the clock and whether the design of the development/ redevelopment promotes an attractive and accessible walking environment. The developers should be encouraged to create an environment that is safe, attractive and interesting for people walking past.
 - (e) Priority should be given to considering pedestrian networks and pedestrian streets in the formulation of transport system in new development areas during the early stage of land use planning and development so that these systems would form an integral part of the development instead of piecemeal facilities. Applying the concept of urban grid for mobility and the link and place approach for pedestrian ways under the PPF as mentioned in section 10.4.4.2 for pedestrian planning and design could help take forward the pedestrian improvement measures in a more holistic and coordinated manner.

- (f) Designation of pedestrian priority areas can give pedestrians priority treatment in the use of street space and facilities within the area. Main features include no carpark building (existing carpark must be removed upon redevelopment of the site); loading and unloading facilities are provided but the routing and periods of operation may be restricted; and roads within the areas are to be local roads with traffic calming measures. Furthermore, incentives such as bonus plot ratio may be considered to encourage developers to set back lot boundaries giving more space for pedestrians on the public streets. PTIs and off-street car parks, with good linkages such as travelators to the pedestrian activities nodes, should be considered at the peripheral of the designated pedestrian priority/traffic calming areas.
- (g) In the planning of large housing estates, consideration should be given to place PTI at the peripheral of the estates so that buses and other vehicles would not be required to enter the housing estates and thus reduce pollution and nuisance to the residents. Travelators should then be considered as necessary to provide a means of mechanical linkage between the PTI and individual housing blocks and others nodes.
- (h) Facilities should aim to make pedestrians feel pleasant and secure such as being well lit, clear of blind spots and with good sightline, free from littering, graffiti and vandalism, among others.
- (i) Consideration should be given to the provision of covers to at-grade walkways to offer some protection against inclement weather, strong sunlight etc. More details are given in TPDM Volume 2 Chapter 3.
- (j) To create an enjoyable walking environment, considerations should be given to the provision of building canopies, including over public footpath(s) and/or right-of-way(s) with reference to the following guidelines or their latest editions:
 - (1) Chapter 8 of the Hong Kong Planning Standards and Guidelines provides for the provision of building canopies (i.e. para. 5.6.11) and for the subject of pedestrian planning be included in development studies and planning applications (para. 5.9.2);
 - (2) "Projections over Public Streets" stipulated in Lands Administration Office Practice Note 3/2020 (Design, Deposition and Height Clause under Lease); and/or
 - (3) Buildings Ordinance, in particular Building (Planning) Regulation 10 in Cap. 123F regarding balconies and canopies over streets.
- (k) High-level canopy extending over part of the carriageway may be considered for bus stops, taxi stands etc.
- (xix) Signage is essential and should also be designed to address the needs of people with mobility impairments, sensory deficits and cognitive impairments. At present, traffic sign (TS114) 'Pedestrian Priority Zone' can be used to indicate the higher priority of pedestrians in the use of street space at streets with vehicular and pedestrian traffic. Traffic signs TS116/TS117 can be used to prohibit vehicular entry to full-time or part-time pedestrian streets where appropriate. More specific signage is being studied and developed.

- (xx) Partnership can be at every level. Bus operators can provide pedestrian friendly buses, position bus stops within walking distance from pedestrianized priority areas as appropriate in the planning of bus routes, offer training to drivers to let them be more considerate towards passengers and pedestrians, and improve the environment of waiting or queuing area for commuters. Property developers can provide full access on foot to the developments. There are wide scopes of potential applications.

10.5.3 Schemes (Toolbox) for Improvements

10.5.3.1 The key concept of urban grid of mobility and link and place approach for pedestrian ways under the PPF should be applied to consider pedestrian improvement measures at the district/ local level to achieve the four pillars of walkability, bringing in enhancement to pedestrian walking experience. This section discusses various types of pedestrian improvement measures, including details of pedestrian priority/traffic calming measures, applicability, characteristics, implementation and examples, which could be considered when proposing suitable schemes for pedestrian improvement measures. The list of pedestrian improvement measures under the four pillars of walkability could be found in Appendix B for reference.

10.5.3.2 In general, pedestrian schemes that could be considered include:

- (i) full-time pedestrian streets in which pedestrians have absolute priority. Vehicular access is restricted except emergency services. In some circumstances, service vehicles may be allowed in specified periods. Public transport such as tram with stringent speed control may also be allowed to travel through the pedestrian priority areas;
- (ii) part-time pedestrian streets in which vehicular access is only allowed in specific periods and there is no on-street parking space. However, loading bays are provided for loading/unloading. Closure periods depend on pedestrian activities on the streets;
- (iii) traffic calming streets in which footpaths are widened and there are limited parking spaces. There is no restriction to vehicular access. However, vehicles are slowed down through the use of traffic calming measures such as narrower traffic lanes and speed tables etc. The surface of carriageway is usually colour dressed in reddish brown to alert motorists' attention of the change of street character; and
- (iv) shared surface streets in which pedestrians have higher priority although road closure is not possible because of vehicular access requirements. The footways are flush with the carriageway. Pedestrians share the use of street space with vehicles. Operating speed is self-enforcing and should be below 25 kph, using traffic calming measures. This usually applies to dead end streets serving carparks, and streets where the footways cannot accommodate the pedestrian activities such as over spilling pedestrian movement onto the carriageways. The peak hourly vehicular traffic volume may reach up to 300 pcu (reference 7).

10.5.3.3 In the reallocation of street space, footpaths will be aggressively widened in favour of pedestrians to redress the imbalance in service standards and functions of the streets. The widths of carriageway, if any, would be maintained at lower bounds of the standards at streets where pedestrian activities dominate.

- 10.5.3.4 Full-time pedestrian streets provide vehicle-free environment for pedestrians. It applies to streets with established heavy pedestrian flows and light vehicular traffic with no access requirements. In some circumstance, permits may be issued to limited number of users accessing the buildings in which they are entitled to under lease. To implement full-time pedestrian streets, it is necessary to go through the procedures under the Roads (Works, Use & Compensation) Ordinance. Due consideration should be given to its land use compatibility with the neighbourhood and public views to avoid nuisances to nearby occupants and public criticism. Sometimes, the full closure option may not be feasible in the short term due to the magnitude of traffic involved. However, in the longer term, full-time pedestrianisation should be further explored after other schemes such as larger scale improvement works at parallel routes, traffic restraint measures and public transport restructuring etc.
- 10.5.3.5 Part-time pedestrian streets only allow vehicle to use at some specific hours. During the periods of pedestrianisation, the streets are close to vehicular traffic. Diagram 10.5.3.1 shows typical traffic signage and closure means at the ingress and egress. The entry of vehicles is prohibited by the ‘all vehicles prohibited in both directions’ traffic sign (TS116) erected on kerbside. Traffic sign TS117 may be considered if bicycles are not prohibited from entering. The supplementary time plate attached to the traffic signs TS116 or TS117 should tally with the period of pedestrianisation. The barrier mounted in the middle of the carriageway is informative and enforces closure of the section to vehicles. Due consideration should be given regarding its land use compatibility with the neighbourhood and public views to avoid nuisances to nearby occupants and public criticism.
- 10.5.3.6 The shared surface street offers a level surface across the street. The design of the scheme should be such as to maintain a clear distinction between footways and driveways. Bollards and tactile pavers may be used to demarcate the extent of the driveway. Diagram 10.5.3.2 shows typical details of shared surface streets with associated calming measures.
- 10.5.3.7 Pedestrian environment enhancements do not always imply full-scale pedestrianisation. Speed reduction, traffic restraint, wider pavements, more pedestrian crossings, shorter waiting times, longer crossing times and the removal of barriers all increase pedestrian priority without requiring full-time pedestrianisation.
- 10.5.3.8 Traffic calming streets target at vehicular speed and volume reduction through traffic calming measures to calm down the operating speeds between 30 – 45 kph, at the same time allowing reasonable flow of vehicular traffic. Subject to site constraints, minimum driveway is 3.5m wide with adjoining layby giving a total width of 6.0m minimum, meeting the Fire Services Department’s (FSD) requirements. Diagram 10.5.3.3 shows a typical section and a plan of a one-lane traffic calming street with an adjoining loading bay. Typical dimensions of other traffic calming streets are summarized as follows:

<u>Traffic Calming Street</u>	<u>Lane Dimension (m)</u>	<u>Remarks</u>
1-lane	3.5	With adjoining layby
2-lane	6.0 ~ 6.75	
3-lane	9.5	3.5+3.0+3.0

- 10.5.3.9 The actual dimensions should take account of the types and composition of traffic, public transport level, bus observations, demands for loading/unloading, parking requirements, and other site conditions.

**DIAGRAM 10.5.3.1: EXAMPLE OF CONTROL SIGNAGE AT INGRESS (TOP) AND
EGRESS(BOTTOM) OF PART-TIME PEDESTRIAN STREETS**

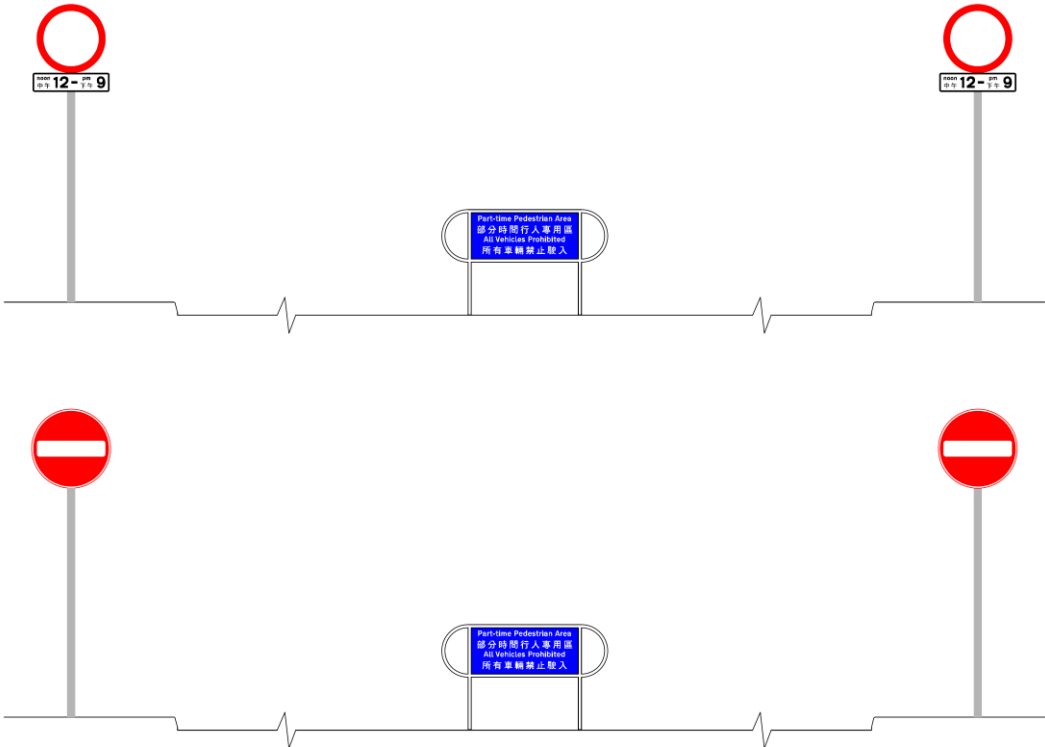

NOTES:
TRAFFIC SIGNS TS116 TO BE USED AT INGRESS
TRAFFIC SIGNS TS115 TO BE USED AT EGRESS
CONTROL GATE TO BE IN GRAY FRAME, WHITE WORDS
AND BLUE BACKGROUND

DIAGRAM 10.5.3.2: EXAMPLE OF SHARED SURFACE STREET

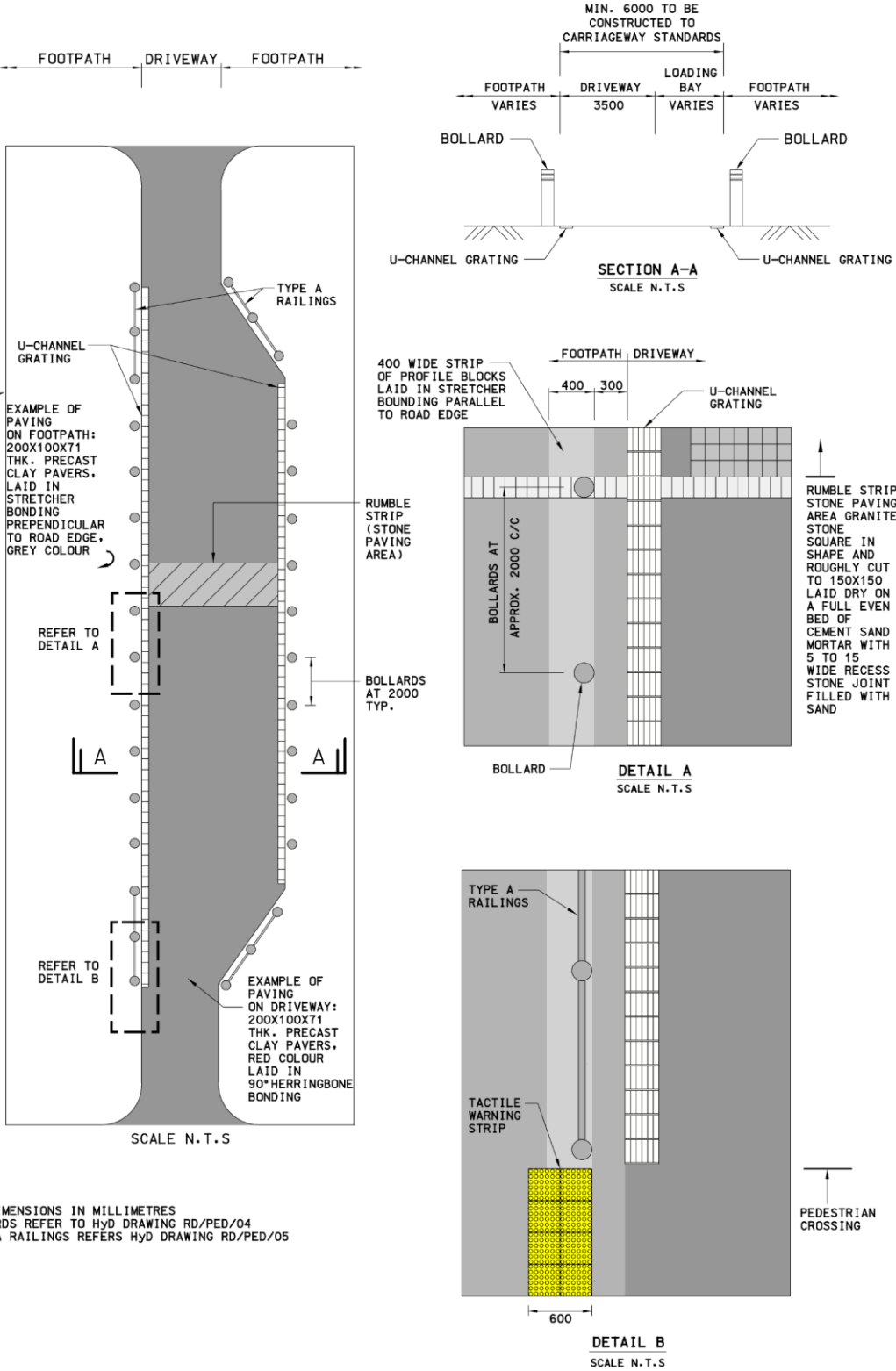

- NOTES:
1. ALL DIMENSIONS IN MILLIMETRES
 2. BOLLARDS REFER TO HyD DRAWING RD/PED/04
 3. TYPE A RAILINGS REFERS HyD DRAWING RD/PED/05

DIAGRAM 10.5.3.3: ONE-LANE TRAFFIC CALMING STREET WITH LAYBY

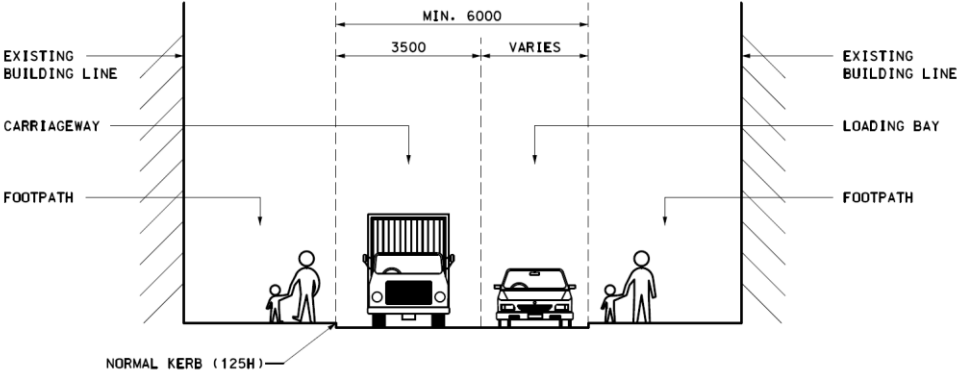

SECTION A - A

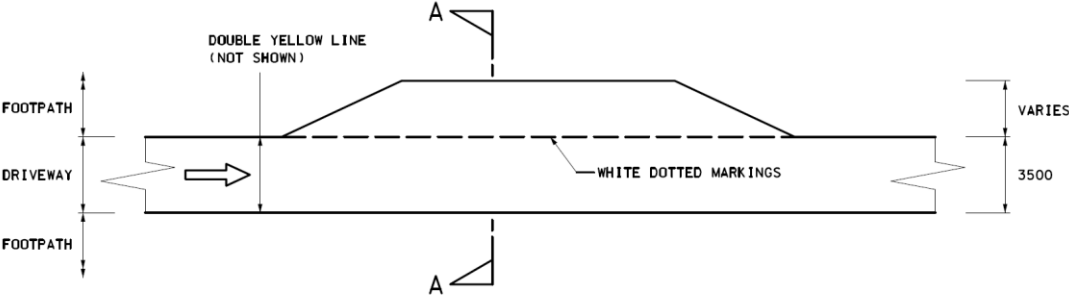

ALL TYPICAL DIMENSIONS IN MILLIMETER

10.5.3.10

Some traffic calming measures for carriageway width reduction and environmental and safety enhancement, with references to TAL10/00 (ref. 13), TUE and others, are summarized below for references. More guidelines are to be developed following satisfactory testing of the features for use on public roads. The measures presented here should not be taken as an exhaustive list of all the measures that are available and new measures are likely to arise, particularly with the developing role of information technology. Primarily, calming means are categorized into vertical shifts in vehicle path, lateral shift, and carriageway constriction. The selection depends on the classification of the street use and level and types of pedestrian activities.

- (i) Build-outs are a narrowing of the carriageway, constructed on one side of the road as an extension to the footway, and are often combined with flat-topped crossing facilities. Build-outs shorten the crossings' width and also enable pedestrians to have a better sightline of approaching traffic. Also refer to Diagram 10.5.3.4 for the schematic layout.
- (ii) Chicanes consist of two or more build-outs on alternate sides of the road, but not opposite one another, and create horizontal deflections. Chicane designs vary considerably. Generally, there are two broad categories. The single lane working consists of build-outs, staggered on alternate sides of the road, narrowing the carriageway so that traffic from one direction has to give way to opposing traffic. The two-way working uses build-outs to provide deflection, but with lanes separated by road markings, or a central island. Schematic layouts are shown on Diagram 10.5.3.4.
- (iii) Corner radii reduction can reduce approaching vehicle speed at turning, and assist pedestrians in street crossing by narrowing the carriageway width. A 1m-corner radius may limit the maneuvering speed to 20-25 kph, which would be half of those with a corner radius of 7m (Reference 17).
- (iv) Entry Treatment consists of a change of surface, a ramp, a narrowing or some other features at a junction or change of road characteristics such as type, colour, material, texture etc. (see also gateways). This alerts drivers to changes in street character and reinforces slower traveling speeds.
- (v) Footway Crossovers are the continuation of an existing footway across the mouth of a side-road, with vehicles allowed to cross the footway but giving way to pedestrians.
- (vi) Footway Widening, often as part of the redefinition of road space, is used to give more space to pedestrians or for planting. It may be part of a build-out and can be particularly effective at formal or informal pedestrian crossing points.
- (vii) Gateways are combinations of natural or man-made features at the entry to, or exit from, areas where the rules or drivers' expectations change, such as at the introduction of speed-limits. Signage and landscaping can act as simple gateway treatments.
- (viii) Horizontal Deflections occur at build-outs, chicanes and pinch points, often with priority signing.
- (ix) Islands usually take the form of a longitudinal island, built in the carriageway, with or without facilities for pedestrians, to improve lane-discipline, restrict overtaking or lower vehicle speeds by reducing lane-width.

- (x) Junction Priority Changes are used as part of an area scheme to interrupt long stretches of ‘through’ road. Care is needed in signing when introducing a change such as this.
- (xi) Junction Treatments can incorporate a variety of measures as part of an overall scheme, including flat-topped road humps, narrowing and removal of excess areas of carriageway and the introduction of ramps, chicanes, horizontal deflections, reduce visibility spray and tight curves.
- (xii) Mini-Roundabouts are used at junctions of long straight roads to break up the road into shorter sections, which slow traffic; also used at ‘T’ or ‘Y’ junctions to reduce the dominance of one particular flow.
- (xiii) Narrowings reduce the width of driveway and help reduce traffic speed.
- (xiv) One-Way Streets may be used as part of an area-wide scheme to break up a road into short sections and indirect routes to discourage through traffic while allowing free movement of public transport. Usually the scheme will provide more capacity for new crossings in favour of pedestrians. By creating detours, they can discourage ‘rat running’ but may encourage higher speeds because of the absence of opposing traffic. Contra-flow bus lanes or cycle routes may be incorporated.
- (xv) Optical Width makes vehicles travel at lower speeds when vertical elements along the street are greater in height (H) than the street’s width (W) i.e. $W/H < 1$. This may be achieved by using trees, bollards or other entry gates etc to reduce optical width.
- (xvi) Pedestrian Refuges are used to aid pedestrians’ crossing movements, by allowing a carriageway to be crossed in two stages. Pedestrians can have a stopping place to check the traffic conditions prior to crossing the second half of the roads, in particular at cautionary crossings of single carriageways. Adequate size is required. They are also used to control overtaking and to improve lane discipline.
- (xvii) Pinch Point consists of a pair of build-outs on opposite sides of a road to create a narrowing, thus helping to modify vehicle speeds and to reduce the risk to pedestrians when they cross the road. The narrowed carriageway at these points means that pedestrians, particularly children, have less carriageway to cross, and can therefore complete their crossing movement more quickly. Schematic layout is shown on Diagram 10.5.3.4.
- (xviii) Planting can be used to change the perceived width of a road, to define a gateway and to improve the overall environment.
- (xix) Raised crossings or a raised junction with crossings at any legs are raised to match the level of adjacent footpath. They slow down the moving vehicles by introducing vertical deflection in the form of a plateau (flat-topped road hump) and provide a flat surface for pedestrians to cross on the same level in a continuous manner. When installed at the entrance of a minor road, such as low speed limit zone, the raised crossing/junction is referred to as a “gateway” treatment to prevent motorists from speeding when entering the minor road from a major road. More details are given in Section 10.5.3.11.
- (xx) Levelled run-ins provide pedestrians with continuous footpaths at vehicle crossovers and therefore promote walkability as well as accessibility, comparing with ordinary vehicular run-ins design which encroach on a substantial portion of a footpath and creating level differences both longitudinally and transversely across the footpath

alignment. Levelled run-ins also aim to slow down approaching vehicles before crossing over the footpath. More details are given in Section 10.5.3.12.

- (xxi) Colour dressing at cautionary crossing with details are given in Section 10.5.3.13.
- (xxii) Road Humps are used to reduce vehicle speed and, in the case of flat-topped humps, may provide a level surface for pedestrians to cross. Others include round-top humps, which are normally 3.7m long (also see Chapter 5 Volume 2 of TPDM) and speed cushion. Most level changes between 50 to 100 mm. Road humps are similar to raised junctions. It is recommended that road humps should not be closer than 50m apart. The maximum spacing between humps exceeds 100m may increase the 'between humps' speed significantly. Spacing in excess of 150m, for any types of hump, is not recommended. It should caution that humps may affect public transport and emergency vehicles. TRL research reveals that passengers in buses and emergency vehicles find round-top road humps more comfortable than the straight-ramp flat top road humps in the range 15 to 40 kph. The impacts on discomfort, noise, ground-borne vibration, and emissions should be addressed. Reference 13 refers to.
- (xxiii) Road Markings are used to hatch out areas of carriageway, to define traffic lanes and to create the visual effect of narrowing of the carriageway. 'Dragon teeth' is one of the examples.
- (xxiv) Roundabouts are used to stop through traffic and facilitate turnings at junction, in particular between minor roads with moderate traffic. Adverse impacts may be noise and air pollution due to stop and go at roundabouts.
- (xxv) Rumble Devices are part of a carriageway made of materials, which create a noise or vibration as vehicles pass over. They are useful as an alerting device before a hazard but may not reduce speed. The noise may attract objections when sited close to dwellings and becomes significant when speeds exceed 25 kph (Reference 17). More details in TPDM Volume 2 Chapter 5.
- (xxvi) Strips, occasional strips can be surface treatment either in colour or texture placed along sides or in the median of the carriageway. This visually decreases the perception of carriageway width. In UK, Netherlands and Germany, they are found effective on roads with service speeds up to 30 kph (Reference 17).
- (xxvii) Speed Cushions are a form of road humps, occupying only part of a traffic lane, which, generally, can be spanned by buses and HGVs but not by cars and can be used in conjunction with chicanes.
- (xxviii) Surface Treatments consist of change in the colour or texture of a carriageway, to denote where the character or use of the area changes.

DIAGRAM 10.5.3.4: TYPICAL LAYOUTS OF BUILD-OUT, CHICANE AND PINCH POINT

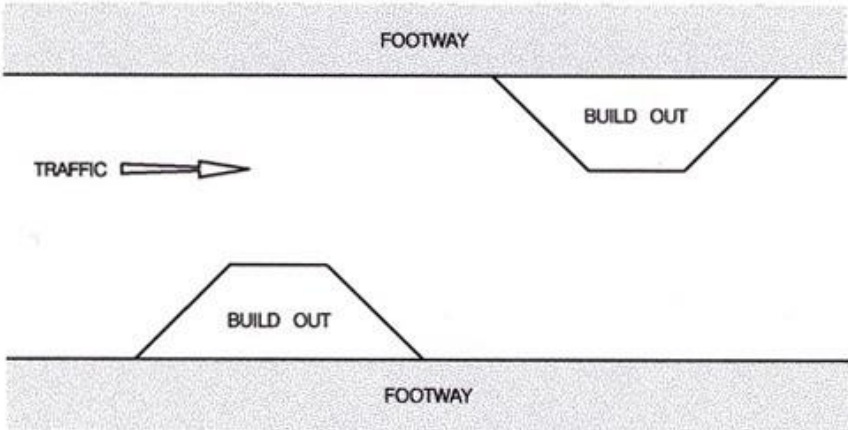

ONE-WAY WORKING CHICANE

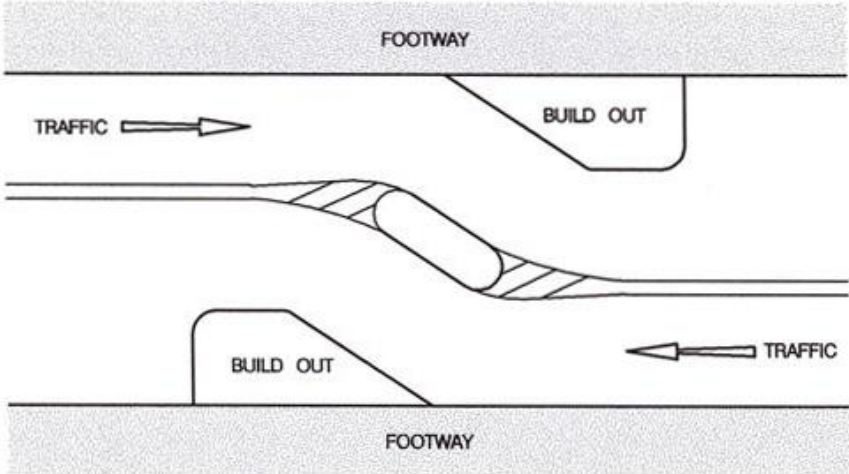

TWO-WAY WORKING CHICANE

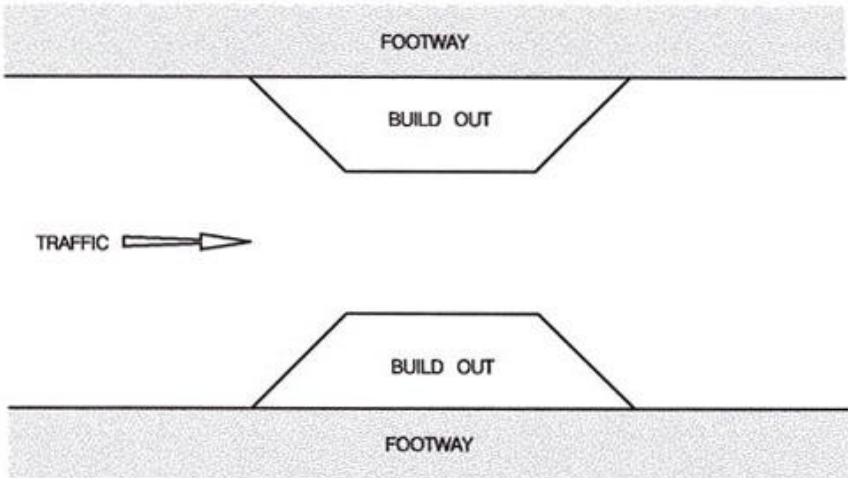

PINCH POINT

10.5.3.11

- (a) Raised crossings/junctions are used as traffic calming measures at zebra crossings and uncontrolled cautionary crossings near pedestrian-centric locations, such as schools, elderly and rehabilitation centres, residential areas and commercial centres where there is a focus on pedestrian movement and safety. Raised crossings/junctions are preferred at one-way one-lane roads or one-way/two-way two-lane roads with overall width less than 10m. Other traffic calming measures, including but not limited to build-outs or pinch point, can be applied with raised crossings/junctions. However, the use of raised crossing/junction on roads with steep gradients is not recommended as in the uphill direction slower vehicles can find them difficult to negotiate and under adverse weather conditions in both directions of travel they are potentially dangerous.
- (b) Road surface of the raised crossings/junctions is raised to the level of the footpath surface, which is normally 125mm from the surface of the carriageway.
- (c) For raised crossings/junctions on non-bus routes, a minimum plateau length of 3m with a ramp gradient of 1:10 should be provided. Subject to site constraints, such as matching with road gradient/profile, the actual ramp gradient may be adjusted and be determined based on site condition while being no flatter than 1:20. The plateau length should provide sufficient crossing width taking into account pedestrian demand. Typical layouts of raised crossing/junction on non-bus routes are shown on Diagram 10.5.3.5.
- (d) For raised crossings/junctions along bus routes, ramp gradient of 1:20 with minimum plateau length of 10m is recommended. Minor adjustment of the ramp gradient may be adopted to suit the site conditions. The plateau length may be increased to provide sufficient crossing width taking into account pedestrian demand. Typical layouts of raised crossing/junction along bus routes are shown on Diagram 10.5.3.6.
- (e) Raised crossing/junction installation may consist of a single crossing/junction or a series of crossings/junctions at a spacing of 50m to 100m. For installation of a series of crossings/junctions in low speed limit zones, a minimum clear spacing of 50m is recommended as traffic calming measures. No more than five raised crossings/junctions are recommended on any bus routes in order not to induce excessive discomfort to passengers.
- (f) The surface of raised crossings/junctions should be colour dressed in reddish brown to alert motorists' attention of the change to street character.
- (g) Road markings at raised junctions/crossings should be painted as shown in Diagrams 10.5.3.5 and 10.5.3.6.

- (h) Railings should be provided near the crossing point as shown in Diagram 10.5.3.7 as to stop pedestrians crossing over the ramps and to prevent people with visual impairment from walking onto the carriageway outside the crossing points. A minimum buffer distance of 0.3m between the edge of crossing and the ramp should also be provided if site condition permits to avoid people with visual impairment from stepping on inclined road surface. The same principle should be followed for full raised junctions which span across the different legs and should be designed according to the junction geometry.
- (i) Tactile warning strips should be provided at crossing point as shown in Diagram 10.5.3.7.
- (j) Adequate drainage must be provided at or adjacent to the raised junctions/crossings. Advice from Highways Department should be sought.
- (k) If a raised crossing/junction is required at roads with bend, the ramp of raised crossing/junction should not be within 18m of the tangent point of the bend with an inner kerb radius of less than 50 metres and which requires a vehicle to change direction by more than 45 degrees.
- (l) Provision of physical island on raised crossing/junction is not recommended. Designer should consider carefully when implementing a raised crossing/junction where physical island is present.

DIAGRAM 10.5.3.5 : TYPICAL RAISED CROSSING/JUNCTION ON NON-BUS ROUTES

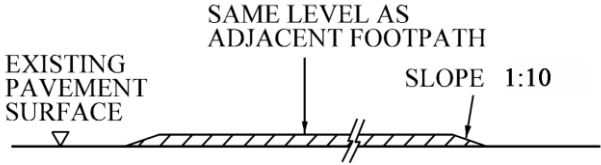
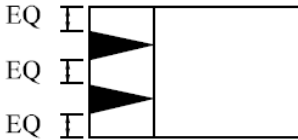
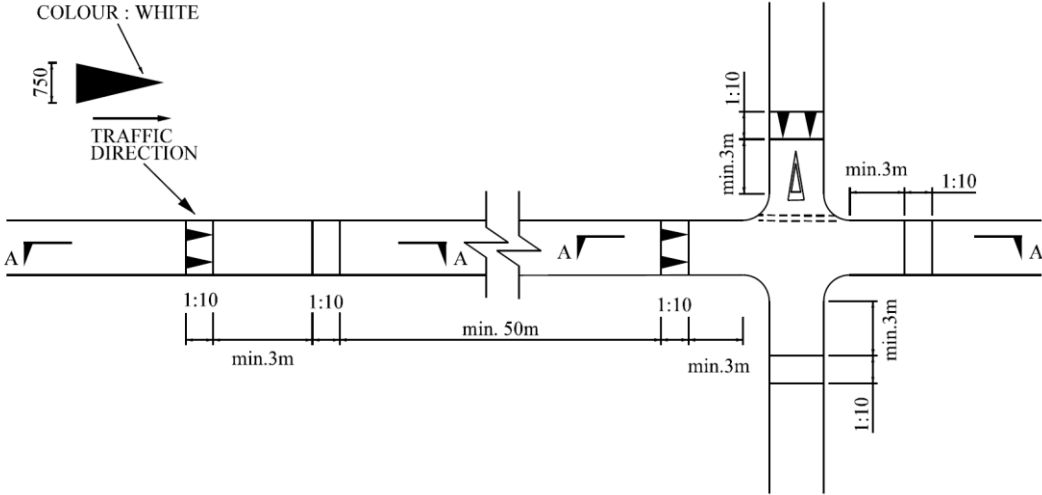

Typical road marking arrangement

Section A-A

DIAGRAM 10.5.3.6 : TYPICAL RAISED CROSSING/JUNCTION ON BUS ROUTES

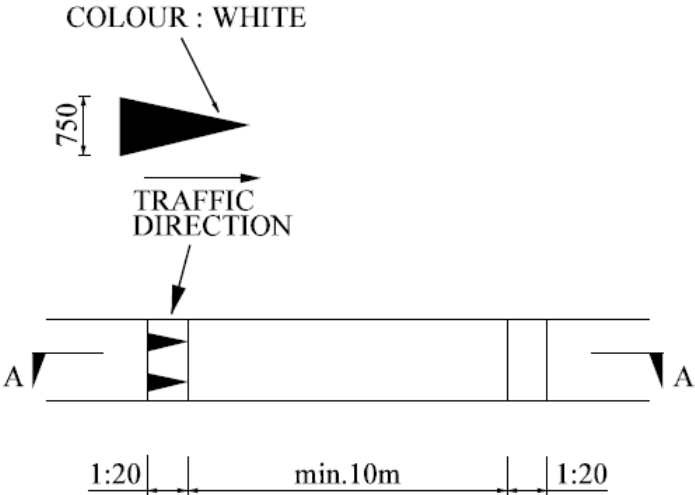

Raised crossing on bus routes

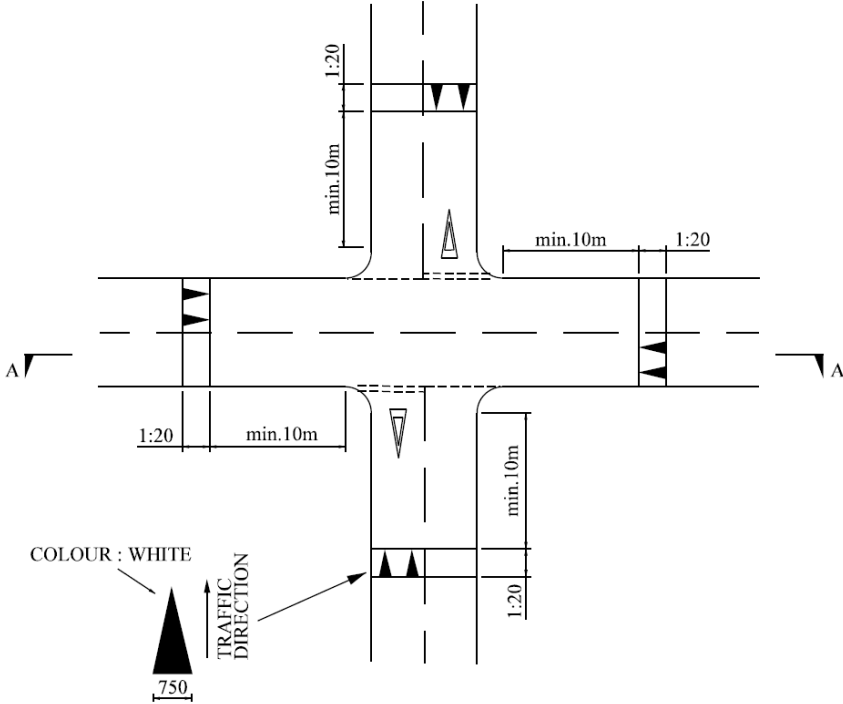

Raised junction on bus routes

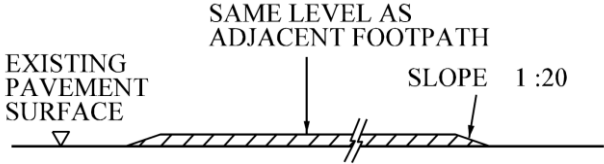
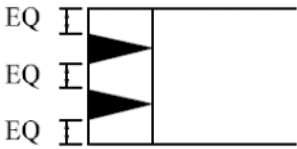

Typical road marking arrangement

Section A-A

DIAGRAM 10.5.3.7 – TYPICAL ARRANGEMENT OF TACTILE WARNING STRIPS AND RAILINGS AT CROSSING POINT

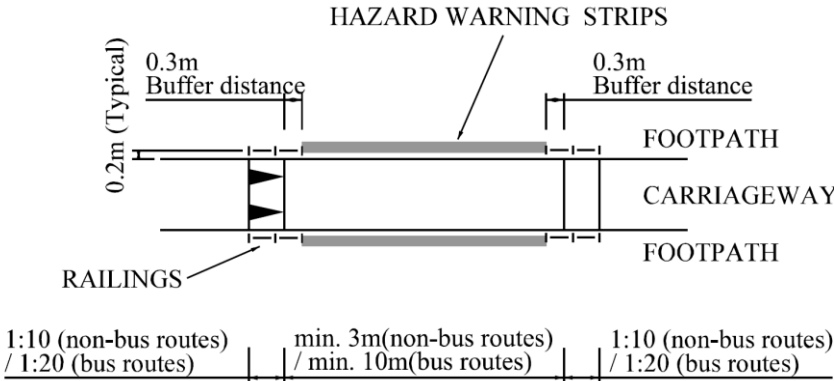

10.5.3.12

For provision of levelled run-in, the following design details should be followed:

- (a) The levelled run-in maximises the width of level and continuous footpath by adopting a shorter ramp / kerb with 15% gradient (slope angle 1 in 6.67) for vehicle mounting, followed by a minimum cross fall of 2% towards the run-in on the remaining footpath portion. A typical layout of levelled run-in is shown at Diagram 10.5.3.8. Levelled run-ins may be applied at a footpath where width of level surface after provisioning of levelled run-in would not be less than 2 metres or certain width for achieving LOS C, whichever the higher. In particular, those vehicular run-in with higher amount of vulnerable pedestrians (including the elderly, disabled and children) walking across, such as vehicular accesses to schools, elderly centres, rehabilitation centres and in their vicinity without public parking spaces, could be considered for adopting levelled run-in where applicable.
- (b) Road marking with contrasting colour should be adopted on the shorter ramp portion of levelled run-in as the visual contrast for warning motorists and pedestrians of the sloped surface. The general layout of road marking for levelled run-in is shown at Diagram 10.5.3.9.
- (c) Different colour paving with reference to Highways Department's "Guidance Notes on Design and Construction of Pavements with Paving Units – RD/GN/044C (or any further updated version)" and relevant Highways Department Standard Drawings should be used at the levelled run-in as extra safeguards to alert pedestrians to potential crossover traffic at footpath.
- (d) For other general design requirements of run-ins, TPDM Volume 2 Chapter 3.6 and Volume 6 Chapter 8.10 should be referred.

DIAGRAM 10.5.3.8: TYPICAL LAYOUT OF LEVELLED RUN-IN

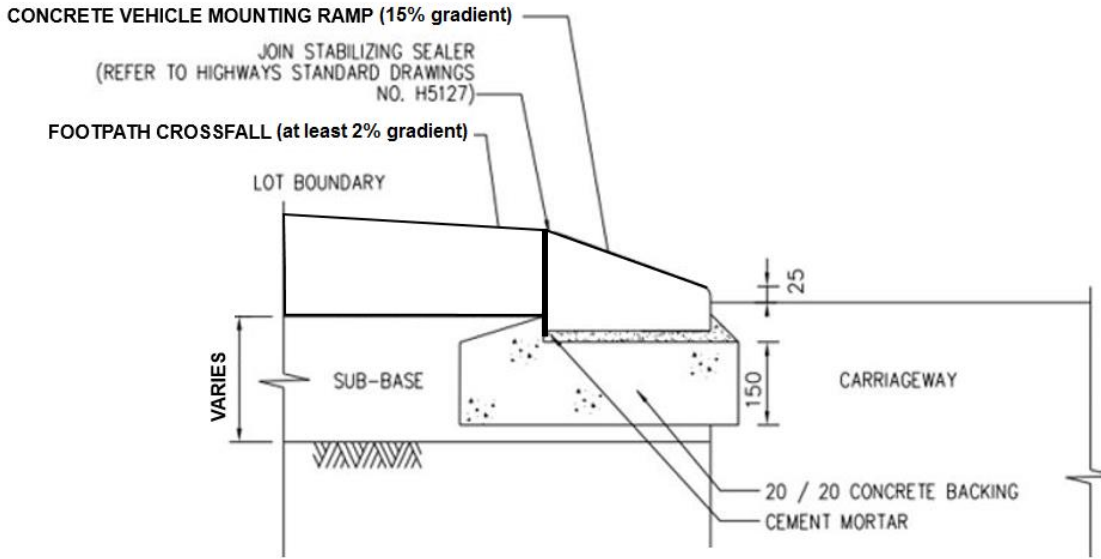
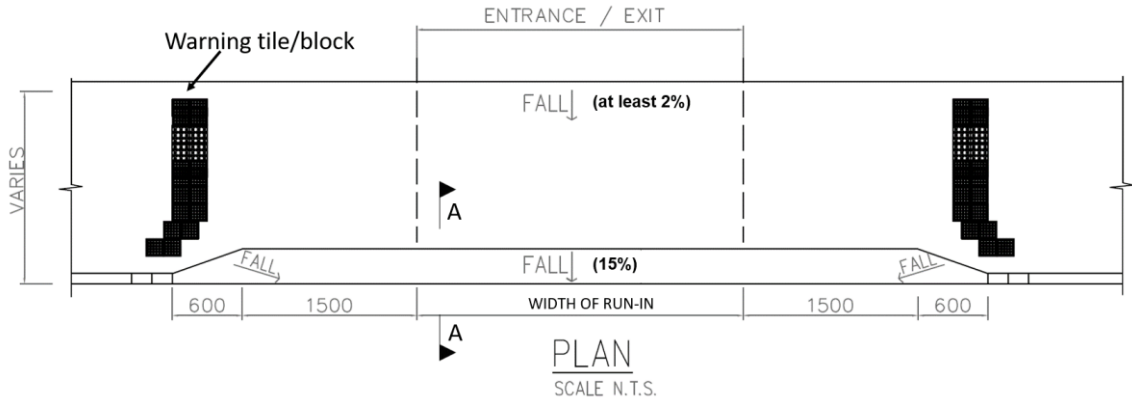

Section A-A

DIAGRAM 10.5.3.9: ROAD MARKING FOR LEVELLED RUN-IN

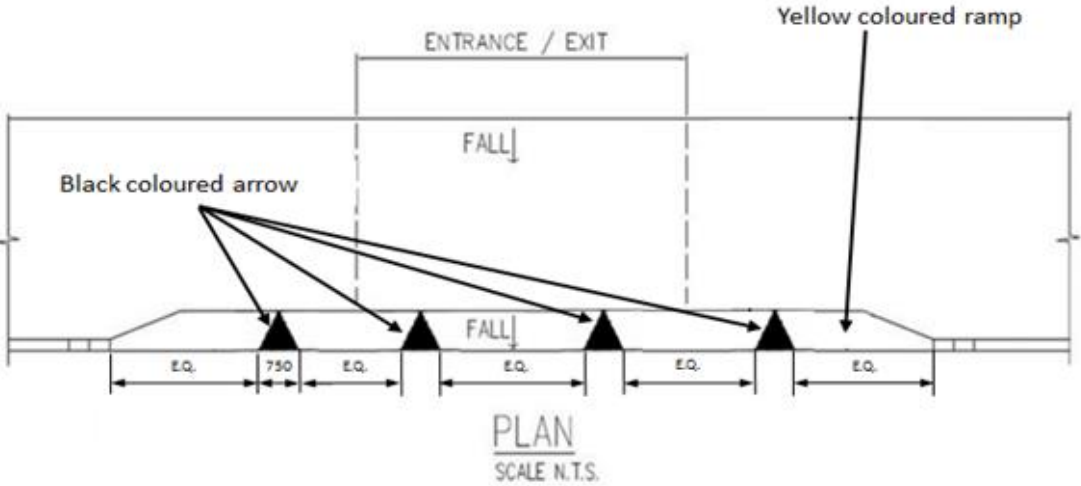

10.5.3.13 In order to alert motorists' attention on the presence of cautionary crossing where pedestrians, in particular vulnerable pedestrians (including the elderly, disabled and children) may exist, the whole width of cautionary crossings might be considered to be paved with reddish brown colour dressing on the surface of carriageway, at locations with higher amount of vulnerable pedestrians, such as those near residential areas, schools, elderly and rehabilitation centres, taking into account the accident statistics. In particular, application of colour dressing at cautionary crossing with the existence of any of the following situation(s) is recommended.

- (a) located between two signalised junctions, and would run the risk of being overlooked;
or
- (b) at roads where observed traffic speed is relatively high.

10.5.4 Implementation of Pedestrian Improvement Measures

10.5.4.1 On top of the established practices for formulating pedestrian improvement measures, the PPF provides a comprehensive and holistic framework in pedestrian planning with respect to the relative functions of the pedestrian ways under the concept of urban grid for mobility and link and place approach for pedestrian ways. On this basis, schemes for pedestrian improvement measures could be designed. In the development of the schemes, there may well need to be compromises between the conflicting wishes of different interest groups.

10.5.4.2 While designing for the pedestrian improvement measures, various types of assessment are required to select the recommended scheme. Apart from achievement of the relevant objectives of the four pillars of walkability, here are some criteria to be considered while selecting the recommended scheme for the pedestrian improvement measures:

- (i) to demonstrate that schemes have been selected rationally and in accordance with the objectives;
- (ii) to compare and prioritize scheme design options;
- (iii) to compare and prioritize competing pedestrian schemes; and
- (iv) to demonstrate that schemes represent value for money.

- 10.5.4.3 There may not be a single appraisal method which satisfies all these requirements and which is cheap and easy to operate. The level of sophistication of appraisal will depend on the value of the scheme: a low budget scheme will warrant only a simple assessment. Major issues include environment, safety, economy, accessibility and integration. Some appraisal methods are listed.
- (i) Priority ranking system - typically this awards points to schemes under a number of assessment criteria, often including factors such as the volume of traffic, LOS, pedestrian movements, number of accidents, locations and degree of benefit to the user that is likely to result. Point may be weighted according to the policy priorities. Priority ranking systems are easier to devise, and produce more meaningful results, when they are used to compare similar types of scheme. Objective criteria, that can be readily quantify, such as pedestrian delays or flows, tend to be easier to incorporate into priority ranking systems. The number of assessment criteria should not be too large and the method should not be data hungry.
 - (ii) Cost-benefit analysis – it needs to show the scheme offers value for money. Usually, this will be more important for large schemes. It has advantage over priority ranking methods that, in principle, all types of scheme can be compared within one framework because many quantifiable costs and benefits are converted to a common unit. With accurate standard values for working time, non-working time, casualties etc., a comprehensive cost-benefit analysis may be appropriate to large scale pedestrianisation. A drawback is that it can be difficult to quantify some items (notably indirect costs and some benefits, such as health benefits from walking) and even difficult to give them a monetary value.
 - (iii) Local safety scheme appraisals – These focus on the number and types of casualties expected to be saved, and the cost of measures for each schemes.
 - (iv) Goal achievement matrix – these are established methods for assessing schemes or options against multiple criteria, with or without quantification. They are more flexible than priority ranking and cost-benefit analysis methods. However, they do not offer the same precision as these other methods. They are useful in helping selection of schemes that meet policy objectives. They also help to prioritize pedestrian schemes relative to other pedestrian schemes.
- 10.5.4.4 There should be detailed description about the traffic rerouting and impacts on motorised traffic and associated activities of public transport (franchised bus, MTR, tram, taxi, minibus etc.), resident's coach services, goods vehicles, parking, loading/unloading and the likes, where appropriate. For RMB and taxis, in particular, the existing passenger catchment area and length of stands should be taken into account. Taxi operators may object to potential loss of trade and longer journey– lengths for their customers, so taxi stands should be located so as to minimize inconvenience. A plan showing all stands, relocation of facilities, revised routes, parking of motor cycles and people with disabilities, among others is recommended for the public transport and parking re-organization.
- 10.5.4.5 Plans up to traffic aids level are required to show the street/road layout, alignment, traffic calming measures, designated loading bays, parking for people with disabilities, on-street motor-cycles parking space, GMB and RMB termini, taxi stands, and other traffic aids.

10.5.5 Traffic Impact Assessment (TIA)

- 10.5.5.1 TIA should be carried out in accordance with relevant clause in the TPDM and the latest available departmental guidelines. In cases related to the provision of pedestrian priority/traffic calming areas, the intent is to divert non-essential traffic from the pedestrian priority/traffic calming areas. TIA is necessary to be carried out as and when appropriate to review whether the road network has sufficient capacity to take up the re-assigned traffic at alternate routes. Parallel improvements such as junction widening, re-design of signal at junctions, imposition of 'no stopping zones' etc. will augment the capacity and help circulation of traffic at the peripheral.
- 10.5.5.2 The surveys of the existing traffic volume give the base year data. Traffic flows after re-assignment can be generated from models in which SATURN is one of the popular reassignment models. Provided that there is no major change of land use, transport infrastructure and transport policy (traffic restraint measures or public transport rationalization etc.) such that there is no strategic impacts on the study areas, analysis may also be taken using aggregate traffic growth factor method based on screen line flows extracted from relevant study models. Reference can be made from BDTM. Comparisons of link flows for the before and after scenarios on plans are helpful to reveal the traffic flows and pattern changes.
- 10.5.5.3 Computer modeling of pedestrian activities sometimes may not be cost effective. Local experience and knowledge may often be more valuable. Development of computer models to forecast pedestrian travel patterns may be justified for large scale pedestrianisation schemes and/or for planning purposes. In general, there are several common approaches to model pedestrian movements, namely: regression analysis, accessibility, fluid-flow analysis, and spatial interaction.
- 10.5.5.4 It is advisable to present the traffic volumes of existing and testing scenarios in table forms with the changes in both figures and percentages. The comparisons of link flow indicate the main traffic diversion and any noticeable increase along a particular link.
- 10.5.5.5 Comparisons of capacity at junctions can indicate whether they have room to absorb the diverted traffic or improvement at the junctions is necessary. The desirable limit of reserve capacity (RC) is 10% or above for signal-control junctions; and that of volume to capacity (V/C) ratio is less than 0.85 for links (reference 9). However, improvement schemes with RC being less than the desirable limits may be still beneficial to the network provided that the implementation can improve the existing situations.
- 10.5.5.6 In the urban areas, most signals may have been coordinated. The combined effects should be investigated in response to the effects on individual signal junctions.
- 10.5.5.7 The pedestrian improvement measures should be considered by making reference to existing traffic and pedestrian situations. In order that the pedestrian facilities to be provided can cope with near future situations, it is necessary to account for the forecast of the traffic volume and travel patterns.
- 10.5.5.8 Pedestrian improvement measures can also be planned for new pedestrian activity nodes and/or anticipated change of travel patterns because of new transport infrastructure and/or transport policies. Pedestrian activities nodes include venues of social/community/spots/cultural/ facilities, centres for people with disabilities, residential/commercial complex, and PTI.
- 10.5.5.9 The change in land use may affect existing travel patterns. Within the study area, records of known or anticipated major change in land use such as new developments and redevelopment of sites should be taken into account in the pedestrian improvement measures. For example, bottleneck at footpaths may be resolved by setting back the building going to be redeveloped and/or the incorporation of public passageways within the redevelopment. New developments may be walking trip generation/attraction. The effects of land use change are long term issues and thus there may be staged adjustments of the proposed scheme.

10.5.5.10 This also applies to any major changes of transport policies and transport infrastructure including transport interchange, Park and Ride facilities, car park, at-grade or elevated new roads, retail/commercial frontage, development setback for footpath widening, footbridge/subway landings or traffic improvement measures. This will enable the major origin/destination walking trips patterns and the principal pedestrian routes within the study area to be adjusted if necessary. Other traffic management measures may also affect the travel patterns. For example a new pedestrian crossing would divert the flow to a new route. The provision of a short-cut, say a footway between two buildings, will reduce the original flow in the downstream direction. The travel pattern changes.

10.5.5.11 Consideration should be given to the spiral effect following the increase in the attractiveness of the areas after implementation. A comfortable street environment will attract more people spending more time on the streets. This will benefit retail shops, which attract more people at the pedestrian corridors.

10.5.6 Consultations and Publicity

10.5.6.1 In recent years, pedestrian schemes have become popular and economically successful. Well designed and managed schemes have returned vitality to the streets, making them interesting and attractive places to be. Compared with investing in other methods of transport, it can be relatively cheap to invest in improving conditions for walking. And it benefits the whole community.

10.5.6.2 One of the key elements in this success is careful consultation, and ensuring that appropriate provision is made for, amongst others, locals, shop owners/operators, people with disabilities (who may often rely on cars), public transport and deliveries.

10.5.6.3 Use of successful examples of developed schemes and photomontages of proposed schemes will help explain their benefits and ease off worries about their impacts.

10.5.6.4 Generally, the Government Departments, public, public transport operators, and the trades are mainly involved in the processes of consultation. Full and early consultations on proposals are essential. Consultations create a dialogue with the intended users (clients) in developing best practices.

- (i) Consultations with relevant Departments should include the Environmental Protection Department (EPD), Fire Services Department (FSD), Food and Environmental Hygiene Department (FEHD), Highways Department (HyD), Home Affairs Department (HAD), Hong Kong Police Force (HKPF), Lands Department (LandsD), Leisure and Cultural Services Department (LCSD), Planning Department (PlanD) etc. In particular, the FSD must be consulted on their needs for access to frontage premises and to the street itself.
- (ii) In public consultations, it is important to identify the interests of the target audience so that the relevance of the proposed schemes could be outlined to address their interests, get their involvement and gain their recognition.

- (iii) Benefits to the community and to a wider context of global concerns may not always be the prime interest of most people. Imminent advantages would be more beneficial. Some examples of benefits and dis-benefits are given below.

Impacts	Beneficiary	Dis-beneficiary
Enhancement of the pedestrian environment - provide catalyst effect for improvements to the adjacent environment through redevelopment, rehabilitation and facelift schemes	Customers, Land and property owners	
Commercial prosperity - increase in commercial viability for commercial enterprise	Retailers and Customers	
Land value - rise in land value	Land and property owners	
Cut cost and travel time - less out-of-pocket expense, and direct of door-to-door transport mode	Pedestrians/Customers	
Social disruption - gentrification		Low income residents

- (iv) It is important that local people and local business have a real say in the way pedestrian schemes are planned and provided. Comprehensive consultations with the public are necessary before drawing up the plans. Interest groups concerned with mobility, other walking issues and the environment, among others, can offer good ideas and specialist advice. There are various channels to communicate with the public such as:
- (a) District Councils in DC meetings, Traffic and Transport Committee meetings, Area Committee meetings, Working Group meetings;
 - (b) smaller interested parties such as owners' corporations, property management companies, local residents groups, shop owners/operators and individuals;
 - (c) public meetings/ briefing sessions are forum to meet most people within the study area to exchange information about the schemes for further refinements; and
 - (d) organizations of people with disabilities including mobility and visual/hearing impairments.
- (v) Local representatives would be more concerned about the traffic congestion and accidents statistics while local retailers are more concerned whether the new proposals would attract more pedestrians in to the area.
- (vi) Consultations with public transport operators and trades should include franchised bus companies, Taxi Associations, Public Light Bus Associations, Green Mini Bus Associations, Goods Vehicle Drivers Associations, Trucking Industry Associations, and Public Omnibus Operators Associations.

10.5.6.5 Publicity for pedestrianisation is campaign to change the attitudes to walking. It needs to take place alongside efforts to improve the environment.

- (i) It may achieve the public knowledge and awareness of pedestrian schemes through normal publicity mechanisms of roving exhibition at major pedestrian attraction venues such as rail stations and shopping complex, distribution of brochures/pamphlets, questionnaires (public views, trip purpose, awareness of schemes etc.) and dissemination of information through web sites.
- (ii) Forum will be another effective opportunity for exchange of opinion and share experience of pedestrian priority strategies with counterparts of other department, overseas officials, academics, concern/ pressure groups etc.
- (iii) Activities in connection with pedestrian priority/traffic calming areas such as opening ceremony, gazette, press release, press conference, and notices (to press, radio and special channels of transport information) can draw the attention of the media to advocate the improvement schemes widespread reporting.

10.5.7 Implementation Programme

10.5.7.1 Implementation programme

- (i) The implementation programme may span over several years and in different phases. It needs to take account of works of the Drainage Services Department, Water Supplies Department and utilities companies.
- (ii) The street-base (stand-alone) improvement schemes may be implemented as part of a single phase whereas complex and inter-related schemes over the whole area may need staged implementation. A stepped approach on a street-by-street basis is recommended to generate support and diffuse impacts on the affected parties of the schemes over the construction. This provides opportunity to review the schemes sensitive to the local responses.
- (iii) Experience suggests trials before the measures being put in place long term. Trials may start with marking out the carriageway by road-marking, water-fill temporary barriers and/or temporary concrete paving to the final streetscape design work. A grace period over the transition can enforce the concept of the schemes, educate the public (distribution of leaflets), and allow people to be familiar with the new measures, both policies and transport infrastructure.
- (iv) Because of the prominent nature of the pedestrian improvement schemes, it may be necessary to consider longer than normal road opening restriction periods in pedestrian priority/traffic calming areas, in order to protect the aesthetically pleasing environment and avoid inviting public criticism of lack of planning and coordination among utility undertakings.
- (v) Distribute leaflets of detouring routes, time and location of closure of streets, and any special measures to motorists and shop operators a few days before the implementation of full-time or part-time pedestrianisation

- (vi) The implementation programme, usually in PERT charts, may be presented with key milestones. The programme need to take account of consultations, resolution of objection if any, publicity, design, diversion of utilities, scheme trial, and implementation/street beautification. The programme may be developed with reference to the following objectives and preference:
 - (a) derive short-term measures to address immediate requirements;
 - (b) gain public recognition and support to the proposed schemes; and
 - (c) expand improvement schemes over larger areas.

10.5.8 Monitoring of Implementation

10.5.8.1 Monitoring of the implementation

- (i) There will be little benefit in preparing and agreeing on OPPs or the like unless there is a system of control, which will ensure the following actions:
 - (a) that the various proposals in the OPPs or the like are implemented in accordance with an agreed programme; and
 - (b) that the programme and details of the various proposals be updated from time to time and any necessary adjustments/amendments be made to cope with any change in environment and demand.
- (ii) For the smoothness and maintaining the momentum of implementation, progress monitoring group, task groups, and working groups are established to closely monitor the progress and to resolve problems in the implementation of the measures. These groups are attended with representatives from relevant bureaux/departments, including the Transport and Housing Bureau (THB), related regional traffic engineering divisions and transport operation divisions, HyD, HKPF, relevant District Offices (DO), FEHD, FSD, LCSD and etc.

Appendix B

List of Pedestrian Improvement Measures under Four Pillars of Walkability – “Making It Connected”

Item	Making It Connected					
	1. Continuity – Provision of crossings and continuous pedestrian routes	2. Accessibility – Easy access of population to key community facilities by walking	3. Integration with public transport – Easy connection to key public transport nodes by walking	4. Permeability – Permeable urban fabric for walking	5. Multilevel connection – Easy pedestrian connection to destinations through different levels in urban core	6. Inclusive mobility – Wheelchair access along pedestrian routes, barrier free access at junctions and level changes, barrier free access to MTR stations
	<p><u>New crossings</u></p> <ul style="list-style-type: none"> At grade crossing (preferred) Grade separated crossing (footbridge, elevated walkway, subway, underground walkway) <p><u>Crossing improvements</u></p> <ul style="list-style-type: none"> Improve location/capacity of crossing Convert staggered crossing to direct crossing Implement Area/Diagonal crossing at wide and congested junctions <p><u>Continuous footpath</u></p>	<p><u>Walking to key community facilities</u></p> <ul style="list-style-type: none"> Facilities such as kindergartens, primary schools, market facilities and health care facilities within walking distance 	<p><u>Walking to key public transport nodes</u></p> <ul style="list-style-type: none"> Continuous pedestrian routes within walking catchment of MTR station, PTI, major bus stop and ferry pier 	<p><u>Permeable pedestrian network</u></p> <ul style="list-style-type: none"> Crossing interval of 150m Block length or sub-block length of 150m Revitalization of laneways 	<p><u>Integrated multi-level walkway system to destinations</u></p> <ul style="list-style-type: none"> At grade, elevated and underground pedestrian ways Public passageway through buildings Pedestrian way through public spaces 	<p><u>Enhanced footpath standard for wheelchair access</u></p> <ul style="list-style-type: none"> Minimum 3 m wide footpath <p><u>Barrier free access at junctions and level changes</u></p> <ul style="list-style-type: none"> Dropped kerb Ramp Tactile warning strip <p><u>Enhanced standard for wheel chair access to MTR stations</u></p> <ul style="list-style-type: none"> At least two barrier free accesses with elevator to MTR stations provided by MTR or others (e.g. underground

	<ul style="list-style-type: none">• Level run in/out <u>Facilities to overcome steep gradient, level difference and long walking distance</u> <ul style="list-style-type: none">• Hillside escalator link• Lift at walkway• Travellator					link via adjacent development)
--	---	--	--	--	--	--------------------------------

List of Pedestrian Improvement Measures under Four Pillars of Walkability – “Making It Safe”

Item	Making It Safe			
	7. Vision Zero – Zero pedestrian accidents on roads	8. Rebalanced priority for pedestrians – Reducing conflict with vehicular traffic	9. Perception of safety – Vibrant pedestrian routes to reduce potential for crime	10. Safe sloping/stepped streets– Mitigating hazard at footpath
	<p><u>Zero killed or seriously injured (“KSI”) for pedestrians on roads</u></p> <ul style="list-style-type: none"> • Promotion of pedestrian safety and traffic enforcement 	<p><u>Traffic calming</u></p> <ul style="list-style-type: none"> • Kerb build-outs • Pinch point • Chicane • Reduction of corner radii • Narrowing of carriageway • Raised junctions / crossings • Entry treatment • Gateway • Level surface <p><u>Traffic speed management</u></p> <ul style="list-style-type: none"> • Low speed limit zone e.g. for areas with vulnerable pedestrian groups such as in school zone 	<p><u>Functionally active building frontage</u></p> <ul style="list-style-type: none"> • Land use planning, urban design and building design • Street lighting 	<p><u>Reducing pedestrian hazards</u></p> <ul style="list-style-type: none"> • Anti-skid surface • Hand railing • Cautionary footpath paving pattern for level change • Cautionary road marking at sloping streets

List of Pedestrian Improvement Measures for Four Pillars of Walkability – “Making It Enjoyable”

Item	Making It Enjoyable					
	11. Capacity – Sufficient space for pedestrians	12. Comfort – Comfortable walking environment	13. Health – Healthy walking environment	14. Attraction – Pedestrian way as a destination by itself	15. Coordination – Coordinated space allocation for walking and public transport nodes	16. Connection to nature
	<p><u>New footpath width standard</u></p> <ul style="list-style-type: none"> Upgraded LOS targets Integrating link and place considerations in three zone concept <p><u>Reclaiming pedestrian space</u></p> <ul style="list-style-type: none"> Part time/ full time pedestrian street Level surface Narrowing of carriageway Reclaiming on-street parking and loading/unloading space for pedestrian way Building set back <p><u>Decluttering</u></p> <ul style="list-style-type: none"> Minimum use of railings and traffic signs Coordinated street furniture 	<p><u>Weather protection</u></p> <ul style="list-style-type: none"> Covered walkway Building canopy Tree shade Bus shelter Tram shelter 	<p><u>Clean air</u></p> <ul style="list-style-type: none"> Acceptable road side air quality <p><u>Pedestrian thermal comfort</u></p> <ul style="list-style-type: none"> Air ventilation corridor Suitable street trees 	<p><u>Place to dwell</u></p> <ul style="list-style-type: none"> Activity nodes Character streets Public space Seating Outdoor Seating Accommodation <p><u>Quality streetscape</u></p> <ul style="list-style-type: none"> Greening and landscaping Street furniture Public art installation Lighting Paving 	<p><u>Dedicated waiting area for public transport nodes</u></p> <ul style="list-style-type: none"> Bus waiting area Tram waiting area MTR entrance/ station plaza Taxi waiting area 	<p><u>Greening and landscaping along pedestrian way</u></p> <ul style="list-style-type: none"> Street trees Vertical greening Greening of walkway and covered walkway <p><u>Landscaped link along/ to and from green and blue assets</u></p> <ul style="list-style-type: none"> Green spine Green connector Harbourfront/ riverfront promenade

List of Pedestrian Improvement Measures for Four Pillars of Walkability – “Making It Smart”

Item	Making It Smart			
	17. Legibility – Ease of wayfinding through physical signage	18. Interactive planning – Ease of route planning and wayfinding through the use of technology	19. Smart pedestrian infrastructure – Prioritizing pedestrian movement through the use of technology	20. Smart pedestrian planning – Pedestrian Information System and automated collection of pedestrian data and pedestrian environment data through the use of technology
	<u>Wayfinding signage system</u> <ul style="list-style-type: none"> • Extending improved system to all districts 	<u>Walking route search and data</u> <ul style="list-style-type: none"> • HKeMobility App <u>Public transport route search and data</u> <ul style="list-style-type: none"> • HKeMobility App <u>Car parking data</u> <ul style="list-style-type: none"> • HKeMobility App • Parking information system in building 	<ul style="list-style-type: none"> • Intelligent crossing • Crossing for disabled and elderly 	<ul style="list-style-type: none"> • Pedestrian Information System • Automatic pedestrian counter • Automatic collection of pedestrian environment data

10.6 Performance Review

10.6.1 Introduction

10.6.1.1 It refers to tracking and evaluating performance following implementation of the schemes for pedestrian improvement measures. The main reasons for the review are:

- (i) to measure the impacts of schemes;
- (ii) to demonstrate, where appropriate, the effectiveness of schemes;
- (iii) to enable adjustments to policy, strategies and designs; and
- (iv) to assess progress towards targets.

10.6.1.2 This is to identify the actual effects. Monitoring programmes provide meaningful data when necessary. Methods should be robust, designed for repeated uses and consistent so that trends can be derived from the observations.

10.6.2 Considerations of Performance Review

10.6.2.1 Pedestrian surveys are different from vehicular traffic surveys. Some differences are indicated below:

- (i) Accurately monitoring the overall level of pedestrian activities at local level is difficult and expensive. It will be better to undertake selective monitoring of key destinations and journeys, particularly those involved in schemes to promote walking.
- (ii) Pedestrian journeys are usually short, less than one kilometer. The choice of any screen line or cordon is more critical than it would be for surveys of motor vehicles.
- (iii) Pedestrian movements at any one location are likely to show more variety from day to day than flows of motor vehicles. One-day count may provide a useful impression but are unlikely to form a statistically reliable basis for regular monitoring.
- (iv) Manual counts are fairly simple to undertake and can record additional information such as movement (cross and reverse flows), demographic factors (gender, age groups), trip purposes (job-related, non-working, leisure trips for visitors, window shopping), mobility difficulty (with luggage, encumbrances and obvious difficulties with walking), mode(s) used, journey designation, journey origin, and others (accompanied/alone.).
- (v) Daily pedestrian flows are affected by weather. The size of effect appears to be greater than that for motor vehicles.

10.6.2.2 Characteristics of walk journeys include:

- (i) likely to be part of a long journey involving another mode of travel;
- (ii) highly dependent on local facilities and services (which may change over time);
- (iii) someone traveling by car is clearly a car user; but someone on foot may have just stepped off a bus or out of a car; and
- (iv) pedestrians use the streets in various way (Walking activity does not always correspond well with pedestrian journeys of flows. Pedestrian dwell time or density may be more relevant measures in some cases than flows or distance traveled).

10.6.2.3 Conventional methods for reviewing walking-related aspects (pedestrian counts, opinion surveys/ interviews, etc) are available and need not be complicated. However, it is important to define aspects that are relevant. Schemes promoting walking to replace short motorised trips will focus on the modal shares. Concern over the vitality of the central retailing areas will be more interested in monitoring the footfall, dwell time or density of pedestrians on the streets.

10.6.2.4 To gauge performance of the schemes, TPDM Volume 6 Chapter 10 Section 10.4.3 specifying the pedestrian planning objectives could be used as a guideline to review whether the effectiveness of pedestrian planning and pedestrian improvement measures has been achieved along the four pillars of walkability. Means of review could include site observations, pedestrian counts, complaint records, accident records, opinion surveys and other relevant records/surveys as appropriate.

10.7 Development of Pedestrian Wayfinding Signage System for Hong Kong

10.7.1 Introduction

General

10.7.1.1 The purpose of this Section is to provide guidelines on planning and design of pedestrian wayfinding signage system on public roads in Hong Kong. Various types and formats of pedestrian wayfinding signage are introduced in this Section. A 5-step sign placement strategy is also included to assist designers to conduct pedestrian wayfinding signage study, selection of sign types, signing arrangement and coordination with the existing signage system.

10.7.1.2 Signface design requirements of each sign type are set out in Chapter 7 Volume 3 of the TPDM.

Purpose of Provision of Pedestrian Wayfinding Signage

10.7.1.3 The ‘Walk in HK’ initiative identified the need for a new pedestrian-orientated wayfinding signage system to enhance the walkability of Hong Kong by making its streets, neighbourhoods and districts more legible.

10.7.1.4 Wayfinding refers to an on-street signage and information system that inspires and guides people through the public environment and enhances their understanding and experience of the public space. In addition to aiding navigation and legibility of the public environment, the new wayfinding system can ultimately motivate people to walk longer distances, and more frequently, as part of their daily lives.

10.7.2 Family of Pedestrian Wayfinding Signage System

Sign Type

10.7.2.1 The wayfinding sign types can be categorized into:





- (i) Map-based totem and
- (ii) Route marker

Map-based totem

10.7.2.2 Map-based totem should be provided on arrival points, major decision points and dwelling points according to the criteria given in Section 10.7.4. If provided, the map-based totem should be in fixed dimension and include information with beacon, address, directional information for the nearby attractions and destinations, maps and destination index indicating walking times to nearby attractions, areas or destinations.

10.7.2.3 The map-based totem consists of four types of signs including gateway totem, navigation totem, wall-mounted totem and board map totem. The application of each type of map-based totem is summarised in the Table 10.7.2.1.

Table 10.7.2.1
Number of Direction Groups and Destinations for Route Marker

<u>Type of Totem</u>	<u>Dimension</u> (Width x Height x Thickness in mm)	<u>Panels</u> (Dimensions [Width x Height x thickness in mm])	<u>Display Information</u>	<u>Recommended Placement Locations</u>
Gateway Totem 	Fixed dimension of 635 x 2710 x 160	All the individual panel dimensions are fixed, as below: Beacon (605 x 150 x 160) Address & Directional Panel (605 x 930 x 160) Map & Destination Index Panel (605 x 1060 x 160) Base Panel (605 x 410 x 160)	<ul style="list-style-type: none"> - Logo - Address - Directional information - Focus & Wide Map - Destination index (with walking time in minute) - Legend 	Arrival points, dwelling points and major decision points including the main exits to stations and/or transport hubs
Navigation Totem 	Fixed dimension of 370 x 2710 x 160	All the individual panel dimensions are fixed, as below: Beacon (340 x 150 x 160) Address & Directional Panel (340 x 930 x 160) Map & Destination Index Panel (340 x 1060 x 160) Base Panel (340 x 410 x 160)	<ul style="list-style-type: none"> - Logo - Address - Directional information - Focus & Wide Map - Legend 	Alternative to Gateway Totem at limited space
Wall mounted Totem 	Fixed dimension of 950 x 1320 x 75	All the individual panel dimensions are fixed, as below: Beacon (920 x 150) Address & Directional Panel (920 x 550) Map & Destination Index Panel (920 x 605)	<ul style="list-style-type: none"> - Logo - Address - Directional information - Focus & Wide Map - Legend 	Alternative to freestanding totem at limited space and where installation of totem is not possible.
Broad Map Totem 	Fixed dimension of 950 x 2000 x 160	All the individual panel dimensions are fixed, as below: Beacon (920 x 150 x 160) Address & Directional Panel (920 x 234 x 160) Map & Destination Index Panel (920 x 1045 x 160) Base Panel (920 x 410 x 160)	<ul style="list-style-type: none"> - Logo - Address - Focus Map - Destination index (with walking time in minute) - Legend 	Major transport hubs, large public spaces and squares with sufficient area for users dwelling

NOTES :

- (1) LOGO REFERS TO “WALK IN HK”
- (2) PANEL DETAILS REFER TO PARA. 10.7.3.1

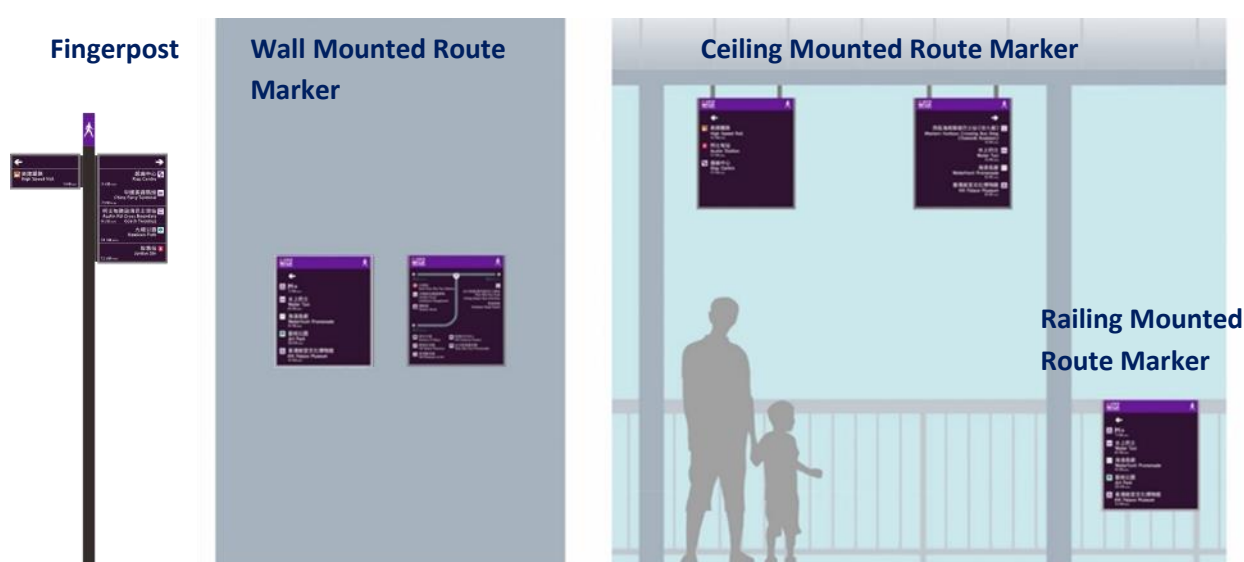

Route Marker

- 10.7.2.4 Route marker is composed of two types of signs including fingerpost and wall / railing / ceiling mounted route marker with high installation flexibility as illustrated in Diagram 10.7.2.1.
- 10.7.2.5 Route marker acts as route confirmation or indicator of an attraction or a place which may be hidden from view of the main walking route. It is used at minor decision point to indicate specific directions and to support simple wayfinding decision-making. This can also be used at major decision point but with site constraint in placing map-based totem sign. A decision point refers to locations where the users are required to make a wayfinding decision to continue along the current route, such as junction on footpath.
- 10.7.2.6 Mounted route marker should be an alternative option for location with limited space, and / or prohibited from installing freestanding finger post, such as subway and footbridge, to deliver directional information to users and providing reassurance along routes.
- 10.7.2.7 On complex footbridge/walkway systems connecting several different attractions / landmarks, the wall / railing / ceiling mounted route marker can be designed in form of a location map to show the neighbourhoods. It is advisable to show neighbourhood names only which are necessary to provide adequate information, in order to achieve clarity and limit the size of the location maps. The locations of route marker at subways and footbridges should be positioned not to block or disturb pedestrian flows and sightlines. Pictograms for neighbours and vertical connection facilities at the exit, such as lifts, escalators or stairs, should be included. More details of the design of pictograms is provided in Volume 3 Chapter 7 Section 7.3.2.

DIAGRAM 10.7.2.1 : ILLUSTRATION OF ROUTE MARKER SIGNAGE

- 10.7.2.8 If provided, the fingerpost's slat and pole would be in fixed dimension, the number of slats contained at each panel would have variants according to actual demand up to maximum 6 slats. Wall / railing / ceiling mounted route marker should be in fixed width with height subject to headroom.
- 10.7.2.9 The application of each type of route marker is summarised in the Table 10.7.2.2.

Table 10.7.2.2
Application of Route Marker

<u>Type of Totem</u>	<u>Dimension</u> (in mm)	<u>Panels</u> (Dimensions [in mm])	<u>Display</u> <u>Information</u>	<u>Recommended</u> <u>Placement Location</u>												
<p>Finger Post</p> 	<p>Fixed dimension of pole at 88.9 diameter x 5 thick G.M.S. C.H.S. x 3440</p> <p>Headroom clearance 2300 shall be maintained</p>	<p>All the individual panel dimensions are fixed, as below:</p> <p>Beacon 88.9 diameter x 305 height</p> <p>Directional Panel with fixed width 530 and height is varying regarding to the number of slats included:</p> <table border="1" data-bbox="675 705 916 1012"> <thead> <tr> <th>Nos.of Slats</th> <th>Height</th> </tr> </thead> <tbody> <tr> <td>2 Slats</td> <td>304</td> </tr> <tr> <td>3 Slats</td> <td>444</td> </tr> <tr> <td>4 Slats</td> <td>584</td> </tr> <tr> <td>5 Slats</td> <td>724</td> </tr> <tr> <td>6 Slats</td> <td>864</td> </tr> </tbody> </table> <p>(i.e. slat height 140 each, up to 6 slats)</p>	Nos.of Slats	Height	2 Slats	304	3 Slats	444	4 Slats	584	5 Slats	724	6 Slats	864	<ul style="list-style-type: none"> - Walking man - Directional information (with walking time in minute) 	<p>Used at minor decision point to indicate specific directions, also could be used at major decision point with site constraints in placing map-based totem.</p>
Nos.of Slats	Height															
2 Slats	304															
3 Slats	444															
4 Slats	584															
5 Slats	724															
6 Slats	864															
<p>Wall / railing / ceiling mounted Route Marker</p> 	<p>Fixed width is 635</p> <p>Height is various and subject to case-by-case review based on site constraints. The preferred height is 715 for directional information arrangement.</p> <p>For ceiling mounted route marker, headroom clearance of 2300 shall be maintained above footway ⁽²⁾.</p> <p>The headroom requirement would be increased to 2.6m for subways / enclosed footbridge longer than 23m.</p> <p>When signs are fixed above a railing or barrier with no pedestrian passage underneath, the headroom can be reduced to 2.0m above the footway ⁽³⁾.</p>	<p>Beacon dimensions are fixed at 605 width x 80 height)</p> <p>Directional Panel with fixed width 605. While the height is various and subject to case-by-case review based on site constraints.</p>	<ul style="list-style-type: none"> - Logo - Directional information (with walking time in minute) 	<p>Apply to a variety of environmental context, such as pedestrian subways and footbridges in Hong Kong, also an alternative option for location that spaces are not available to install fingerpost.</p>												

NOTES :

- (1) LOGO = “WALK IN HK”
- (2) HEADROOM REQUIRED FOR CEILING MOUNTED SIGN IN TPDM VOL. 3 CL. 2.2.3
- (3) HEADROOM REQUIREMENT FOR WALL MOUNTED SIGN IN TPDM VOL. 3 CL. 2.2.3.5

10.7.3 Components of Pedestrian Wayfinding Signage System

Sign Components

- 10.7.3.1 Each component of the pedestrian wayfinding signage has a specific function and delivers different types of information at various scales and levels of detail. The sign components are indicated in Diagram 10.7.3.1 for map-based totem and route markers.

DIAGRAM 10.7.3.1 : SIGN COMPONENTS

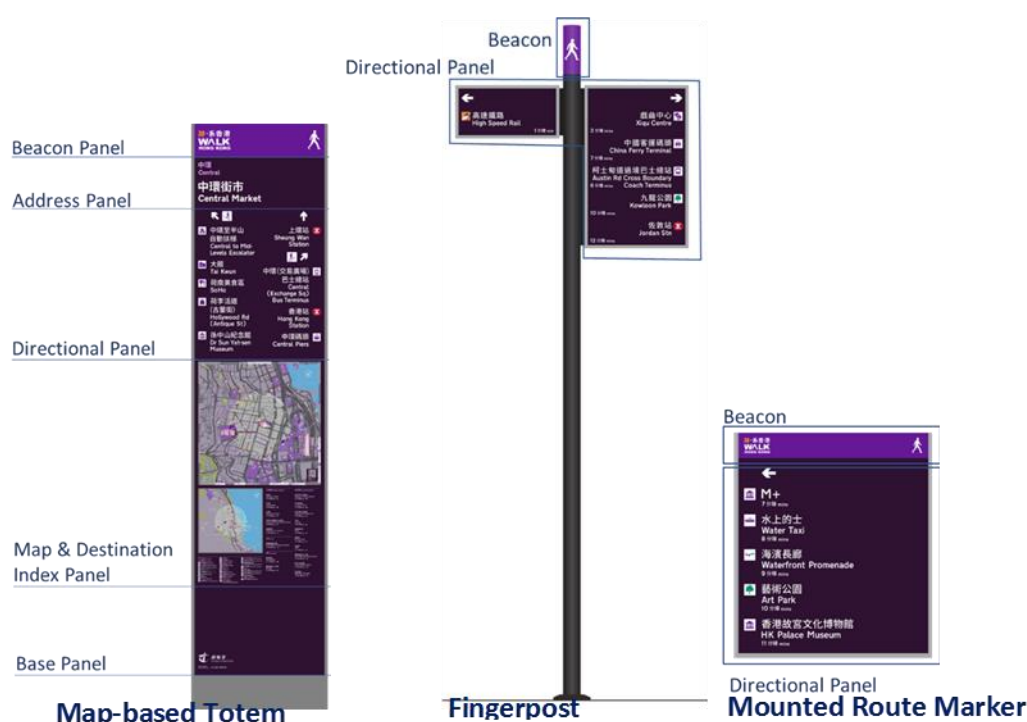

Beacon

- 10.7.3.2 All types of pedestrian wayfinding signage contain a beacon on top. It is highlighted with regal purple colour with a walking man to enhance the sign’s visibility, conspicuousness, and recognition within competing streetscapes.

Address Panel

- 10.7.3.3 All map-based totems contain an address panel below the beacon. The address is to allow the users to acknowledge their current location, detailing the “Sub-District” and “Neighbourhood” that the sign is located in.

- 10.7.3.4 “Sub-District” is reserved for the area name, which is an administrative district of the sign location (e.g. Tsim Sha Tsui) while the “Neighbourhood” is denoted as local identification in vicinity. For further details on “Sub-district” names and application of local destination names, please refer to paragraph 7.3.1.1 – 7.3.1.2 of TPDM Volume 3 Chapter 7; for the selection of “Neighbourhood”, please refer to paragraph 7.3.1.3 – 7.3.1.7 of TPDM Volume 3 Chapter 7.

Directional Panel

- 10.7.3.5 All map-based totems (except board map totem) and route markers contain directional panel which display the neighbourhoods with arrow indicating its direction. It is restricted to high priority neighbourhoods only to keep information concise and legible. Neighbourhoods are grouped according to arrow direction to aid intuitive reading and listed in order of proximity from closest to furthest. Walking minutes should be provided together with the neighbourhood in the panel on route marker.
- 10.7.3.6 Pictograms on directional panels are aligned with the arrows to provide quick-read information, allowing users to immediately identify information without having to read through the full content list, also benefit users who have language difficulties.

Maps and Destination Index Panel

- 10.7.3.7 All map-based totems contain a focus map and a wide map, except broad map totem with only a focus map. The aim of providing these maps is to provide users with rich information to plan their journeys and itineraries. The maps deliver different levels of information – either complementing or working independently of each other depending on the user's requirements. The sample focus map and wide map are illustrated in Diagram 10.7.3.2. These maps will be presented as heads-up mapping as shown in Diagram 10.7.3.3, where the map has been rotated to match the viewer's orientation.

DIAGRAM 10.7.3.2 : FOCUS MAP AND WIDER MAP

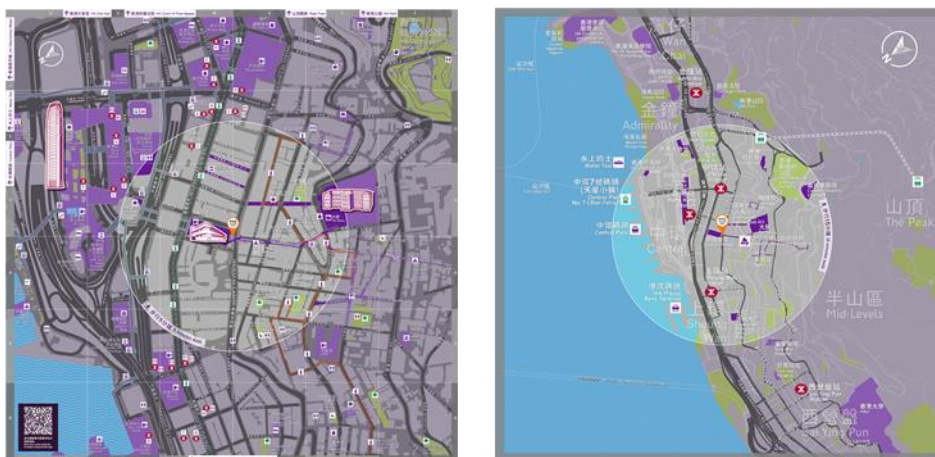

Focus Map

Wider Map

DIAGRAM 10.7.3.3 : HEADS-UP MAPPING



10.7.3.8 Focus Map

- a) A more detailed map to be used for navigation and wayfinding, the focus map concentrates on the user's immediate area that is walkable within a 5- minute radius. It provides the user with their detailed location and orientation in the context of their immediate location.
- b) Landmarks, attractions and services are included for wayfinding purposes, with information relating to the specific geographical and built environment features (e.g. changes in level, pedestrian crossings, subways and footbridges etc.) are included for detailed route planning.
- c) Indicative walking time in minute aid in journey planning, and off map pointers provide additional wayfinding content, connecting with adjacent areas as shown in the wide map.
- d) QR code is available on focus map for users linking to the "HKeMobility" application for a more interactive route planning via personalised digital tools. Smart Mobility Division (SMD) shall be approached 6 months in advance before launch day for necessary data preparation.

10.7.3.9 Wide Map

- a) This map extends to approximately a 15-minute walk circle from the user's location, providing users with their general location in the context of the wider region.
- b) Detailed built environment information is removed to simplify the map and prioritize the relevant content. The wide map is not intended to be used for detail wayfinding; instead, it presents to the user with the surrounding neighborhoods, greenspaces, key landmarks and transport hubs/networks for orientation and mental map building.

10.7.3.10 Destination index as shown in Diagram 10.7.3.4 is located below the focus map to highlight the most popular neighbourhoods situated within the local area with associated grid number displayed in focus map to assist user on searching nearby attractions. The estimated walking time is also provided next to the neighbourhoods for users' onward journey planning.

DIAGRAM 10.7.3.4 : DESTINATION INDEX

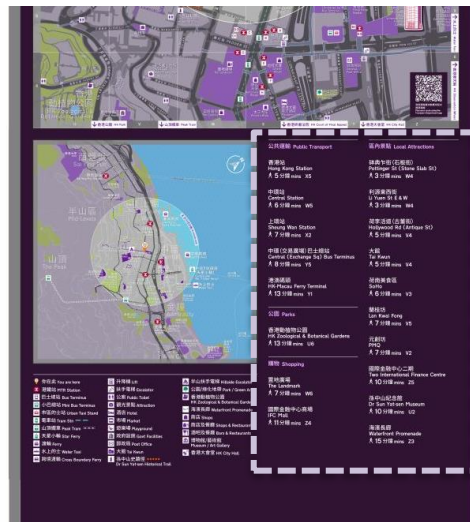

Destination Index

10.7.3.11 Legend, in Diagram 10.7.3.5, would be provided to illustrate the meaning of each pictogram / graphic for supporting whole wayfinding signage.

DIAGRAM 10.7.3.5 : LEGEND

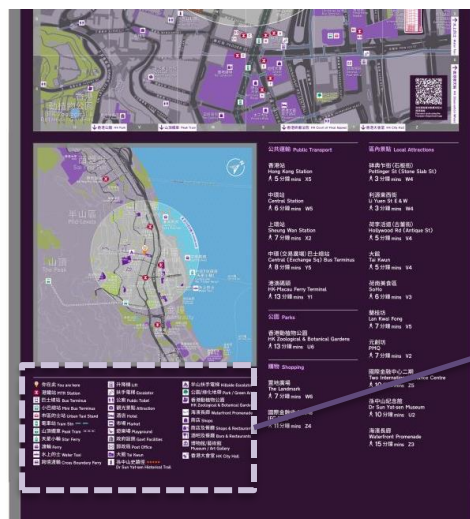

Legend

Base Panel

10.7.3.12 Base panel is applied for map-based totem with a TD logo and the signage ID for identification and inventory purposes.

10.7.4 Sign Placement Strategy

5-Steps Sign Placement Methodology

10.7.4.1 To formulate a sign placement plan, a logical 5-step sign placement methodology has been established. The details of the 5-step process are summarised in Table 10.7.4.1 and demonstration of sign placement is presented as follows.

Table 10.7.4.1
5-Step Sign Placement Methodology

<u>Step</u>	<u>Description</u>
1	Define the study area and identify the major public transport arrival points and landmarks/attractions
2	Classify the touch points across the route network
3	Determination of sign types
4	Review and coordinate with existing signage system and conduct site audit
5	Production of wayfinding signage master plan

Step 1 – Define the study area and identify the major public transport arrival points and landmarks / attractions

Step 1A to define the study area

- 10.7.4.2 The study area for implementation of pedestrian wayfinding signage system should be identified. The extent of study area refers to the limit of sign positioning, while the information on the signs may extend beyond the study area depending on content of individual signs.

Step 1B to identify major public transport arrival points

- 10.7.4.3 Locations where pedestrians will access the study area by public transport should be identified. The public would require pedestrian wayfinding signage to access local information at the arrival point. As a matter of principle, signs should be located at the arrival points and where possible they should be used to provide a great perspective of the area. The major public transport arrival points including public transport interchanges, MTR stations, airport, ferry piers, major bus stops and coach terminals should be identified and plotted on the map for analysis.

Step 1C to identify landmarks / attractions

- 10.7.4.4 This step is to identify key places of interest such as popular landmarks and attractions where the public want to go including sightseeing spots, retail and shopping malls, leisure hubs, parks, and civic amenities. Consideration is particularly given to places that would attract tourist or users who are unfamiliar with the local area for supporting their wayfinding needs.

DIAGRAM 10.7.4.1 : STEP 1 – DEFINE THE STUDY AREA AND IDENTIFY THE MAJOR PUBLIC TRANSPORT ARRIVAL POINTS AND LANDMARKS/ATTRACTIONS

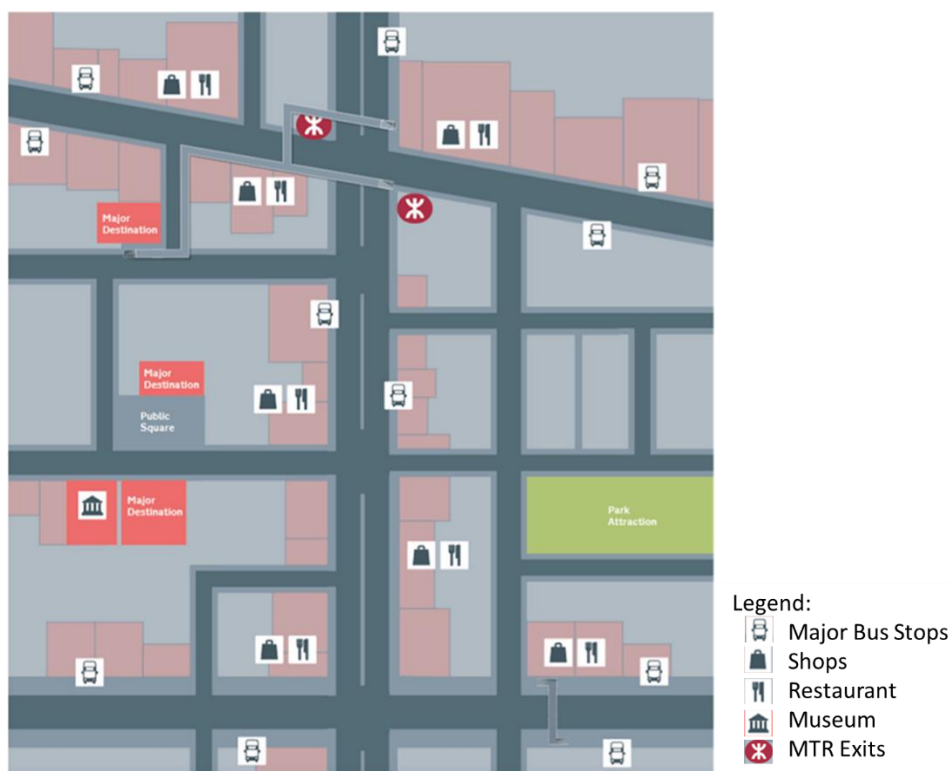

Step 2 – Classify the touch points

- 10.7.4.6 To identify and categorise the wayfinding touch points regarding to the streetscape and characteristic of the study area. These touch points include Arrival Points, Dwelling Points and Decision Points.
- 10.7.4.7 Arrival Points refer the entry points into the area, such as outside transport hubs and major station exits. Users will require a comprehensive level of information to understand the area's layout, connectivity options, as well as to plan their onward journeys.
- 10.7.4.8 Dwelling Points represent large public spaces, squares or hubs where people will benefit from wayfinding information. They are often used as staging posts, either for a break or to plan next stage journey. Wayfinding signs are therefore performing the same function as an Arrival Points and/or Decision Points.
- 10.7.4.9 Decision Points are locations where the users are required to make a wayfinding decision either to continue along the current route or proceeding to other destinations. In complex urban environments such as subway or footbridge connecting with pedestrian route, pedestrians will need wayfinding information to continue their journeys via subway or footbridge. Besides, they also provide directions of relative landmarks/attractions within complex subway or footbridge networks particularly with various exits.
- 10.7.4.10 Sample of Step 2 – Classify the touch points is demonstrated in Diagram 10.7.4.2.

DIAGRAM 10.7.4.2 : STEP 2 – CLASSIFY THE TOUCH POINTS

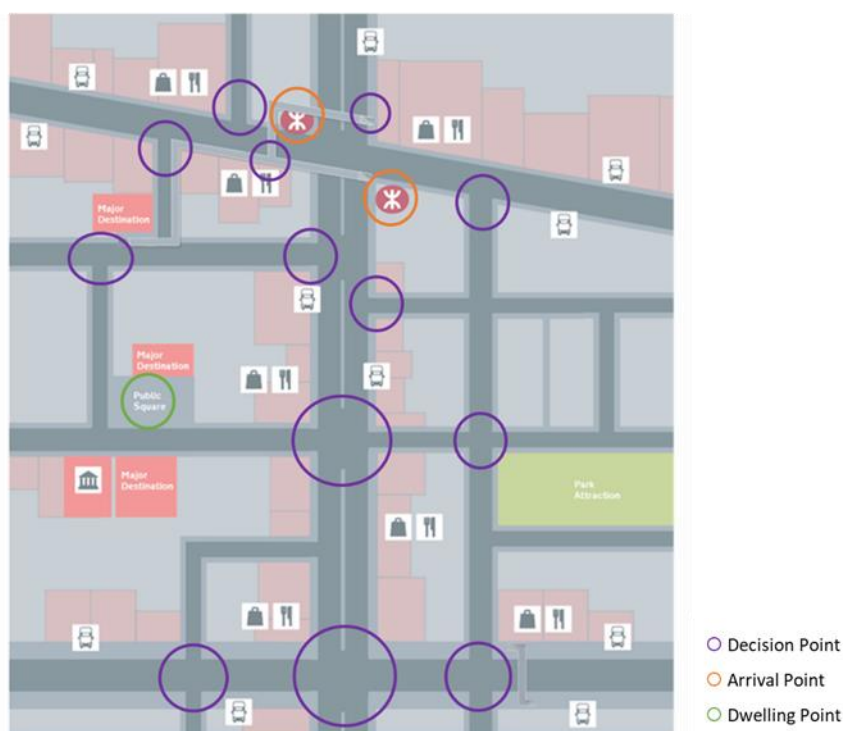

Step 3 – Determination of Sign Types

10.7.4.11 Step 3A - This step assigns the sign typology to each designated touch point with its sign location and orientation based on the following rules as shown in Table 10.7.4.2.

Table 10.7.4.2
Selection of Wayfinding Sign Types

<u>Decision Point</u>	<u>Wayfinding Sign Types</u>
Arrival Points	Gateway totem should be normally suggested, if space is unavailable and limited, navigation totem would be the alternative option. Wall mounted totem would be adopted to cater for various site situations including subways, footbridges and PTIs. Broad map totem would be applied in major transport hubs with large public spaces and sufficient area for users dwelling
Dwelling Points	Broad map totems are used at dwelling points including large public spaces and squares with sufficient area for users dwelling. If space is unavailable and limited, other types of map-based totems, such as gateway totem and navigation totem, can be considered.
Major Decision Point	Gateway totem would be normally suggested, if space is unavailable and limited, navigation totem and fingerpost would be the alternative options. Wall / railing / ceiling mounted route marker can be considered to cater for various site situations including subways and footbridges.
Minor Decision Point	Fingerpost would be normally suggested, if space is unavailable and limited, Wall / railing / ceiling mounted route marker can be considered to cater for various site situations including subways and footbridges.

10.7.4.12 Sample of Step 3 – Selection of Signage is demonstrated in Diagram 10.7.4.3.

DIAGRAM 10.7.4.3 : STEP 3 – DETERMINATION OF WAYFINDING SIGN TYPES AND POSITIONING

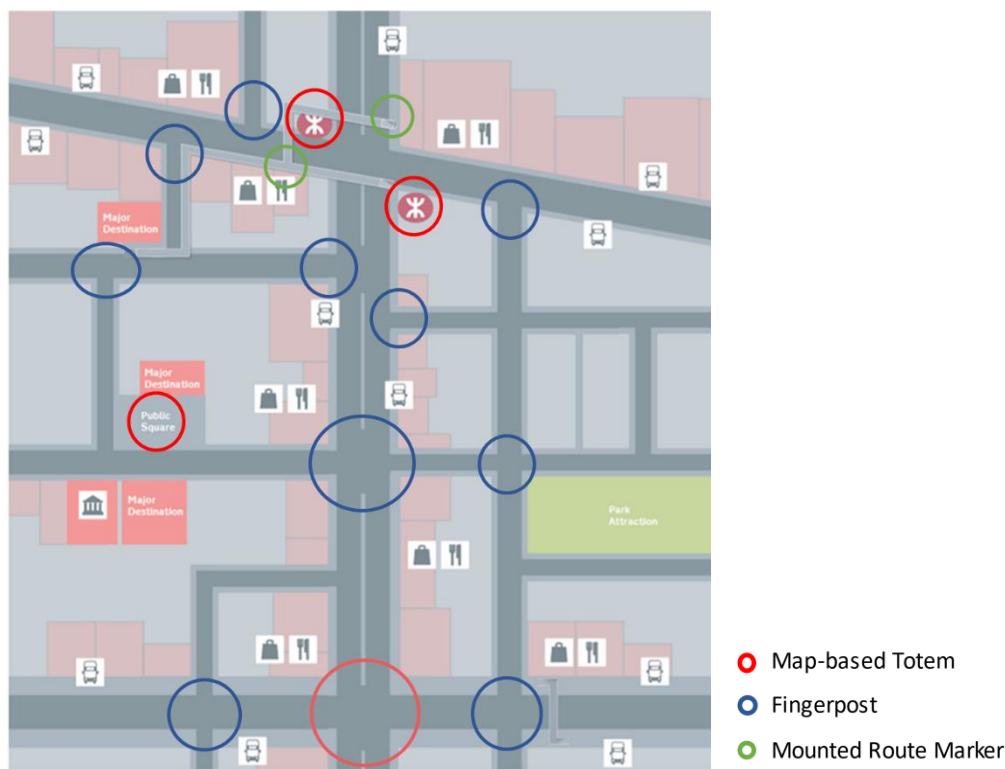

Step 4 – Review and coordination with existing signage and conduct site audit

- 10.7.4.13 The wayfinding sign implementation should collaborate with the existing systems. It is noted that various wayfinding signage system, such as Visitor Signage Improvement Scheme (VSIS) and pedestrian wayfinding signs owned by Tourism Commission, Transport Department and Home Affairs Department, etc., have been implemented over the public realm effectively in built-up areas in Hong Kong. By collaborating and synchronising wayfinding information between the new and existing systems, the effectiveness of wayfinding would be amplified. In this connection, the new wayfinding system should be suitably designed to coordinate with the existing signage systems.
- 10.7.4.14 For instance, the map-based totem, which is one of the sign type of the new wayfinding system, is the key to strengthen the current signage systems in built-up areas. It would be erected at major arrival points / activity nodes for the sake of guiding people through the public environment to their destinations as well as inspiring them to explore the districts, ultimately enhancing their walking experience.
- 10.7.4.15 Meanwhile, review of the necessity for collaborating / integrating / updating / decluttering of the existing signs would be vital for providing continuous support of the whole wayfinding signage system in built-up areas. Some existing signage may have opportunity to be incorporated and consolidated into the new wayfinding signage system. Doubling up of signage is unnecessary and reduces clarity of the wayfinding system. Signage to be consolidated into new wayfinding signage includes VSIS, signage with transport information or local attraction. Other government agencies and institutions have their own existing or proposed wayfinding systems (e.g. LCSD, HAD). These signage locations must be considered in the siting of new signs, avoiding duplication of service provision. New signs are to avoid obscuring other signage with specific purpose such as for barrier-free access routing, toilet etc.
- 10.7.4.16 Whereas the new development areas without wayfinding signs, the methodology of implementation of new wayfinding signage should follow the wayfinding sign types and positioning as defined in Step 3.

10.7.4.17 If new signage is provided, detailed site audit should be conducted to verify the suitability of each proposed sign type and its exact placement, orientation, and mounting method. The checking as tabulated in Table 10.7.4.3 should be carried out.

Table 10.7.4.3
Headroom, Clearance and Limitation for Sign Placement

<u>Type of Totem</u>	<u>Underground Survey</u>	<u>Vertical Clearance</u>	<u>Horizontal Clearance</u>	<u>Other Limitation</u>
Map-based totem ⁽⁴⁾	Required for underground utility checking	N/A	The clear width of the footway should be >3m or LOS C ⁽¹⁾ or above subject to review case by case. The clearance should maintain at least 0.5m and 0.2m from carriageway and railing respectively	Rotation of sign would induce significant effect on map or directional information such that their orientation must be confirmed at an early stage. The preferable position of signage is faced to pedestrian flow . If the signage needs to face parallel to the direction of pedestrian flow due to site constraints, change of sign type or relocate the signage as an alternative solution may be considered.
Fingerpost ⁽⁵⁾	Required for underground utility checking	Minimum of 2.3m headroom clearance should be maintained for fingerpost above footways	The clear width of the footway should be >3m or LOS C ⁽¹⁾ or above subject to case by case review. The elevated directional panel should maintain at least 0.5m and 0.2m clearance from carriageway and railing	The directional panel should align with street network, and should avoid pointing to inaccessible direction, such as pointing to wall/building.
Wall / railing / ceiling mounted route marker ⁽⁶⁾	N/A	Minimum of 2.3m headroom clearance are required for ceiling-mounted signage above footway ⁽²⁾ The headroom requirement would be increased to 2.6m for subways / enclosed footbridge longer than 23m When signs are fixed above a railing or barrier with no pedestrian passage underneath, the headroom can be reduced to 2.0m above the footway ⁽³⁾	A 3m clearance from the ceiling mount sign and staircases would be provided to allow adequate buffer distance between the sign and the steps of staircases to ensure safety.	The panel of ceiling mount sign should be orientated perpendicular to the major pedestrian flow. Appropriate distance with staircase and escalator shall be maintained, such that pedestrians could read the contents when walking at the flat level.

NOTES :

1. LOS C = 23-33 PEDESTRIANS/MINUTE/METRE
2. HEADROOM REQUIRED FOR CEILING MOUNTED SIGN IN TPDM VOL. 3 CL. 2.2.3
3. HEADROOM REQUIREMENT FOR WALL MOUNTED SIGN IN TPDM VOL. 3 CL. 2.2.3.5
4. CLEARANCE AND ALIGNMENT FOR MAP-BASED TOTEMS REFER TO DIAGRAM 10.7.4.4
5. CLEARANCE AND ALIGNMENT FOR FINGERPOST REFER TO DIAGRAM 10.7.4.5
6. CLEARANCE AND ALIGNMENT FOR CEILING MOUNTED ROUTE MARKER REFER TO DIAGRAM 10.7.4.6

DIAGRAM 10.7.4.4 : CLEARANCE AND ALIGNMENT FOR MAP-BASED TOTEM

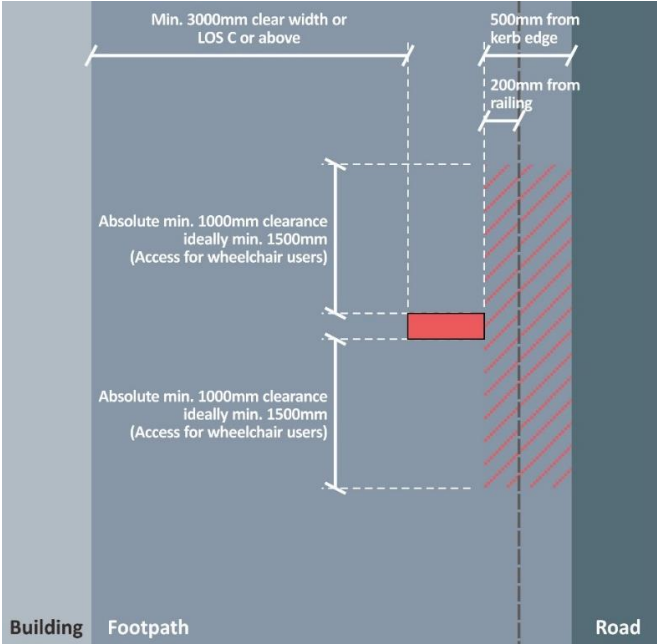

DIAGRAM 10.7.4.5 : CLEARANCE AND ALIGNMENT FOR FINGERPOST

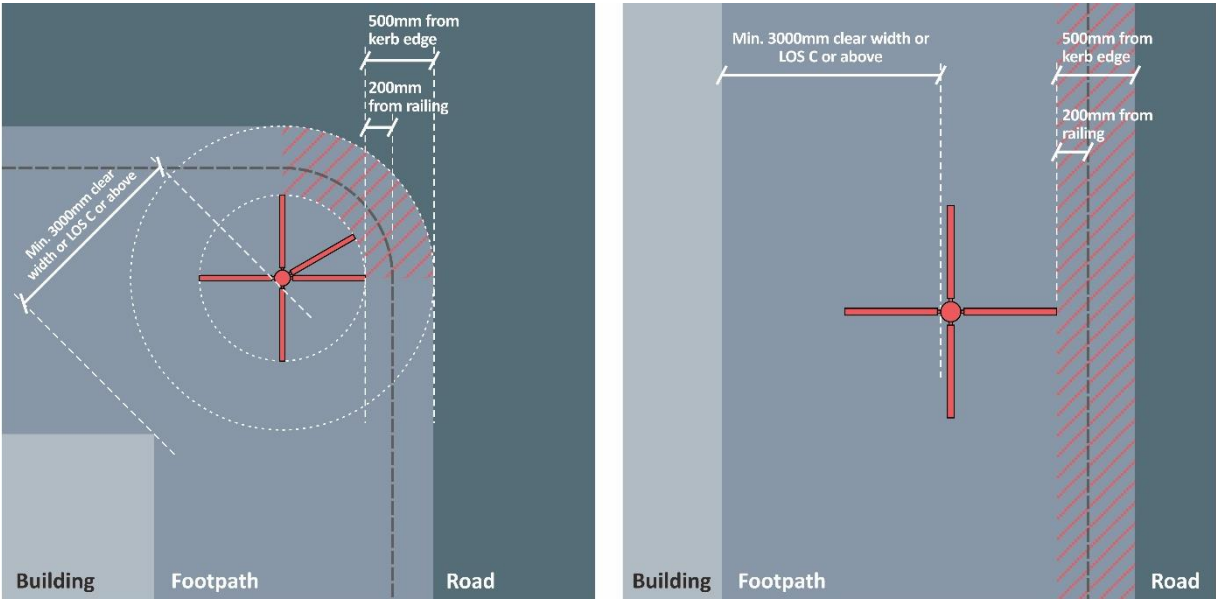
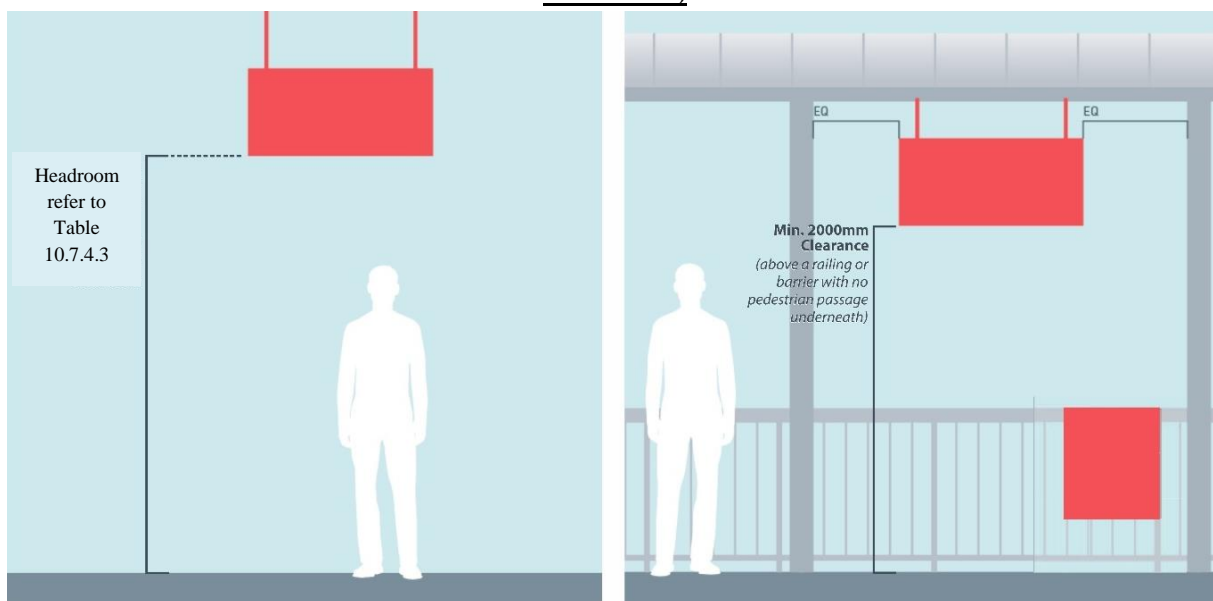

DIAGRAM 10.7.4.6 : SIGNS HEADROOM CLEARANCE (CEILING-MOUNTED ROUTE MARKER)



Step 5 – Production of Wayfinding Signage Master Plan

- 10.7.4.18 Upon completion of the above sign placement Step 1 to Step 4, a set of wayfinding signage master plan should be produced by the Project Office for presentation to and approval by the Project Office and Transport Department. This set of master plan should contain sufficient information, including but not limited to, proposed signage location within the study area, orientation of the signage, proposed trial trench location etc. with sufficient information for further detailed sign face design as required under TPDM Vol 3, Section 7.3.2 as well as decluttering detail where applicable. Major design development, engineering considerations and decisions should be recorded in digital format and submitted to the Project Office and Transport Department for review and record purpose.

10.7.5 Territory-wide Implementation of Pedestrian Wayfinding Signage System

- 10.7.5.1 The territory-wide implementation of the pedestrian wayfinding signage system should cover all areas in Hong Kong.
- 10.7.5.2 Priority of implementation plan is given to the districts with high value of tourist attractions, historical elements, well-known landmarks and commercial hubs where wayfinding information are in needed by public. Districts with compacted transport network, mixed with various attractions / destinations and/or commercial clusters should be prioritized in implementation programme. Major transport nodes including MTR stations and public transport interchanges are major arrival points for visitors and tourists. They are the main target users of wayfinding system. Therefore, districts with the above characteristics would be in top priority. Besides, to accomplish the wayfinding network in pilot areas, i.e. West Kowloon, Central and Sham Shui Po, these districts would be prioritized.
- 10.7.5.3 In each district, the major arrival points, where public arrived the districts via public transports including MTR station exits and public transport interchanges (PTIs), major activity nodes and associated decision points along the walking route would be identified. They are essential for the creation of a comprehensive wayfinding system and to estimate the number of wayfinding sign required along the route. The above estimation forms an important basis for the formulation of territory-wide implementation strategy.

Scope of Works

- 10.7.5.4 The territory-wide implementation of pedestrian wayfinding signage system involves the design, production and installation stages. The major steps are:

10.7.5.5 Design Stage

- (a) Identify suitable location for different sign types
- (b) Carry out onsite inspection for location confirmation
- (c) Design the wayfinding signs according to confirmed locations
- (d) Consultation with relevant stakeholders
- (e) Preparation of design documents and drawings
- (f) If interactive map in HKeMobility is considered required, SMD should be approached in advance for the requirements / specifications of incorporating the associated map data into HKeMobility
- (g) Review and update the implemented new wayfinding signage system to integrate with the up-to-date urban context
- (h) Plan to conduct post-implementation evaluation to solicit public feedback on the new wayfinding signage system if appropriate

10.7.5.6 Production and Installation Stage

- (a) Carry out foundation works
- (b) Production of signage
- (c) Erection of signage
- (d) Declutter / collaborate with existing signage
- (e) Provide the required map data to SMD 6 months in advance, if interactive map in HKeMobility is considered necessary